

AmericanLifelinesAlliance

A public-private partnership to reduce risk to utility and transportation systems from natural hazards

Guidelines for the Design of Buried Steel Pipe

July 2001

(with addenda through February 2005)

ASCE

American Society of Civil Engineers



AmericanLifelinesAlliance

A public-private partnership to reduce risk to utility and transportation systems from natural hazards

Guideline for the Design of Buried Steel Pipe

July 2001

www.americanlifelinesalliance.org

This report was written under contract to the American Lifelines Alliance, a public-private partnership between the Federal Emergency Management Agency (FEMA) and the American Society of Civil Engineers (ASCE). This report was reviewed by a team representing practicing engineers and academics.

Acknowledgments

The following people (with their affiliations) contributed to this report.

G. A. Antaki, Co-chairman	WSRC, Aiken, SC
J. D. Hart, Co-chairman	SSD, Inc., Reno, NV
T. M. Adams	Stevenson and Associates, Cleveland, OH
C. Chern	Bechtel, San Francisco, CA
C. C. Costantino	City College of New York, New York, NY
R. W. Gailing	Southern California Gas Co., Los Angeles, CA
E. C. Goodling	Parsons Energy & Chemicals, Reading, PA
A. Gupta	North Carolina State University, Raleigh, NC
R. Haupt	Pressure Piping Engineering, Foster City, CA
A. P. Moser	Utah State University, Logan, UT
M. O'Rourke	Rensselaer Polytechnic Institute, Troy, NY
S. Peterson	Lakehead Pipe Line Co., Bay City, MI
M. Rosenfeld	Kiefner & Associates, Worthington, OH
J. E. Thomas	S/D Engineers, Pittsburgh, PA

Table of Contents

1.0	Introduction	1
1.1	Project Objective	1
1.2	Cautions	2
1.3	Notations	3
2.0	Internal Pressure	9
2.1	Sources of Internal Pressure	9
2.2	Example	9
3.0	Vertical Earth Load	10
3.1	Applied Load	10
3.2	Deflection and Stress Under Soil Load.....	11
3.3	Example 1	11
3.4	Example 2	11
3.5	Example 3	11
3.6	Figure	12
4.0	Surface Live Loads	13
4.1	Applied Loads.....	13
4.2	Ovality and Stress	15
4.2.1	Ovality	15
4.2.2	Through-Wall Bending.....	15
4.2.3	Crushing of Side Walls	16
4.2.4	Ring Buckling	16
4.2.5	Fatigue	17
4.3	Example	17
4.4	Figures	19
5.0	Surface Impact Loads	21
5.1	Maximum Impact Load	21
5.2	Penetration and PPV.....	21
5.3	Example	22
5.4	Figure	23
6.0	Buoyancy	24
6.1	Applied Load	24
6.2	Pipe Stress	24
6.3	Example	25
6.4	Figures	26
7.0	Thermal Expansion	27
7.1	Expansion Loads and Stresses.....	27
7.2	Example	27
7.3	Figure	28

8.1	Applied Load	29
8.2	Evaluation.....	29
8.3	Example	30
8.4	Figures	32
9.0	Movement at Pipe Bends	41
9.1	Pipe Movement.....	41
9.2	Evaluation.....	41
9.3	Figure	42
10.0	Mine Subsidence	43
11.0	Earthquake.....	44
11.1	Seismic Wave Propagation	44
11.2	Permanent Ground Displacement	45
11.3	Example	46
11.4	Figures	48
12.0	Effects of Nearby Blasting.....	50
12.1	Applied Stress	50
12.2	Evaluation.....	52
12.3	Example	52
12.4	Figure	54
13.0	Fluid Transients.....	55
13.1	Applied Loads.....	55
13.2	Evaluation.....	56
13.3	Example	56
14.0	In-Service Relocation	58
14.1	Applied Load	58
14.2	Evaluation.....	59
14.3	Example	60
14.4	Figures	61
	References and Bibliography.....	62
	Appendix A: Suggested Acceptance Criteria	66
	Appendix B: Soil Spring Representation	68
B.1	Axial Soil Springs	68
B.2	Lateral Soil Springs	69
B.3	Vertical Uplift Soil Springs.....	70
B.4	Vertical Bearing Soil Springs.....	71
B.5	References.....	71
B.6	Figures	72

List of Figures

Figure 3.1-1	Soil Prism Above Pipe.....	12
Figure 4.1-1	Surface Load and Transmitted Pressure.....	19
Figure 4.2-1	Ovality of Pipe Cross Section.....	19
Figure 4.2-2	Through-Wall Bending Stress	20
Figure 4.2-3	Crushing of Side Wall.....	20
Figure 4.2-4	Ring Buckling of Pipe Cross Section.....	20
Figure 5.1-1	Fall of a Heavy Object on Ground Surface.....	23
Figure 6.1-1	Resultant Buoyancy Load on Pipe	26
Figure 6.1-2	Distributed Buoyancy Load on Pipe	26
Figure 7.1-1	Bending Moment at Buried Pipe Bend Due to Constrained Pipe Expansion	28
Figure 8.2-1	Pipeline Thaw Settlement Scenario	32
Figure 8.2-2	Finite Element Model of Pipeline Settlement.....	33
Figure 8.3-1	Buried Pipeline Subject to Vertical Fault Movement.....	34
Figure 8.3-2(a)	Vertical Displacement Profile Along the Pipeline	35
Figure 8.3-2(b)	Axial Displacement Profile Along the Pipeline.....	35
Figure 8.3-2(c)	Axial Force Profile Along the Pipeline	36
Figure 8.3-2(d)	Bending Moment Diagram Along the Pipeline.....	36
Figure 8.3-3(a)	Top Fiber Axial Strain Diagram Along the Pipeline	37
Figure 8.3-3(b)	Bottom Fiber Axial Strain Diagram Along the Pipeline	37
Figure 8.3-3(c)	Pipe Curvature Diagram Along the Pipeline.....	38
Figure 8.3-3(d)	Pipe Rotation Diagram Along the Pipeline	38
Figure 8.3-4(a)	Force in Longitudinal Soil Springs Along the Pipeline.....	39
Figure 8.3-4(b)	Displacement in Longitudinal Soil Springs Along the Pipeline	39
Figure 8.3-4(c)	Force in Transverse Soil Springs Along the Pipeline	40
Figure 8.3-4(d)	Displacement in Transverse Soil Springs Along the Pipeline.....	40
Figure 9.1-1	Model of Overbend.....	42
Figure 11.2-1	Direction of Ground Movement Δ and Zones of Pipe Axial Tension and Compression for Longitudinal PGD where L is Small to Moderate.....	48
Figure 11.2-2	Direction of Ground Movement Δ and Zones of Pipe Axial Tension and Compression for Longitudinal PGD where the Length of the PGD Zone is Large	48
Figure 11.2-3	Transverse PGD With Spatial Extend W and Amount of Movement Δ	49
Figure 14.1-1	Pipeline Lowering with Transition Lengths L_1	61
Figure 14.1-2	Pipeline Lowering with Transition Lengths L_1 and Obstruction Length L_2	61
Figure B.1	Pipeline Modeling Approach	72
Figure B.2	Plotted Values for the Adhesion Factor, α	73
Figure B.3	Values of N_{qh} and N_{ch} of Hansen 1961	74
Figure B.4	Ranges for Values of N_{qv} and N_{cv} (from Trautman and O'Rourke, 1983).....	75
Figure B.5	Plotted Values of Bearing Capacity Factors (N_q , N_c , and N_γ).....	76

List of Tables

Table 4.1-1	Live Loads	13
Table 4.1-2	Impact Factor (F) versus Height of Cover	14
Table 8.3-1	Soil Resistance Properties for Example Problem	31
Table 11.1-1	Peak Ground Velocity	45
Table 12.1	Empirical Coefficients for Estimating Velocity and Stress	51
Table 12.2	Normalization Factors for Common Types of Explosives	51
Table B.1	Friction factor f for Various External Coatings.....	69

1.0 Introduction

The American Lifelines Alliance (ALA) was formed in 1998 under a cooperative agreement between the American Society of Civil Engineers (ASCE) and the Federal Emergency Management Agency (FEMA). In 1999, ALA requested a group of civil and mechanical engineers, listed in the Acknowledgements, to prepare a guide for the design of buried steel pipe. The group prepared the guidelines presented in this report, with an emphasis on the fundamental design equations suitable for hand calculations, and where necessary, guidance for finite element analysis.

1.1 Project Objective

The purpose of this guide is to develop design provisions to evaluate the integrity of buried pipe for a range of applied loads. The provisions contained in this guide apply to the following kinds of buried pipe:

- New or existing buried pipe, made of carbon or alloy steel, fabricated to ASTM or API material specifications.
- Welded pipe, joined by welding techniques permitted by the ASME code or the API standards.
- Piping designed, fabricated, inspected and tested in accordance with an ASME B31 pressure piping code. These codes are: B31.1 power piping, B31.3 process piping, B31.4 liquid hydrocarbon pipelines, B31.5 refrigeration piping, B31.8 gas transmission and distribution piping, B31.9 building services piping, B31.11 slurry piping, and ASME Boiler and Pressure Vessel Code, Section III, Division 1 nuclear power plant piping.
- Buried pipe and its interface with buildings and equipment.

Each section in the guide addresses a different form of applied load:

- 2.0 Internal Pressure
- 3.0 Vertical Earth Loads
- 4.0 Surface Live Loads
- 5.0 Surface Impact Loads
- 6.0 Buoyancy
- 7.0 Thermal Expansion
- 8.0 Relative Pipe-Soil Displacement
- 9.0 Movement at Pipe Bends
- 10.0 Mine Subsidence
- 11.0 Earthquake
- 12.0 Effects of Nearby Blasting

13.0 Fluid Transients

14.0 In-Service Relocation

A dimensionally consistent set of units is used throughout, unless units are specifically called out. For typical pressure piping applications, the pipe demand calculations for some of these load conditions can lead to inconsequential stress levels. Nevertheless, the procedures for estimating pipe stress demands due to these loads are presented for completeness. As designers gain experience using these calculations, they will more efficiently identify which load conditions are relevant to their particular application. Examples of calculations for computing various measures of demand on buried pipes are presented at the end of each section, whenever possible.

The designer should appropriately combine the effects of concurrent loads when evaluating the adequacy of the buried pipe. Appendix A: Suggested Acceptance Criteria contains guidance for the evaluation of the buried pipe capacity. The equations used to calculate soil resistance are common to several loading conditions and are provided in Appendix B: Soil Spring Representation.

The provisions of this document have been written in permissive language and offer the user a series of options or instructions but do not prescribe a specific course of action. Significant judgment must be applied by the user.

1.2 Cautions

The guide does not address the effects of material degradation, such as corrosion and cracks, or damage incurred during transport and installation or by third parties, such as dents or gouges. The guide does not address regulatory compliance, which may impose additional requirements or restrictions on the design. The guide does not address company-specific practices such as right-of-way or minimum spacing for limiting collateral damage.

1.3 Notations

$(EI)_{eq}$	= equivalent pipe wall stiffness per inch of pipe length
A	= metal cross-section area of pipe
A	= distance to nearest explosive charge
A_f	= pipe flow area
B'	= empirical coefficient of elastic support
C	= soil cohesion
C	= depth of soil cover above pipe
c_L	= sonic velocity in liquid
C_p	= seismic compression wave velocity in soil
C_s	= apparent propagation velocity of seismic waves
D	= outside diameter
D	= offset distance between a concentrated surface load and the centerline of the pipe
DMF	= dynamic magnification factor of impulsive load from water hammer
dP	= pressure rise due to rapid valve closure in a pipeline carrying fluid
D_l	= deflection-lag factor for computing pipe ovality
E	= modulus of elasticity of pipe
E'	= modulus of soil reaction
E_C	= modulus of pipeline coating elasticity
E_L	= modulus of pipeline lining elasticity
F	= unbalanced impulsive load along each straight section of pipe
F_b	= upward force due to buoyancy per unit length of pipe
FS	= factor of safety
G	= gravitational constant
G	= soil shear modulus
H	= depth of cover to pipe centerline

H_f	= drop height
h_w	= distance between the top of the pipe and the ground water table (zero if the water table is below the top of the pipe)
I	= moment of inertia of pipe wall
I_C	= moment of inertia of pipe coating
I_L	= moment of inertia of pipe lining
K	= bedding constant
K_I	= coefficient for achieving specific level of conservatism in estimating pipe stresses from blasting
K_i	= empirical coefficients for estimating blast loads ($i = 1$ to 6)
K_o	= coefficient of earth pressure at rest
k	= coefficient of penetration
L	= length of pipe span
L_I	= transition length for in-service pipeline relocation
L_b	= length of pipe span in the buoyancy zone
L_s	= support span for in-service pipeline relocation
L_T	= total length of trench for in-service pipeline relocation
L_v	= distance from a valve to an upstream pressure source
N	= factor to normalize explosives to ANFO (94/6) explosive
$N1$	= number of explosive charges in a row
$N2$	= number of rows of explosive charges
N_c	= vertical downward soil bearing capacity factor
N_{ch}	= horizontal soil bearing capacity factor for clay
N_{cv}	= vertical upward soil bearing capacity factor for clay
N_q	= vertical downward soil bearing capacity factor
N_{qh}	= horizontal soil bearing capacity factor for sand
N_{qv}	= vertical upward soil bearing capacity factor for sand
N_γ	= vertical downward soil bearing capacity factor
P	= total vertical pressure load on pipe
p	= internal pipe pressure

P_a	= pressure from weight of a falling object distributed over the impact area
PGA	= peak ground acceleration
PGV	= peak ground velocity
P_{max}	= maximum impact load at the ground surface
p_o	= atmospheric pressure
P_p	= vertical pressure transmitted to pipe from a concentrated load
PPV	= peak particle velocity from surface impact
P_s	= concentrated load at the ground surface
P_u	= maximum horizontal soil bearing capacity
P_v	= vertical soil trench pressure acting on the top of the pipe
P_{vu}	= vertical earth load pressure for undisturbed placement conditions
Q_u	= maximum vertical upward soil bearing capacity
R	= pipe radius
r	= charge standoff distance
R_c	= radius of curvature associated with pipeline deformation imposed by in-service pipeline relocation
R_{gcg}	= distance to geometric center of a grid of explosive charges
R_{gcl}	= distance to geometric center of a line of explosive charges
r_o	= equivalent radius of impact object
R_s	= standoff distance
R_w	= water buoyancy factor
s	= in-line spacing of explosive charges
S	= ASME allowable hoop stress
S_A	= $F(1.25S_c + 0.25S_h)$
S_{allow}	= allowable stress for in-service pipeline relocation
S_c	= allowable stress at ambient temperature
S_h	= allowable stress at operating temperature
$SMYS$	= specified minimum yield stress

t	= pipe wall thickness
T_1	= installation temperature
T_2	= maximum operating temperature
t_c	= valve closing time
T_u	= peak friction force at pipe-soil interface
U	= peak radial ground velocity produced by blasting
V	= impact velocity
V_g	= peak ground velocity
V_s	= shear wave velocity of near-surface soils
w	= total unit weight of pipe with contents, force/length
W	= weight of falling object
W_{act}	= actual explosive weight
W_c	= weight of pipe contents per unit length
W_{eff}	= effective explosive weight
W_p	= weight of pipe per unit length
W_s	= scaled explosive weight
W_w	= weight of water displaced by pipe
X	= elevation difference between original pipeline and lowered pipeline
x_p	= penetration depth of falling object
y	= deflection at midpoint of pipe due to buoyancy
Y	= ASME B31.1 time-dependent factor
Z	= elastic modulus of pipe cross-section
Δ_p	= horizontal displacement to develop P_u
Δ_{qd}	= vertical displacement to develop Q_d
Δ_{qu}	= vertical displacement to develop Q_u
Δ_t	= axial displacement to develop T_u
Δ_v	= change in liquid velocity from initial flow rate to zero
Δ_y	= vertical deflection of pipe from vertical loads

α	= coefficient of thermal expansion
α	= adhesion factor for clay
α	= factor applied to C_s in estimating ground strain from wave propagation
β	= angle between the pipeline and a row of explosive charges
δ	= interface friction angle for cohesionless soils
ε_{15}	= allowable longitudinal compressive strain associated with 15% ovalization of pipe cross section
ε_a	= pipeline axial strain
ε_b	= pipeline bending strain
ε_c	= allowable longitudinal (axial or bending) compression strain
γ	= total dry unit weight of fill
$\bar{\gamma}$	= effective unit weight of soil
γ_d	= dry unit weight of soil
γ_w	= unit weight of water
λ	= wavelength
ρ	= soil mass density
ρ_f	= density of fluid carried by the pipe
σ	= pipeline stress from blasting
σ_a	= pipeline axial stress
σ_b	= through-wall bending stress
σ_b	= pipeline bending stress
σ_{be}	= factored pipeline bending stress from blasting
σ_{bf}	= stress caused by buoyancy
σ_{bs}	= pipeline bending stress associated with the pipeline spanning between lift or support points
σ_{bt}	= maximum bending stress due to thermal expansion
σ_{bw}	= through-wall bending stress
σ_c	= longitudinal compressive stress

- σ_h = hoop stress from internal pressure
- σ_{LC} = longitudinal compressive stress caused by a temperature differential
- σ_{lp} = longitudinal stress due to internal pressure
- σ_u = ultimate strength of pipe steel
- σ_{wb} = longitudinal stress from water hammer
- σ_y = yield stress for the pipe steel

2.0 Internal Pressure

2.1 Sources of Internal Pressure

The internal pressure to be used in designing a piping system for liquid, gas, or two-phase (liquid-gas or liquid-vapor) shall be the larger of the following:

- The maximum operating pressure, or design pressure of the system. Design pressure is the largest pressure achievable in the system during operation, including the pressure reached from credible faulted conditions such as accidental temperature rise, failure of control devices, operator error, and anticipated over-pressure transients such as waterhammer in liquid lines.
- The system hydrostatic or pneumatic test pressure.
- Any in-service pressure leak test.

The internal pressure design of a buried pipe and its corresponding above-ground pipe derive from the same equation.

2.2 Example

A 6-inch seamless carbon steel pipe, ASTM A106 Grade B material, is buried at a chemical process plant. The pipe is designed to the ASME B31.3 Code, with a design pressure of 500 psi and a maximum design temperature of 100°F. The ASME B31.3 allowable stress for the ASTM A106 Grade B at 100°F is $S = 20,000$ psi. The minimum wall thickness of the buried pipe is:

(2-1)

$$t = \frac{pD}{2(SE + pY)}$$

where:

- t = minimum wall thickness required by ASME B31.3, in
- D = pipe outside diameter = 6.625 in
- S = ASME B31.3 allowable stress at the design temperature = 20,000 psi
- E = quality factor = 1.0 for seamless pipe
- p = design pressure, psi
- Y = ASME B31.3 temperature dependent factor = 0.4

The calculated thickness t is 0.08 inches. Then add a corrosion allowance and a fabrication tolerance allowance (12.5% for ASTM A106 material) to obtain the minimum required pipe wall thickness. Note that this process for calculating the pipe wall thickness is identical to the design of a corresponding above-ground piping.

3.0 Vertical Earth Load

3.1 Applied Load

Vertical earth load is primarily a consideration for non-operating conditions of buried steel pipe when the pipeline is under no internal pressure. Under most operating conditions, the external earth pressure can be neglected since it is insignificant in comparison to the internal pipe pressure. Vertical earth load is an important consideration when designing piping casings used for rail and road crossings.

For the purpose of calculating earth loads on a buried pipe, a steel pipe is considered flexible and design procedures for flexible pipes apply. For flexible pipes placed in a trench and covered with backfill, the earth dead load applied to the pipe is the weight of a prism of soil with a width equal to that of the pipe and a height equal to the depth of fill over the pipe, as shown in Figure 3.1-1. This approach is followed for both trench and embankment conditions.

For conditions where the pipeline is above the water table, an upper-bound estimate of the pipe pressure resulting from earth dead load can be obtained using Equation 3-1.

$$P_v = \gamma C \quad (3-1)$$

where:

- P_v = earth dead load pressure on the conduit
- γ = total dry unit weight of fill
- C = height of fill above top of pipe

For conditions where the pipe is located below the water table, the effect of soil grain buoyancy can be included in the earth load pressure using Equation 3-2.

$$P_v = \gamma_w h_w + R_w \gamma_d C \quad (3-2)$$

where:

- P_v = earth dead load pressure on the conduit
- γ_d = dry unit weight of backfill
- C = height of fill above top of pipe
- h_w = height of water above pipe
- γ_w = unit weight of water
- R_w = water buoyancy factor = $1 - 0.33(h_w/C)$

If the pipe is jacked into undisturbed and unsaturated soil instead of being placed in a trench and covered with backfill, then soil friction and cohesion combine to greatly reduce the earth load on the pipe when compared to the prism load. A conservative estimate of the earth load on pipe jacked in undisturbed soil is given as follows [Moser]:

$$P_{vu} = P_v - 2c \frac{C}{D} \quad (3-3)$$

where:

- P_{vu} = vertical earth load pressure for undisturbed placement conditions
- c = soil cohesion (ranges from 0 psf for loose, dry sand to 1,500 psf for hard clay)
- D = pipe outer diameter

3.2 Deflection and Stress Under Soil Load

The effects of soil loads on pipe stresses and pipe ovality in cross-sections are evaluated in conjunction with surface loads in Section 4.2.

3.3 Example 1

The earth load pressure on a pipeline buried 10 feet underground, with a total unit weight of 120 lb/ft³ is:

$$P_v = \left(120 \frac{\text{lb}}{\text{ft}^3}\right)(10\text{ft}) = 1,200\text{psf}$$

3.4 Example 2

For a pipe buried 10 feet underground with a dry unit weight of 100 lb/ft³, the earth load pressure is:

$$P_v = \left(100 \frac{\text{lb}}{\text{ft}^3}\right)(10\text{ft}) = 1,000\text{psf}$$

If the soil is saturated with the water table reaching the surface, the water pressure alone is:

$$P_v = \left(62.4 \frac{\text{lb}}{\text{ft}^3}\right)(10\text{ft}) = 624\text{psf}$$

If soil and water were to act together, the sum of pressure loads would be 1624 lb/ft²; however, because of the buoyancy of the soil in water, the actual total pressure load is:

$$P_v = \left(62.4 \frac{\text{lb}}{\text{ft}^3}\right)(10\text{ft}) + (1 - 0.33) \cdot \left(100 \frac{\text{lb}}{\text{ft}^3}\right) \cdot (10\text{ft}) = 1294\text{psf}$$

3.5 Example 3

A 30-inch diameter pipe is jacked 10 feet underground into undisturbed medium clay with a total unit weight of 120 pounds per cubic foot. The cohesion coefficient c is estimated to be 500 psf. Check the vertical earth load pressure using Equations 3-1 and 3.3:

$$P_v = \left(120 \frac{\text{lb}}{\text{ft}^3}\right)(10\text{ft}) = 1,200\text{psf}$$

$$P_{vu} = 1200 \frac{\text{lb}}{\text{ft}^2} - 2(500 \frac{\text{lb}}{\text{ft}^2}) \left(\frac{10 \text{ ft}}{30 \text{ in}} \right) \left(\frac{12 \text{ in}}{1 \text{ ft}} \right) = -2800 \frac{\text{lb}}{\text{ft}^2} < 0$$

Since the vertical earth load pressure must be greater than or equal to zero, there is no vertical earth load on the pipe.

3.6 Figure

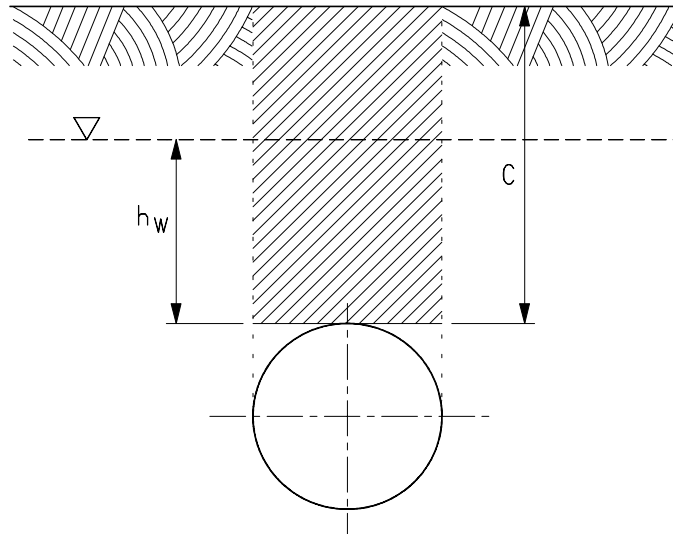

Figure 3.1-1 Soil Prism Above Pipe

4.0 Surface Live Loads

4.1 Applied Loads

In addition to supporting dead loads imposed by earth cover, buried pipes can also be exposed to superimposed concentrated or distributed live loads. Large concentrated loads, such as those caused by truck-wheel loads, railway car, locomotive loads, and aircraft loads at airports are of most practical interest.

Depending on the requirements of the design specification, the live-load effect may be based on AASHTO HS-20 truck loads, Cooper E-80 railroad loads or a 180 kip airplane gear assembly load, as indicated in Table 4.1-1. The values of the live load pressure P_p are given in psi and include an impact factor $F' = 1.5$ to account for bumps and irregularities in the travel surface. Other impact factors are listed in Table 4.1-2.

Note: Live-load depends on the depth of cover over the pipe and becomes negligible for HS-20 loads when the earth cover exceeds 8 feet; for E-80 loads when the earth cover exceeds 30 feet; and for airport loads when the earth cover exceeds 24 feet.

Live load transferred to pipe, lb/in ²				Live load transferred to pipe, lb/in ²			
Height of cover, ft	Highway H20*	Railway E80†	Airport‡	Height of cover, ft	Highway H20*	Railway E80†	Airport‡
1	12.50	--	--	14	§	4.17	3.06
2	5.56	26.39	13.14	16	§	3.47	2.29
3	4.17	23.61	12.28	18	§	2.78	1.91
4	2.78	18.40	11.27	20	§	2.08	1.53
5	1.74	16.67	10.09	22	§	1.91	1.14
6	1.39	15.63	8.79	24	§	1.74	1.05
7	1.22	12.15	7.85	26	§	1.39	§
8	0.69	11.11	6.93	28	§	1.04	§
10	§	7.64	6.09	30	§	0.69	§
12	§	5.56	4.76	35	§	§	§
				40	§	§	§

Notes:

- * Simulates a 20-ton truck traffic load, with impact
- † Simulates an 80,000 lb/ft railway load, with impact
- ‡ 180,000-pound dual-tandem gear assembly, 26-inch spacing between tires and 66-inch center-to center spacing between fore and aft tires under a rigid pavement 12 inches thick, with impact
- § Negligible influence of live load on buried pipe

Table 4.1-1 Live Loads

Installation Surface Condition				
Height of cover, ft	Highways	Railways	Runways	Taxiways, aprons, hardstands, run-up pads
0 to 1	1.50	1.75	1.00	1.50
1 to 2	1.35	1.50	1.00	1.35
2 to 3	1.15	1.50	1.00	1.35
Over 3'	1.00	1.35*	1.00	1.15†

Notes:

* Refer to data available from American Railway Engineering Association (AREA)

† Refer to data available from Federal Aviation Administration (FAA)

Table 4.1-2. Impact Factor (F') versus Height of Cover

For live-loads other than the AASHTO truck, the Cooper rail and the 180 kips aircraft gear assembly loads, the pressure P_p applied to the buried pipe by a concentrated surface load P_s , without impact, as shown in Figure 4.1-1, can be calculated using Boussinesq's equation:

$$P_p = \frac{3P_s}{2\pi C^2 \left[1 + \left(\frac{d}{C} \right)^2 \right]^{2.5}} \quad (4-1)$$

where:

P_p = pressure transmitted to the pipe

P_s = concentrated load at the surface, above pipe

C = depth of soil cover above pipe

d = offset distance from pipe to line of application of surface load

The pressure P_p must be increased for the fluctuating nature of surface line loads by multiplying by the impact factor F' given in Table 4.1-2.

When a surcharge load is distributed over the ground surface area near a pipeline, it is possible that the external surcharge may cause lateral or vertical displacement of the soil surrounding the buried pipeline. In this case, additional information, such as a specialized geotechnical investigation, may be needed to determine if the pipeline could be subjected to soil displacement. A detailed investigation may be in order if the distributed surcharge load over an area larger than 10 square feet exceeds the values tabulated below for the weight of material placed or height of soil fill added over the pipeline.

500 psf or 5 feet of fill – for pre-1941 pipelines

1,000 psf or 10 feet of fill – for pipelines with 12-inch diameters or larger

1,500 psf or 15 feet of fill – for pipelines smaller than 12 inches in diameter

4.2 Ovality and Stress

4.2.1 Ovality

A buried pipe tends to ovalize under the effects of earth and live loads, as illustrated in Figure 4.2-1. The modified Iowa deflection formula may be used to calculate the pipe ovality under earth and live loads:

$$\frac{\Delta y}{D} = \frac{D_l K P}{\left(\frac{(EI)_{eq}}{R^3} + 0.061 E' \right)} \quad (4-2)$$

where:

D = pipe outside diameter, inches

Δy = vertical deflection of pipe, inches

D_l = deflection lag factor (~1.0-1.5)

K = bedding constant (~0.1)

P = pressure on pipe due to soil load P_V plus live load P_P , psi

R = pipe radius, inches

$(EI)_{eq}$ = equivalent pipe wall stiffness per inch of pipe length, in./lb.

E' = modulus of soil reaction, psi

The pipe wall stiffness, $(EI)_{eq}$, is the sum of the stiffness of the bare pipe, lining (subscript L) and coating (subscript C).

$$(EI)_{eq} = EI + E_L I_L + E_C I_C \quad (4-3)$$

where:

$$I = \frac{t^3}{12}$$

t = wall thickness of pipe, lining, or coating

The modulus of soil reaction E' is a measure of the stiffness of the embedment material surrounding the pipe. E' is actually a hybrid modulus, being the product of the modulus of the passive resistance of the soil and the radius of the pipe. Values of E' vary from close to zero for dumped, loose, fine-grained soil to 3000 psi for highly compacted, coarse-grained soil. Recent studies show that the confined compression modulus can be used in place of E' .

4.2.2 Through-Wall Bending

Under the effect of earth and surface loads, the through-wall bending stress in the buried pipe, distributed as shown in Figure 4.2-2, is estimated according to (4-4):

$$\sigma_{bw} = 4E \left(\frac{\Delta y}{D} \right) \left(\frac{t}{D} \right) \quad (4-4)$$

where:

σ_{bw} = through-wall bending stress

$\Delta y/D$ = pipe ovality

D = outside diameter of pipe

t = pipe wall thickness

E = modulus of elasticity of pipe

4.2.3 Crushing of Side Walls

The burial depth should be sufficient that the pressure P on the pipe due to the earth and surface load is less than that causing the crushing of the side wall (see Figure 4.2-3) .

For buried pressure-steel piping and pipelines, with D/t typically smaller than 100, and a yield stress larger than 30,000 psi, crushing of the sidewall is quite unlikely.

4.2.4 Ring Buckling

If the soil and surface loads are excessive, the pipe cross-section could buckle as shown in Figure 4.2-4.

Appendix A evaluates ring buckling, which depends on limiting the total vertical pressure load on pipe to:

$$\frac{1}{FS} \sqrt{32R_w B' E' \frac{(EI)_{eq}}{D^3}}$$

where:

FS = factor of safety

= 2.5 for $(C/D) \geq 2$

= 3.0 for $(C/D) < 2$

C = depth of soil cover above pipe

D = diameter of pipe

R_w = water buoyancy factor = $1 - 0.33(hw/C)$, $0 < hw < C$

hw = height of water surface above top of pipe

B' = empirical coefficient of elastic support (dimensionless)

B' as given AWWA Manual 11, *Steel Pipe—A Guide for Design and Installation*:

$$B' = \frac{1}{1 + 4e^{(-0.065 \frac{C}{D})}} \quad (4-6)$$

In steel pipelines, buckling typically occurs when the ovality reaches about 20%. Other construction and code requirements typically limit the amount of permissible cross section ovality for new steel pipelines to much smaller values (e.g., 3% in API RP-1102).

4.2.5 Fatigue

Where buried pipe is subject to large cyclic surface loads, as in the case of pipe crossing under railroad tracks or highways, Federal, state or local regulations usually specify a minimum burial depth. These typically vary from 1 to 6 feet, depending on the type of crossing, the type of excavation (rock or normal excavation), the pipe diameter, and the consequence of failure [ASME B31.4, ASME B31.8, 49 CFR Part 192 and Part 195, API RP-1102]. For example, API RP-1102 Steel Pipeline Crossing Railroads and Highways, Sixth edition, April 1993, specifies a minimum depth of cover of 6 feet under railroad tracks and 4 feet under highway surfaces.

If the pipe is buried with less than two feet of cover, the continual flexing of the pipe may cause a breakup of the road surface. If the pipe is mortar lined or coated, the deflection limit due to the cyclic live load should be limited to an amplitude of 1%.

4.3 Example

A standard, 24-inch diameter carbon steel pipe with flexible lining and coating and wall thickness $t = 0.375$ -inch (moment of inertia $I = 1943 \text{ in}^4$), crosses beneath a road. The maximum design surface load is $P_s = 10,000$ pounds. The pipe is buried 3 feet (36 inches) underground, above the water table, in soil with a total unit weight of 100 lb/ft^3 with a modulus of soil reaction E' of 500 psi. Determine the stresses in the pipe for the case of zero internal pressure.

The soil pressure on the pipe is:

$$P_v = 100 \frac{\text{lb}}{\text{ft}^3} 3 \text{ ft} \left(\frac{1 \text{ psi}}{144 \text{ psf}} \right) = 2.1 \text{ psi}$$

The pressure on the pipe due to a 10,000 pound surface load directly over the pipe ($d = 0$) is:

$$P_p = \frac{3(10000 \text{ lb})}{2\pi(36 \text{ in})^2 \left[1 + \left(\frac{0}{36 \text{ in}} \right)^2 \right]^{2.5}} = 3.7 \text{ psi}$$

With an impact factor of 1.15, the total live load is $1.15(3.7) = 4.3 \text{ psi}$.

Therefore, the total applied pressure on the pipe is:

$$P = 2.1 \text{ psi} + 4.3 \text{ psi} = 6.4 \text{ psi}$$

The moment of inertia of the pipe wall per inch of circumference is the moment of inertia of a strip 3/8-inch wide and 1 inch long.

$$I = (1/12) (1) (3/8)^3 = 0.00439 \text{ in}^4/\text{in}$$

The pipe ovality is:

$$\frac{\Delta y}{D} = \frac{1.5(0.1)6.4}{\left(\frac{29(10)^6 0.00439}{12^3} + 0.061(500) \right)} = 0.009$$

The through-wall bending stress due to ovalization is:

$$\sigma_{bw} = 4(29)10^6 (0.009) \left(\frac{0.375}{24} \right) = 16,313$$

The critical ring buckling pressure is calculated as follows:

$$B' = \frac{1}{1 + 4e^{(-0.065 \frac{36}{24})}} = 0.216$$

$$P_c = \sqrt{32(1)0.216(500) \frac{29(10)^6 0.00439}{24^3}} = 178 \text{ psi}$$

4.4 Figures

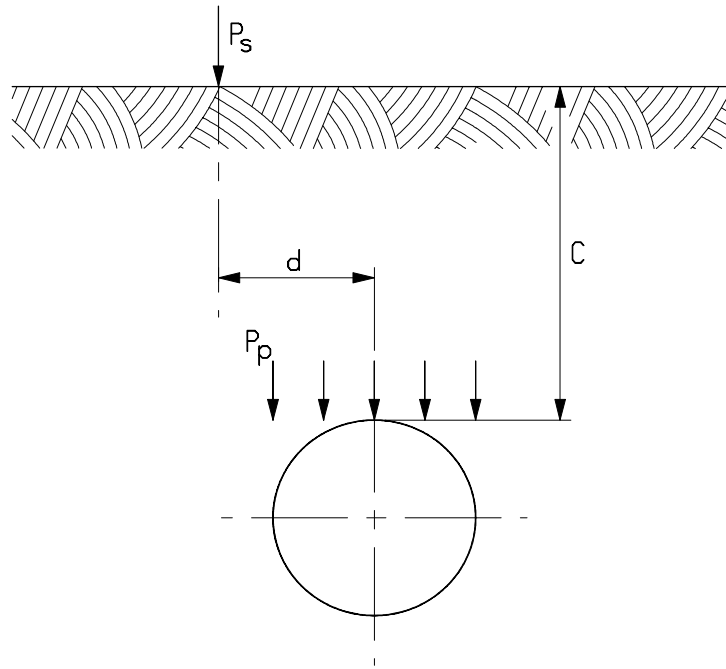

Figure 4.1-1 Surface Load and Transmitted Pressure

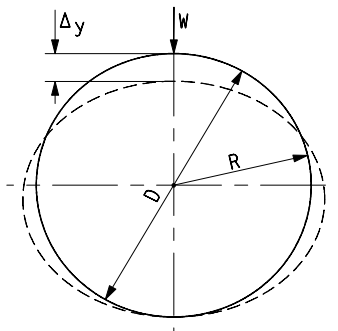

Figure 4.2-1 Ovality of Pipe Cross Section

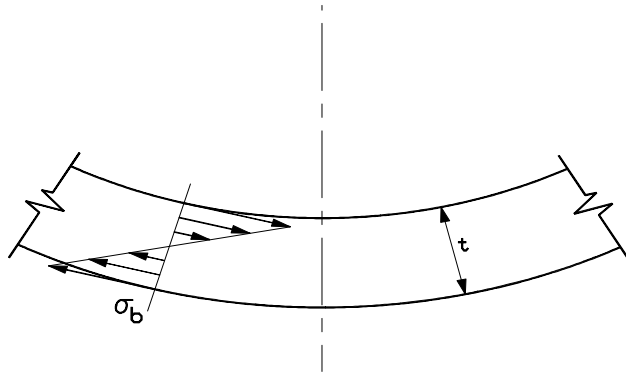

Figure 4.2-2 Through-Wall Bending Stress

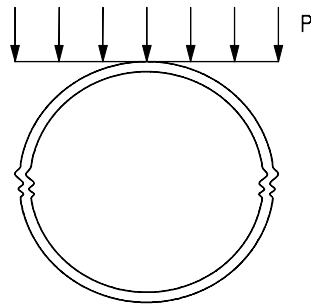

Figure 4.2-3 Crushing of Side Wall

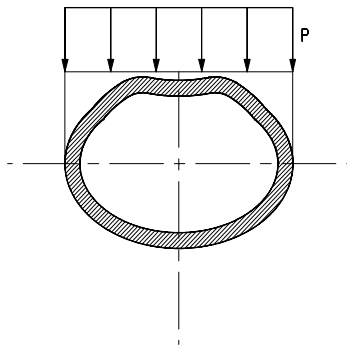

Figure 4.2-4 Ring Buckling of Pipe Cross Section

5.0 Surface Impact Loads

5.1 Maximum Impact Load

The impact loads described in this section are those resulting from large weights falling from significant heights. In this case, the use of an impact factor F' , as applied in Section 4, is not sufficient to estimate the effect of the impact load on the buried pipe. The surface impact load due to the weight W of a fallen object (as shown in Figure 5.1-1) is:

$$P_{\max} = \sqrt{\frac{32WH_f Gr_o}{\pi^2(1-\nu)}} \quad (5-1)$$

where:

- P_{\max} = maximum load at the soil surface, pounds
- W = weight of falling object, pounds
- H_f = drop height, inches
- r_o = least horizontal radius of the falling body, inches
- ν = Poisson's ratio for soil
- G = soil shear modulus, psi

For large strains, near the region of impact, the shear modulus is one-tenth the low amplitude shear modulus, or:

$$G = \frac{\rho V_s^2}{10} \quad (5-2)$$

where:

- V_s = shear wave velocity of near surface soils, inches/second
- ρ = mass density of near surface soil, lb.sec²/in⁴

5.2 Penetration and PPV

For impact near the pipe location, the increased pressure transmitted to the pipe can be evaluated as described in Section 4 where P_{\max} is the applied surface load. This evaluation considers the ovality, through-wall bending, side wall crushing, and ring buckling. In addition, the burial depth should be sufficient to guard against ground penetration by falling objects. The penetration depth can be estimated by:

$$x_p = kP_a \log\left(1 + \frac{V^2}{215,000}\right) \quad (5-4)$$

where:

- x_p = penetration depth, feet
- P_a = weight per unit impact area, psf
- V = impact velocity (equal to $\sqrt{2gH_f}$), feet per second
- k = coefficient of penetration whose empirical values are 0.0367 for sandy soil, 0.0482 for soil with vegetation and 0.0732 for soft soil

For impacts at larger distances from the pipe location, wave propagation is the primary cause of deformation in the buried pipe. For such situations, the peak particle velocity can be calculated [Mayne] as follows:

$$PPV = 8 \left[\frac{\sqrt{WH_f}}{d} \right]^{1.7} \quad (5-4)$$

where:

- PPV = peak particle velocity, inches per second
- W = weight of falling object, tons
- H_f = drop height, feet
- d = shortest distance from point of impact to centerline of pipe, feet

The calculated value of peak particle velocity can then be used for evaluation, using, for example, the procedures given in the section on blast loads.

5.3 Example

Consider the ground impact due to a 15-foot fall of a large heat exchanger being lifted during construction. The heat exchanger weighs 420 tons (840,000 lb). The impact area has a 6 foot diameter. The soil density is 110 lb/ft³, its Poisson ratio is 0.37, and the shear wave velocity is 833 ft/sec = 10,000 in/sec.

The weight of the falling object is $W = 840,000$ pounds, the drop height is $H_f = 180$ inches, the equivalent radius of the impact area is $r_o = 36$ inches, the soil unit weight is $\gamma = 110$ lb/ft³, the mass density is $\rho = \gamma / g$, the soil's Poisson ratio is $\nu = 0.37$, the shear wave velocity of near surface soils is $V_s = 10,000$ inches per second, which leads to:

$$\begin{aligned} \rho &= 0.0001647 \text{ lb-sec}^2/\text{in}^4 \\ G &= \rho V_s^2 / 10 = 1647 \text{ psi} \\ P_{max} &= 6,793,000 \text{ lb} \end{aligned}$$

To calculate the penetration depth, we first determine the velocity at impact:

$$V = (2gH_f)^{0.5} = [2(32.2)(15)]^{0.5} = 31 \text{ ft/sec}$$

The impact pressure is:

$$P = P_{max} / (\pi r_o^2) = 6,793,000 / (\pi 36^2) = 1668 \text{ psi}$$

The weight per unit impact area is:

$$P = W / (\pi r_o^2) = 840,000 / (\pi 36^2) = 206 \text{ psi}$$

For sandy soil the coefficient of penetration is $k \sim 0.0367$. Consequently, the penetration depth is calculated as:

$$x_p = (0.0367)(29,709) \log(1 + 31^2 / 215,000) = 2.1 \text{ ft}$$

5.4 Figure

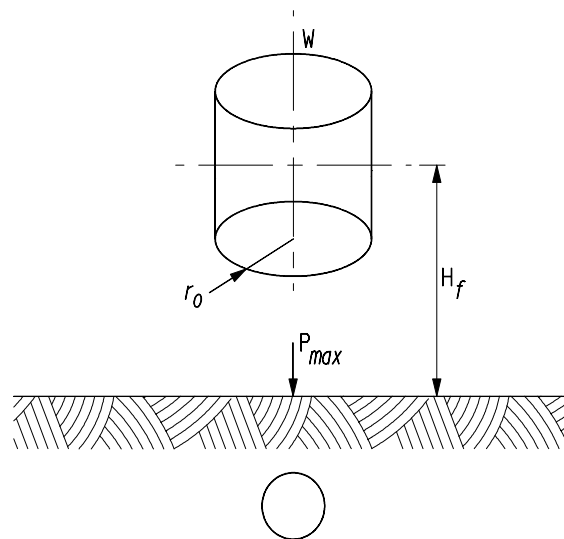

Figure 5.1-1 Fall of a Heavy Object on Ground Surface

6.0 Buoyancy

6.1 Applied Load

Net upward force occurs on buried pipe when the buoyancy force created by the pipe below the water table (the level of standing water in the soil) exceeds the combined downward weight of the pipe and soil column above the pipe. Figure 6.1-1 illustrates the forces on a buried pipe installed below the water table.

In order to calculate the largest upward force, the designer should consider the buried pipe to be empty—filled with air or gas—during installation and testing periods. The weight of the surrounding fluid depends upon the soil density and the level of the water table relative to the buried pipe.

The upward force imposed on a straight, buried, welded carbon-steel pipe from the water table being above the pipe is:

$$F_b = W_w - [W_p + W_c + (P_v - \gamma_w h_w)D] \quad (6-1)$$

where:

- D = outside pipe diameter
- F_b = upward force due to buoyancy per unit length of pipe
- P_v = earth pressure, defined in Section 3
- W_w = weight of water displaced by pipe per unit length of pipe
- W_p = weight of pipe per unit length of pipe
- W_c = weight of pipe contents per unit length of pipe

Note: To simplify calculations, the adherence of the soil to the pipe walls is neglected.

6.2 Pipe Stress

For relatively short sections of buried pipe, the longitudinal (beam bending) stress induced in the pipe by buoyancy forces can be approximated by σ_{bf} :

$$\sigma_{bf} = \frac{F_b L^2}{10Z} \quad (6-2)$$

where:

- σ_{bf} = stress caused by buoyancy forces
- Z = section modulus of the pipe cross section
- L = length of pipe span in the buoyancy zone

For longer sections of pipe, the pipe can exhibit cable action as well as the beam action described above in resistance to the upward buoyancy force.

To provide additional resistance against buoyancy, ballasts such as concrete coating, concrete weights, or gravel filled blankets can be utilized, or the pipe may be anchored using screw anchors, for example.

6.3 Example

A gas pipe is buried 2 feet (24 inches) underground. The pipe has a 48-inch diameter and a 0.5-inch pipe wall thickness. The dry soil density is 80 lb/ft³. As a result of flooding, the water table has risen to the ground surface over a well defined span length of 25 feet along a pipeline route (similar to Figure 6.1-2). Check for pipe buoyancy. If it exists, estimate the pipe stress due to the buoyancy loading.

The weight of water displaced by the pipe is:

$$W_w = 62.4 \cdot \pi \cdot 4^2 / 4 = 784.1 \text{ lb/ft}$$

The weight of pipe and contents is:

$$W_p + W_c = 253.9 + 0 = 253.9 \text{ lb/ft}$$

The effective weight of soil above the pipe (see Section 2.0) is:

$$W_s = D(P_v - \gamma_w \cdot h_w) = 4 [62.4 \cdot 2 + (1 - 0.33) (2 / 2) (80) (2) - 62.4 \cdot 2] = 428.8 \text{ lb/ft}$$

The net upward force exerted on the pipe (per Equation 6.1) is:

$$F_b = 784.1 - 253.9 - 428.8 = 101.4 \text{ lb/ft}$$

A net upward buoyancy force of 101.4 lb/ft exists in this case. An estimate of the bending stress due to a buoyant length of 25 feet is obtained using Equation 6-2 with $I=21,045 \text{ in}^4$ or $Z = 877 \text{ in}^3$, as follows:

$$\sigma_{bf} = \frac{F_b L^2}{10Z} = 101.4 (25 \cdot 12)^2 / (10 \cdot 876.9) = 1041 \text{ psi}$$

6.4 Figures

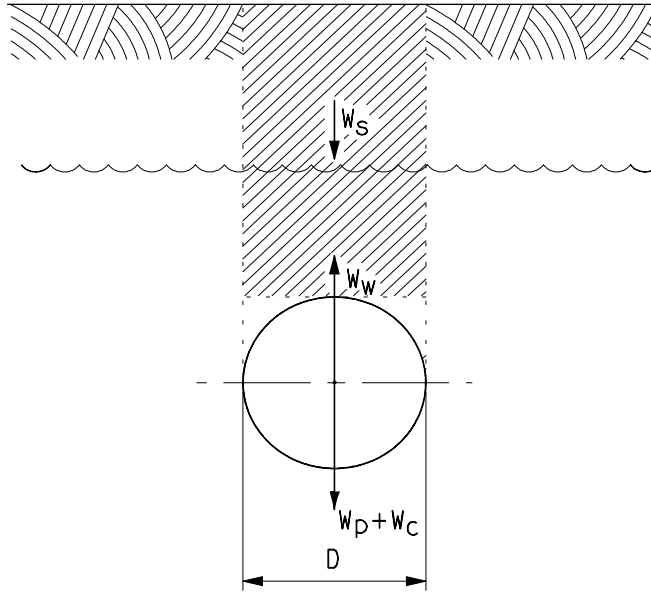

Figure 6.1-1 Resultant Buoyancy Load on Pipe

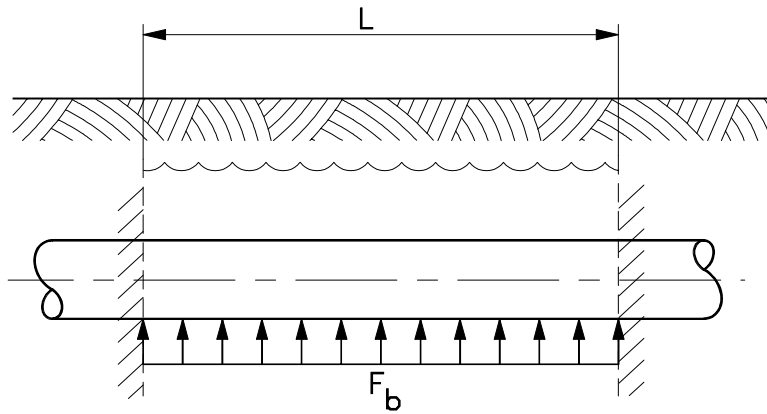

Figure 6.1-2 Distributed Buoyancy Load on Pipe

7.0 Thermal Expansion

7.1 Expansion Loads and Stresses

The axial stress and anchor reactions in buried pipe subject to temperature differential may be conservatively estimated by assuming that the pipe is sufficiently long for the pipe/soil friction to fully restrain the pipe. In this case, the buried pipe is described as “fully restrained.” The maximum compressive thermal stress in a fully restrained pipe is calculated by:

$$\sigma_c = E\alpha(T_2 - T_1) - \nu\sigma_h \quad (7-1)$$

where:

σ_t = compressive longitudinal stress due to temperature differential, psi

E = modulus of elasticity of steel, psi

α = coefficient of thermal expansion, in/in/°F

T_2 = maximum operating temperature, °F

T_1 = installation temperature, °F

ν = Poisson’s ratio for steel

σ_h = hoop stress due to internal pressure, psi

The axial load F_a in the pipe or the axial load at an anchor due to this temperature differential is:

$$F_a = \sigma_t A \quad (7-2)$$

where:

A = metal cross section of pipe

Because soil is not infinitely stiff, a hot pipe will tend to expand at pipe bends, as shown in Figure 7.1-1, causing stresses at the bend. This effect can be analyzed with a finite element model of pipe and soil springs. For pipe behavior that is nearly elastic, such as pipe stresses below yield and soil loads less than the maximum values defined in Appendix B, manual calculations of the type suggested in ASME B31.1 *Non-mandatory Appendix VII* can be used in place of a finite element analysis. The soil properties used may be calculated following the guidelines in Appendix B of the document.

7.2 Example

Consider a buried pipe with the following parameters:

Outside diameter D	=	12.75 inches
Wall thickness t	=	0.375 inch
Cross sectional area A	=	14.57 in ²
Moment of inertia I_P	=	279.3 in ⁴
σ_y	=	35,000 psi

S_y	=	35,000 psi
E	=	29.5×10^6 psi
α	=	6.345×10^{-6} in/in °F
ν	=	0.3
Material	=	seamless carbon steel SA-106, Grade B

The pipe is installed in a trench about 3 pipe diameters in depth, covered with compacted backfill, and subjected to the following conditions:

Operating temperature T_2	=	140°F
Ambient temperature T_1	=	70°F
Internal pressure P	=	100 psig

The hoop stress is:

$$S_H = PD / (2t) = (100)(12.75) / [2(0.375)] = 1,700 \text{ psi}$$

The maximum, fully restrained longitudinal compressive stress is:

$$S_L = E\alpha(T_2 - T_1) - \nu S_H = (29.5 \times 10^6)(6.345 \times 10^{-6})(140 - 70) - 0.3(1,700) = 12,592 \text{ psi}$$

The corresponding axial load is:

$$F = S_L A = (12,592)(14.57) = 183,465 \text{ lb}$$

7.3 Figure

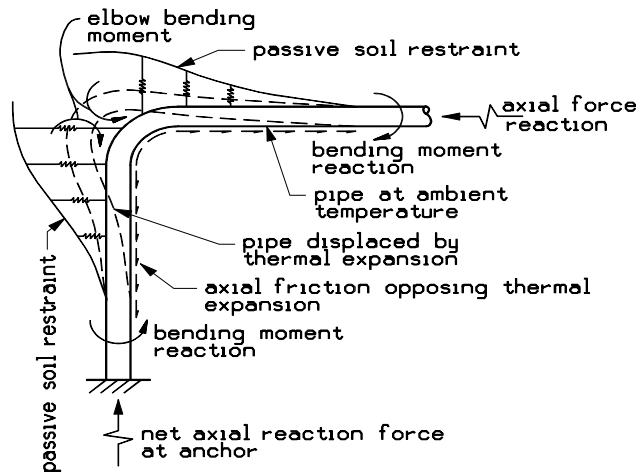

Figure 7.1-1 Bending Moment at Buried Pipe Bend Due to Constrained Pipe Expansion

8.0 Relative Pipe-Soil Displacement

8.1 Applied Load

Under the effects of ground movements or large pipeline loads like those from a large thermal differential, buried pipes may be subject to large bending and tensile loads. Sources of ground movement can include differential soil settlement, fault displacement or lateral spread displacement in earthquakes, landslide displacement, frost heave or thaw settlement, etc. The following sections of this document discuss several of these sources of ground displacement in more detail. The measurement or prediction of ground displacement requires special expertise and is beyond the scope of these guidelines. The approach to evaluating pipeline response typically requires finite element analyses that account for non-linear soil and pipeline behavior. This approach is addressed in this section and is similar for all cases of imposed ground displacement.

8.2 Evaluation

As noted above, differential movement of the soil in which a pipeline is buried can result in significant pipe deformations due to pipe curvature and axial force effects. Soil movement can be taken as the upper bound of pipe displacement. Displacements due to earth settlement are typically monotonic and do not influence the fatigue life. For such cases, the ASME B31 code indicates that a large displacement stress may be acceptable provided that “excessive localized strain” is avoided. However, the ASME B31 codes provide no further recommendations. This implies that a strain or deformation criteria should be considered, accounting for inelastic pipe behavior.

Strain limits are typically used to guard against localized wrinkling or tensile fracture at girth welds while allowing for some controlled level of pipe steel yield. Appropriate deformation limits such as strain or curvature limits can be established based on testing and detailed analysis (e.g., fitness for purpose evaluation). In light of these observations, it is not possible to develop simple design formulas for differential soil movements based on elastic stress analysis procedures.

For discussion purposes, Figure 8.2-1 shows an idealization of a pipeline exposed to thaw settlement. Thaw settlement occurs when a warm pipeline thaws unstable frozen soil below the pipe. Downward settlement of the pipe is produced by thawing and consolidating thaw-unstable soil (see Figure 8.2-1). The pipeline spans over a finite length section of settling soil between two adjacent thaw-stable soil sections. In the settling (thaw-unstable) soil section, the soil above the pipe produces downward acting forces on the pipe. In the thaw-stable soil (“shoulder”) sections on either side of the settling section, the soil below the pipe provides upward acting bearing resistance to the downward motion of the pipe.

Figure 8.2-2 shows a representative buried pipe deformation analysis model corresponding to the thaw settlement configuration shown in Figure 8.2-1.

A rigorous analysis and design approach involves a nonlinear pipe-soil interaction analysis. The nonlinear stress-strain relationship of the pipe steel is considered. The model must account for the pipe axial and bending resistance, the longitudinal resistance of the soil caused by adhesion and friction, and the transverse soil resistance. The soil resistance is typically idealized as an

elastic-perfectly-plastic spring, as described in Appendix B. The distributed soil resistance is modeled as a Winkler foundation, i.e., the soil support is modeled as a series of discrete springs which provide a specified resistance per unit length of pipe. Large displacement (geometric stiffness, or cable action) effects can also be significant. General purpose 3D finite element programs (e.g., ANSYS or ABAQUS) and special purpose 2D pipeline deformation analysis programs (e.g., PIPLIN) can be used to analyze this scenario.

If the pipe and burial conditions are symmetric about the thaw region, symmetric boundary condition (i.e., zero rotation and zero longitudinal translation) can be imposed at the end of the model corresponding to the center of the settling section, in order to reduce the required size of the model. The model length should be long enough that the boundary condition specified at the remote end of the model has no influence on the analysis results, with zero axial strains at the ends of the model. For simplicity, the pipe is assumed to be initially straight with a uniform depth of soil cover. The pipe element lengths are varied to insure adequate mesh refinement in regions of high transverse soil forces and significant bending. Progressively longer element lengths can be used in sections of the model where there is no significant pipe or soil deformation. The soil springs are modeled as described in Appendix B.

For a typical ground displacement configuration, a range of analyses can be performed to investigate various model parameters, such as pipe thickness, pipe steel grade, span length, cover depth, soil strength, etc. For each analysis, a ground displacement profile is imposed at the base of the pipe-soil springs. The displacement profile is increased in small increments and the resulting pipe and soil deformation state is established at each increment. There are three main events that can occur as the ground displacement profile is progressively increased: (1) the pipe may reach a specified compressive strain limit, (2) the pipe may reach a specified tensile strain limit, and (3) the pipe-soil springs may yield over the entire length of the pipe section experiencing the ground displacements and the soil will continue to move past the pipe with no increased pipe deformations. The sequence of these events depends on numerous parameters including the length of the imposed displacement profile, depth of cover and soil strength, pipe temperature differential, pressure, etc.

It is only possible to develop simple design formulas for large differential ground displacements based on elastic stress analysis procedures for highly idealized conditions, such as uniform ground displacement along the axis of the pipe or arbitrarily-assumed deformation pattern of pipe in the soil.

8.3 Example: Pipeline Fault Crossing

A buried steel pipeline with a 48-inch diameter and a 0.469-inch wall operates at an internal pressure of 1000 psi and 135° F. The pipeline material is API 5L Grade X65. The pipe weighs 238 pounds per foot and contains oil at a specific gravity of 0.9, with a content weight of 678 pounds per foot. The pipe is buried at a depth of 3 feet, in soil with a density of 100 pounds per cubic foot and a friction angle of 35°. As shown in Figure 8.3-1, the middle of a long, straight section of the pipeline is subjected to a “guillotine” type vertical fault offset of 30 inches.

Table 8.3-1 shows the elasto-plastic soil resistance properties, computed using the procedures in Appendix B.

	Resistance (Kips/ft)	Elastic Stiffness (Kips/ft/in)	Slip Displacement (in)
Longitudinal	3.63	36.3	0.1
Uplift	1.99	2.21	0.9
Bearing	102.4	17.1	6.0

Table 8.3-1 Soil Resistance Properties for Example Problem

A 900-foot section of the pipeline is modeled using PIPLIN. The base of the pipe-soil springs are subjected to a 30-inch “guillotine” fault displacement profile, as shown in Figure 8.3-1. An inelastic model of the pipeline material and a non-linear model of the springs are used to calculate the pipeline response to fault displacement from the initial condition of zero fault movement, increasing in 1-inch increments up to the total fault movement of 30 inches.

The PIPLIN analysis results can be presented in many different ways. For this example, the along-the-pipe distribution of the pipe state at 15 inches and 30 inches of fault offset are compared using the spatial plots shown in Figures 8.3-2 through 8.3-4.

Figures 8.3-2(a) and 8.3-2(b) present the transverse and longitudinal (axial) pipe displacement profiles, with the axial displacement positive to the right in Figure 8.3-1.

Figures 8.3-2(c) and 8.3-2(d) present the pipe axial force and moment diagrams.

Figures 8.3-3(a) and 8.3-3(b) present the top (12 o’clock) and bottom (6 o’clock) fiber axial strain diagrams.

Figures 8.3-3(c) and 8.3-3(d) present the pipe curvature and rotation diagrams.

Figures 8.3-4(a) and 8.3-4(b) present the force (L-force) and displacement (L-displacement) in the longitudinal pipe-soil springs.

Figures 8.3-4(c) and 8.3-4(d) present the force (T-force) and displacement (T-displacement) in the transverse pipe-soil springs.

As shown in Figure 8.3-3(a) and (b), the maximum tension and minimum compression strains at 30 inches of fault offset are 0.28% and -1.26% , respectively. As shown in Figure 8.3-3(c), the maximum pipe curvature is 0.0039 ft^{-1} at 30 inches of fault offset. As shown in Figure 8.3-2(c), the at-rest compressive force in the pipe is -774 kips, due primarily to the line temperature of 135 F° . As the fault offset is increased, the axial force in the pipe becomes progressively less compressive and eventually becomes tensile with a force of about $+66$ kips at 30 inches of fault offset, due to “cable action.” Figure 8.3-4(a) illustrates how the force in the longitudinal pipe-soil springs “blows out” (i.e., the longitudinal slip force is fully mobilized) over progressively longer lengths with increasing fault offset. (See the flat portions of the L-force diagrams).

8.4 Figures

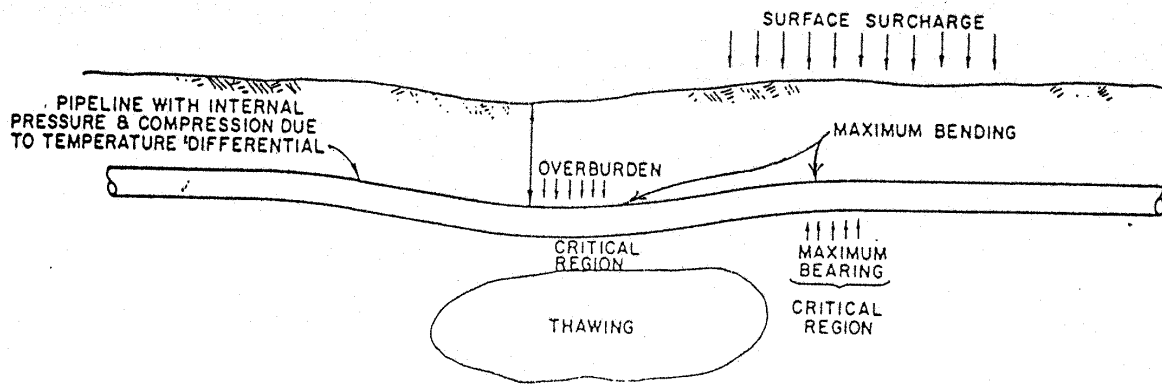

Figure 8.2-1 Pipeline Thaw Settlement Scenario

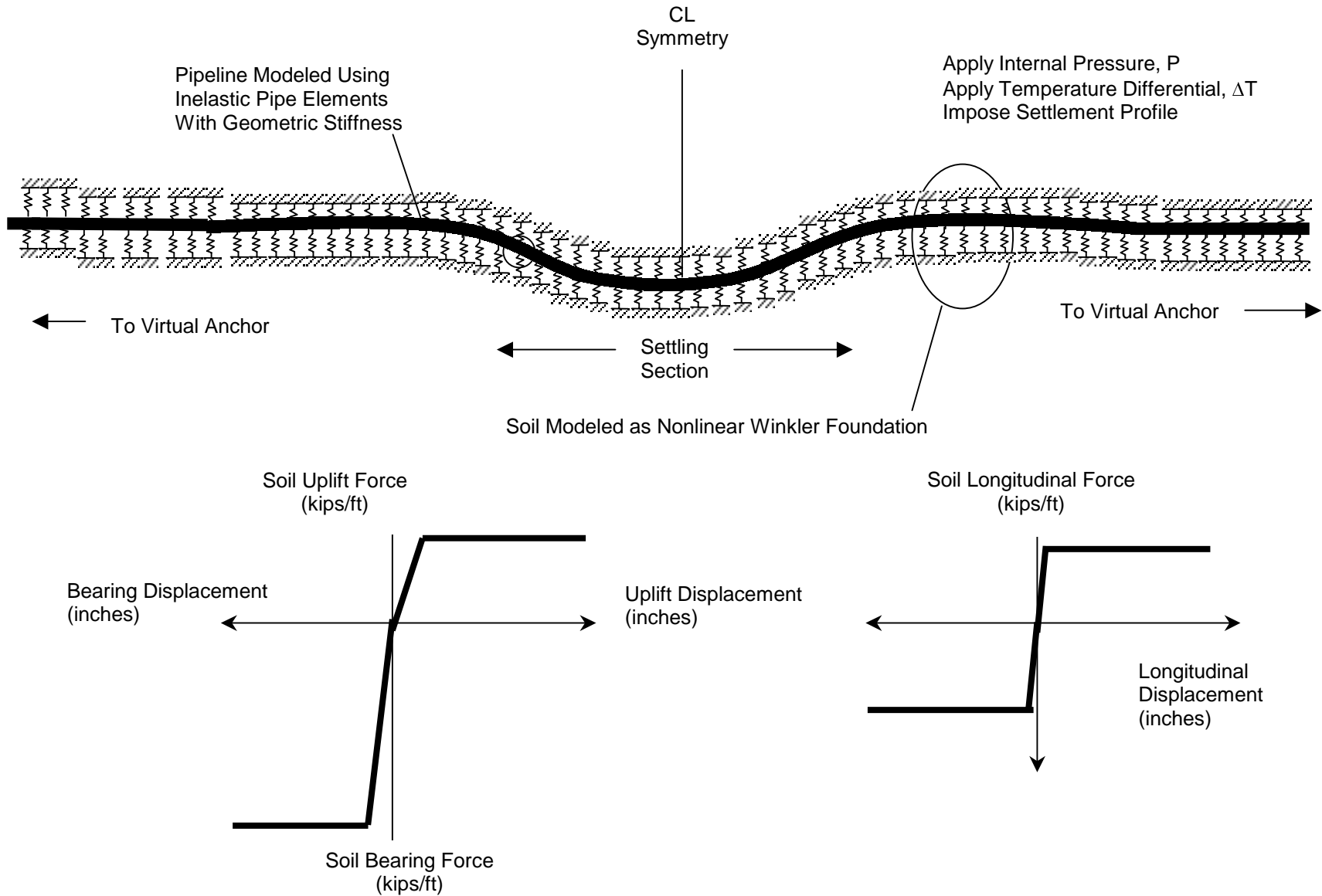

Figure 8.2-2 Finite Element Model of Pipeline Settlement

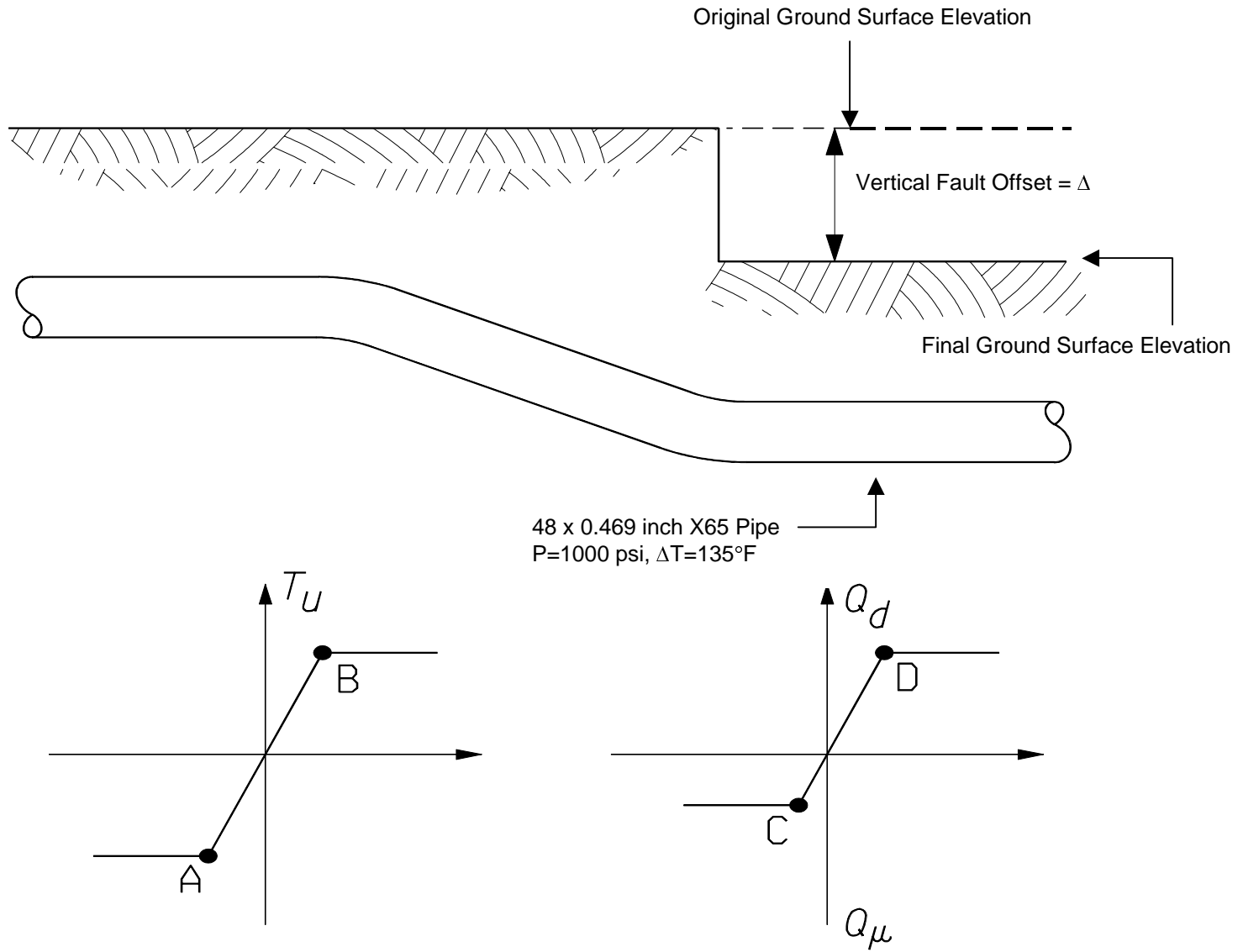

Figure 8.3-1 Buried Pipeline Subject to Vertical Fault Movement

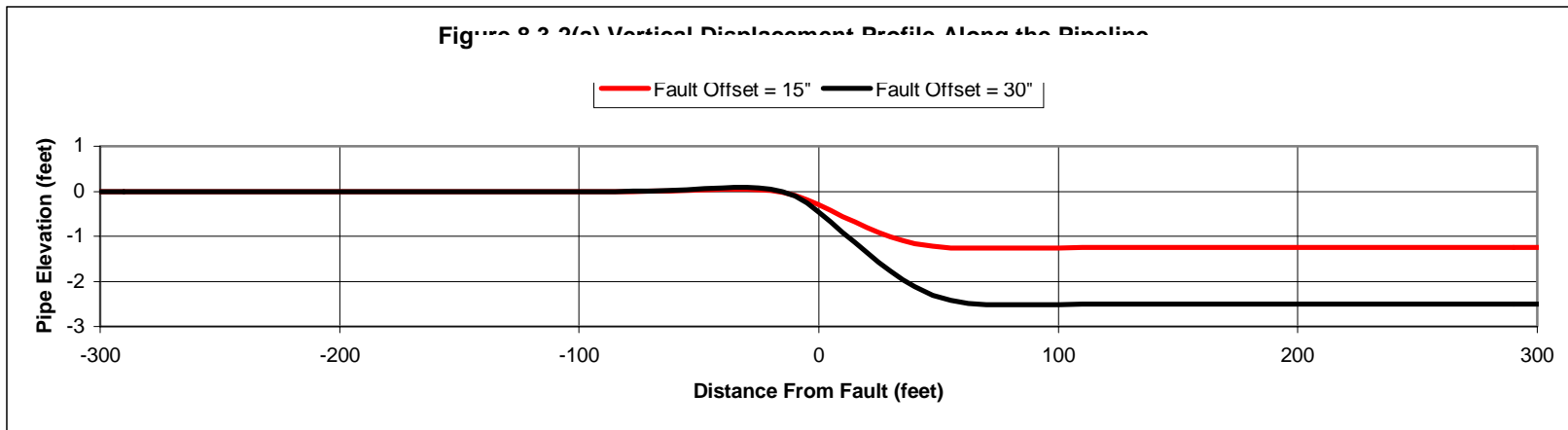

Figure 8.3-2(a) Vertical Displacement Profile Along the Pipeline

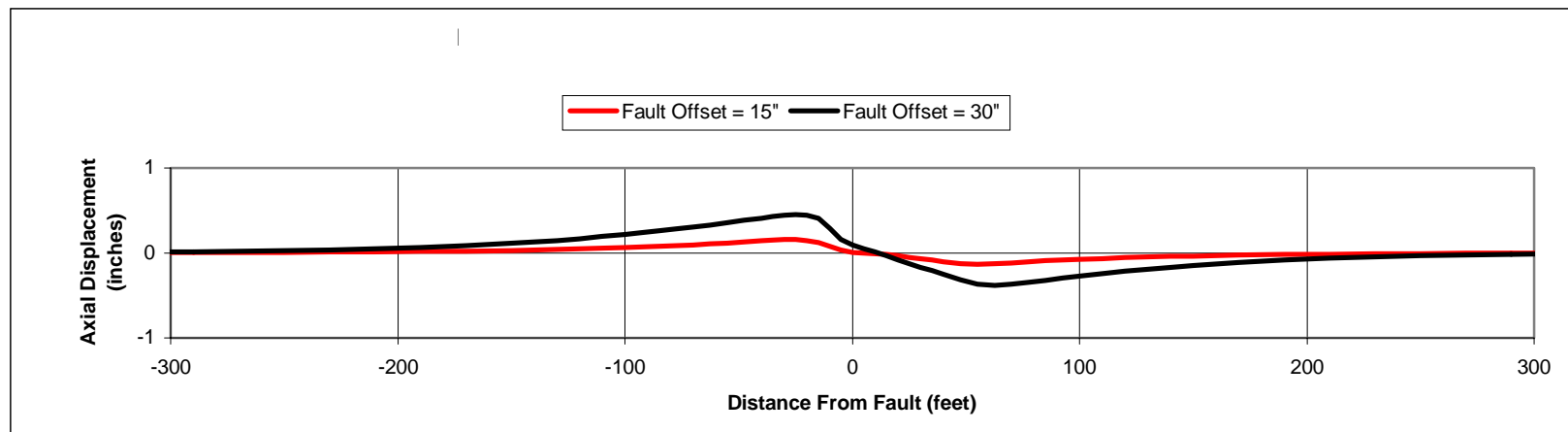

Figure 8.3-2(b) Axial Displacement Profile Along the Pipeline

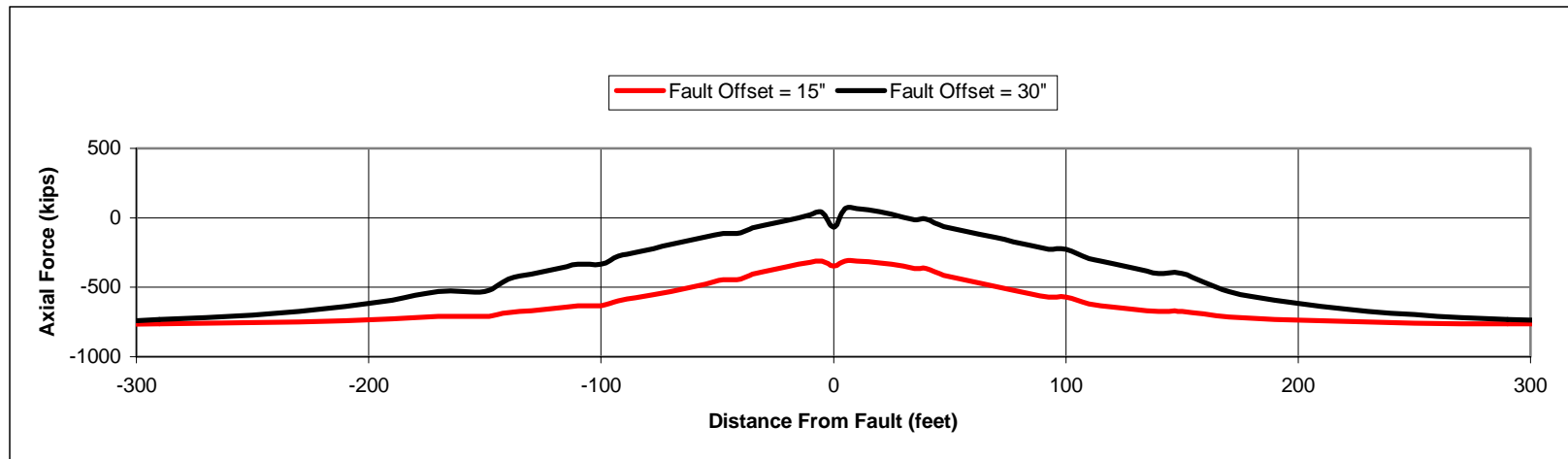

Figure 8.3-2(c) Axial Force Profile Along the Pipeline

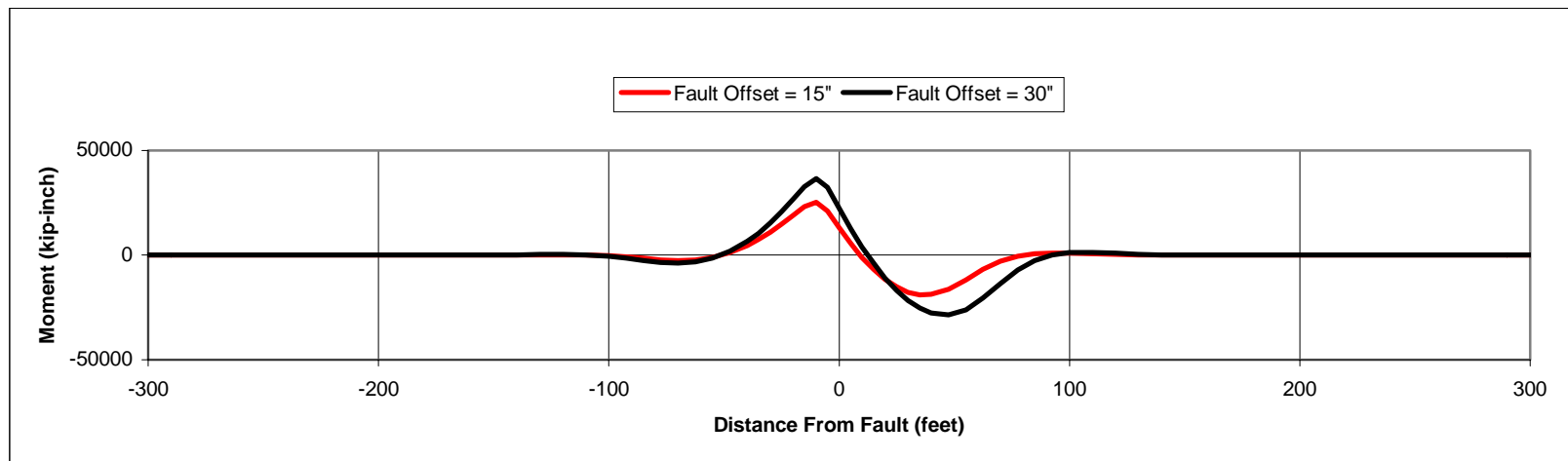

Figure 8.3-2(d) Bending Moment Diagram Along the Pipeline

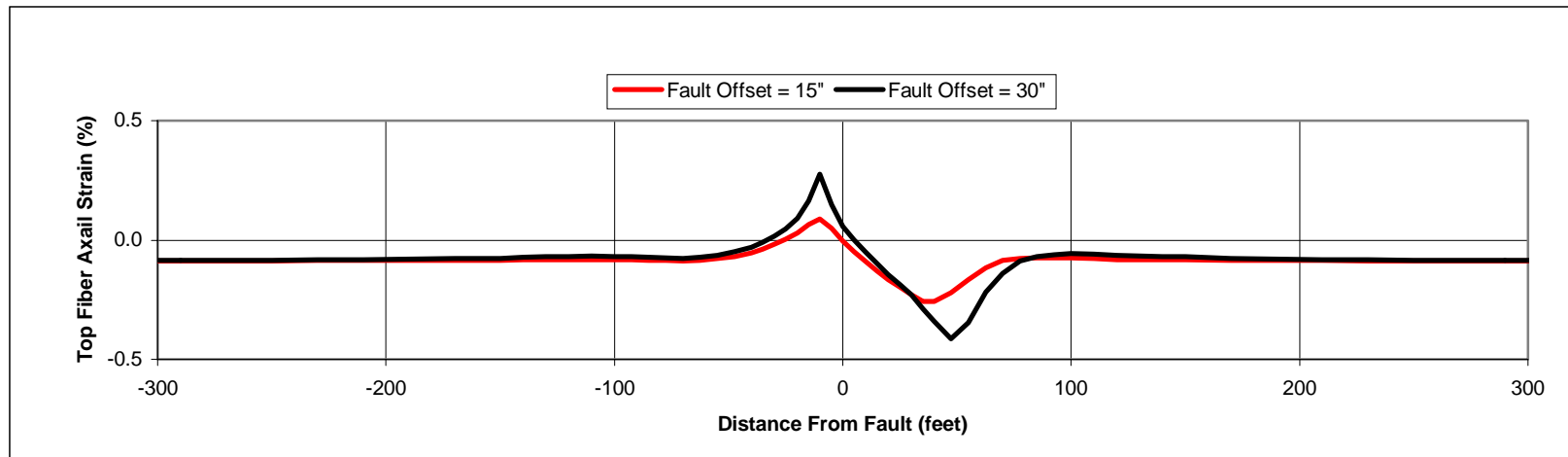

Figure 8.3-3(a) Top Fiber Axial Strain Diagram Along the Pipeline

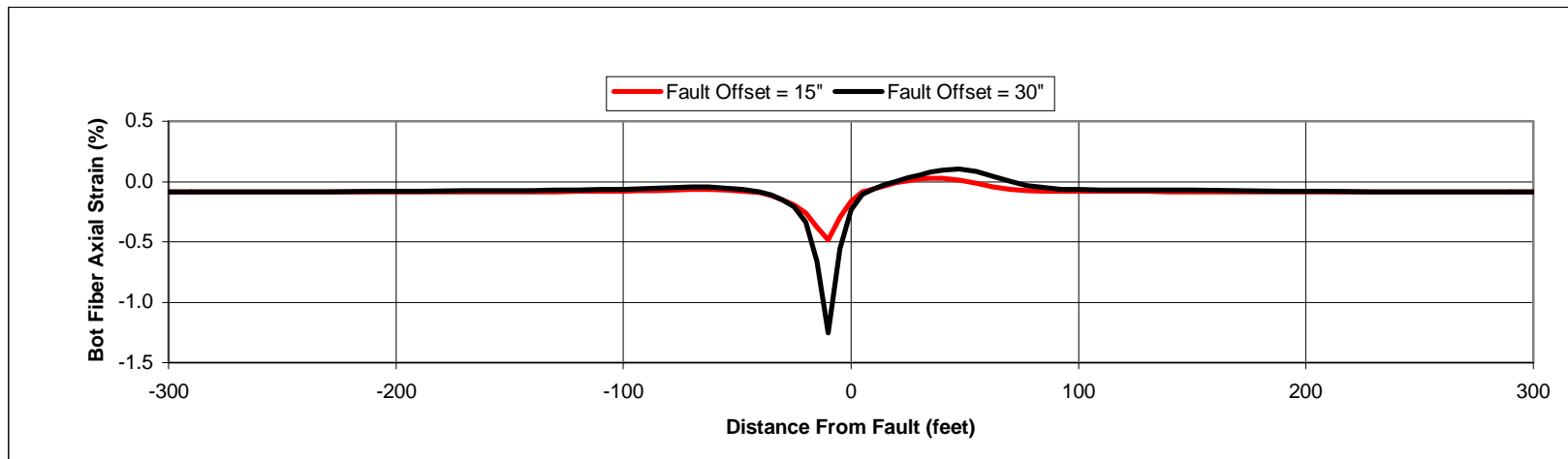

Figure 8.3-3(b) Bottom Fiber Axial Strain Diagram Along the Pipeline

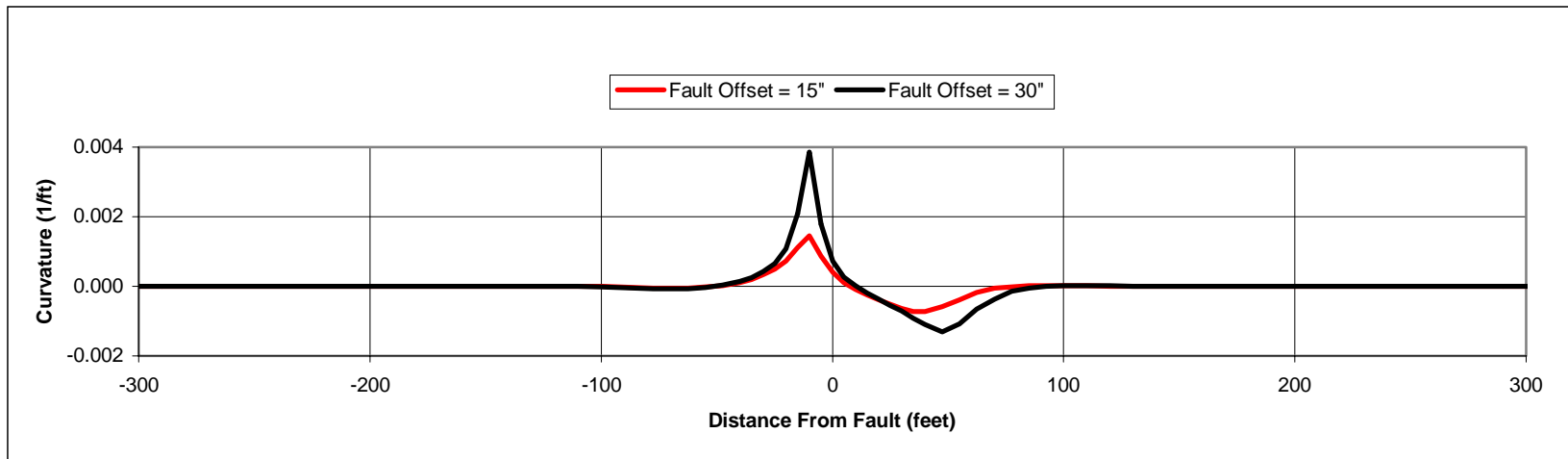

Figure 8.3-3(c) Pipe Curvature Diagram Along the Pipeline

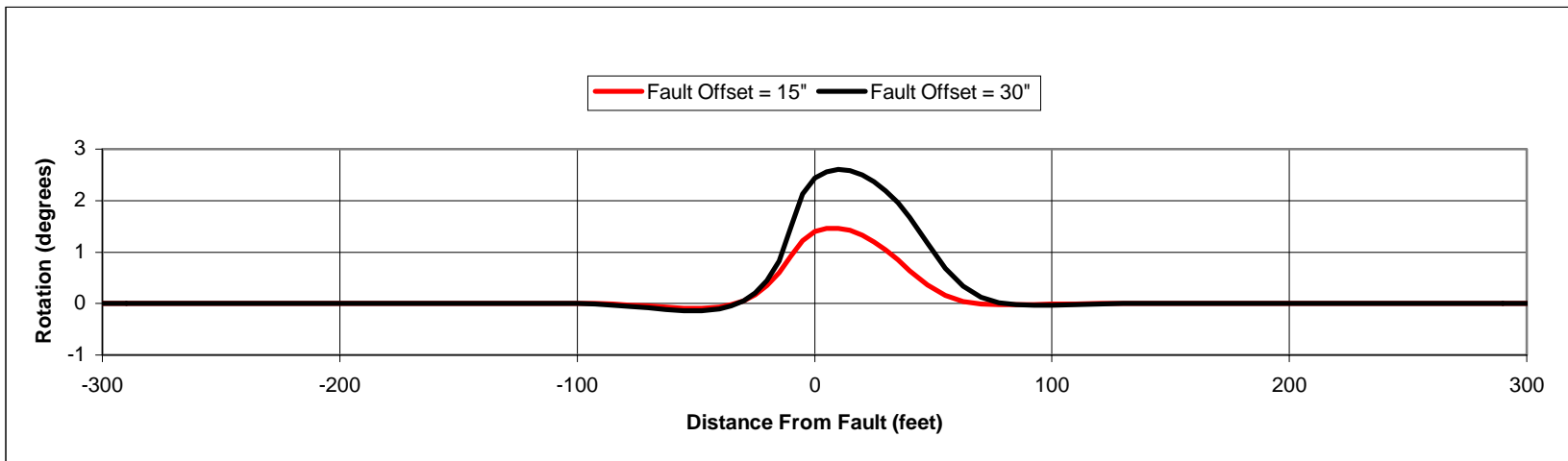

Figure 8.3-3(d) Pipe Rotation Diagram Along the Pipeline

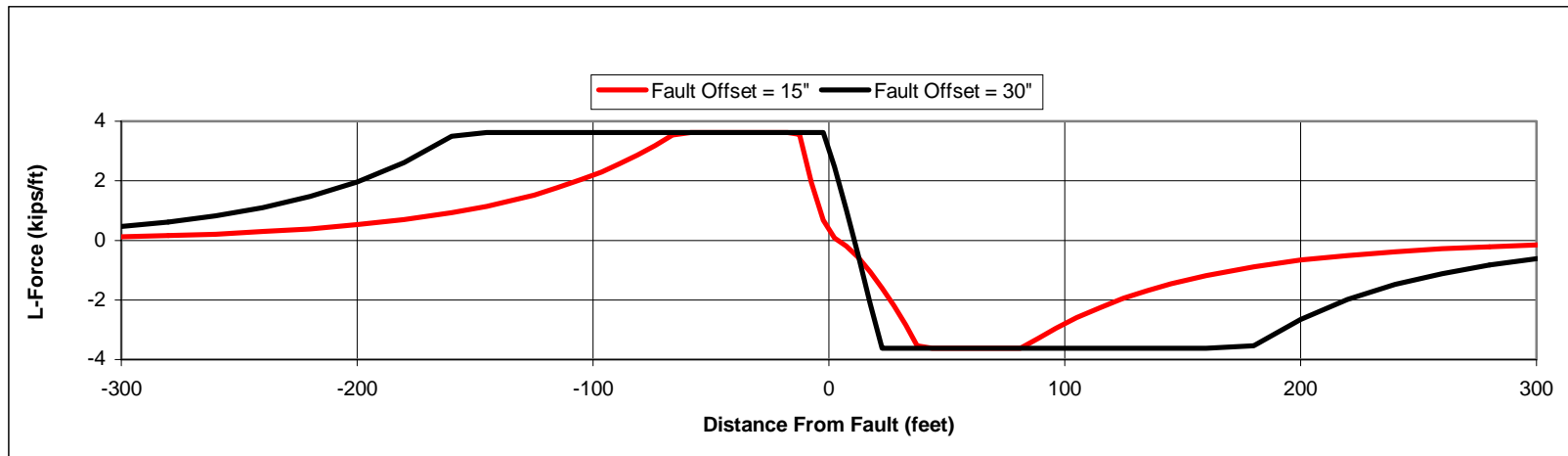

Figure 8.3-4(a) Force in Longitudinal Soil Springs Along the Pipeline

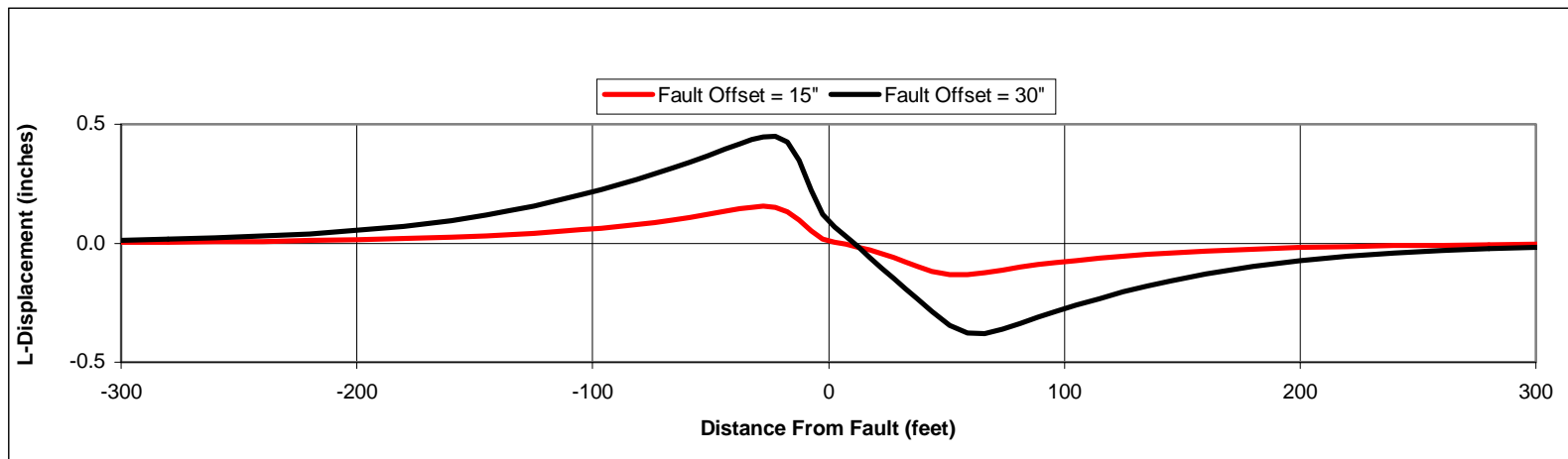

Figure 8.3-4(b) Displacement in Longitudinal Soil Springs Along the Pipeline

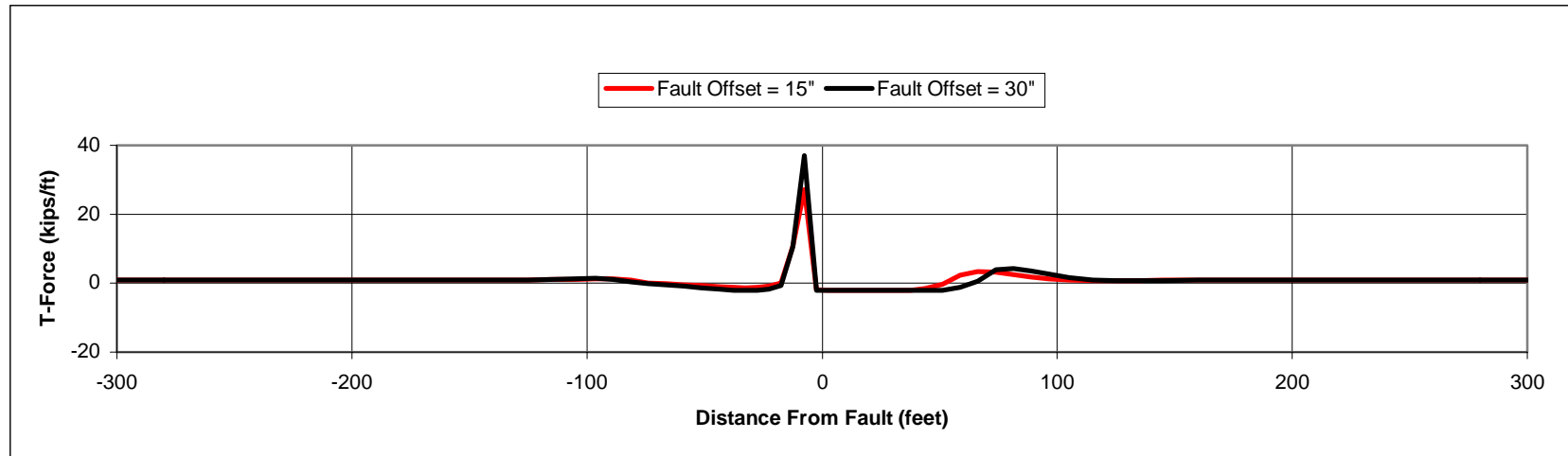

Figure 8.3-4(c) Force in Transverse Soil Springs Along the Pipeline

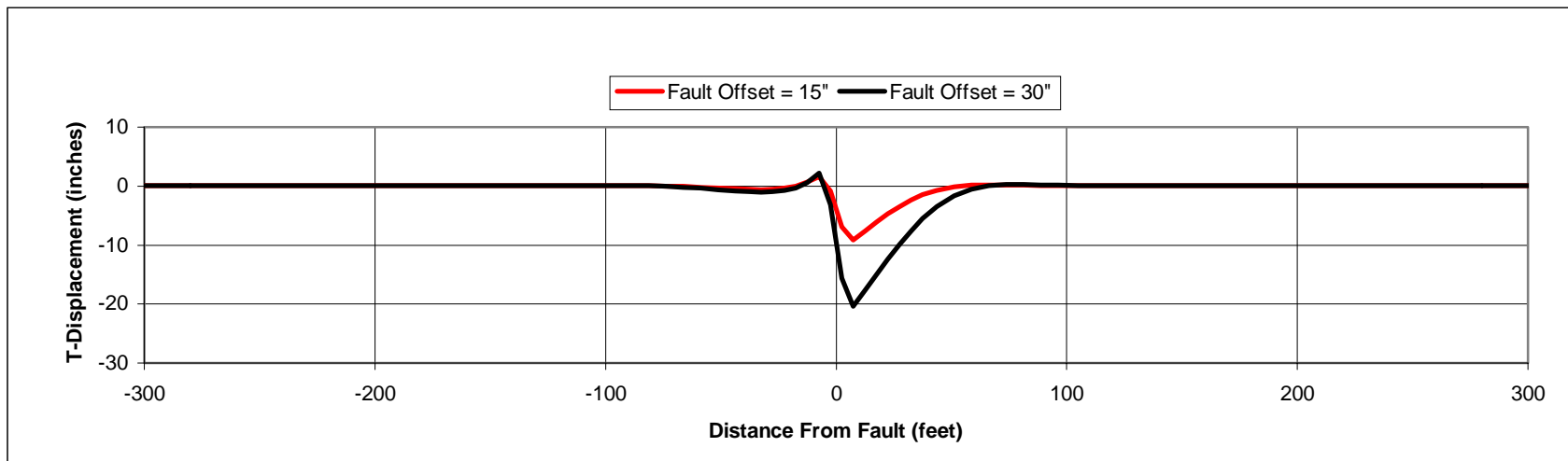

Figure 8.3-4(d) Displacement in Transverse Soil Springs Along the Pipeline

9.0 Movement at Pipe Bends

9.1 Pipe Movement

Movement of a buried pipeline can occur at the apex of sidebends, sagbends and overbends. This movement can be caused by either a net outward force generated by internal pressure, or expansion caused by temperature increases. The resulting forces are resisted by the pipe bending and axial stiffness and by the soil bearing and shear resistance, as illustrated in Figure 9.1-1. Soil resistance is a function of burial depth, backfill material type and level of compaction. This effect becomes an important consideration when transporting fluids at high temperatures, when the soil resistance is relatively weak, such as is in offshore buried pipelines [Kim], or with shallow covers. For instance, if the soil cover is insufficient at an overbend, the pipe can fail the overlying soil and deform past specified performance limits, or possibly rupture. Furthermore, the soil resistance can be degraded under large numbers of thermal cycles.

The amount of deformation in supporting soils at pipe bends and their resulting stresses and strains are a function of the soil-pipe interaction; and a non-linear analysis is required for proper assessment of these conditions. A rigorous analysis and design approach involves a nonlinear pipe-soil interaction analysis of representative buried field bend configurations, similar to the general procedures described in Section 8.0. The pipe-soil springs are modeled as described in Appendix B. Note that the most critical bend design case is typically at over bends, since the uplift resistance of the soil is typically substantially less than the horizontal and bearing resistance.

Given estimates of the pipe-soil springs, a series of parametric analyses can be carried out for a range of bend angles, soil types likely to be encountered along the alignment, and cover depths. A typical bend analysis consists of applying the design pressure together with the incremental application of the design temperature differential. The movement of the pipe at the apex of the bend and the maximum pipe stresses, strains and curvatures are monitored at each increment of the analysis.

Using the above parametric analyses, sets of bend design charts can be generated. A bend design chart is a plot of the bend angle on the horizontal axis and the cover depth on the vertical axis. This curve assumes that the bend uses the code minimum bend radius. For each of the different soil types considered along the pipeline alignment, a curve is developed that defines the cover depth required to limit the apex movement or pipe strain to the allowable value.

9.2 Evaluation

The goal of pipeline bend analysis is to insure that the pipeline does not experience either excessive apex movement or excessive pipe strains under design load conditions. To insure the safe and continuous operation of the pipeline, a set of limiting design criteria must be developed. These criteria are typically based on limiting the bend apex movement and pipe strain. Appendix A provides the suggested acceptance criteria.

9.3 Figure

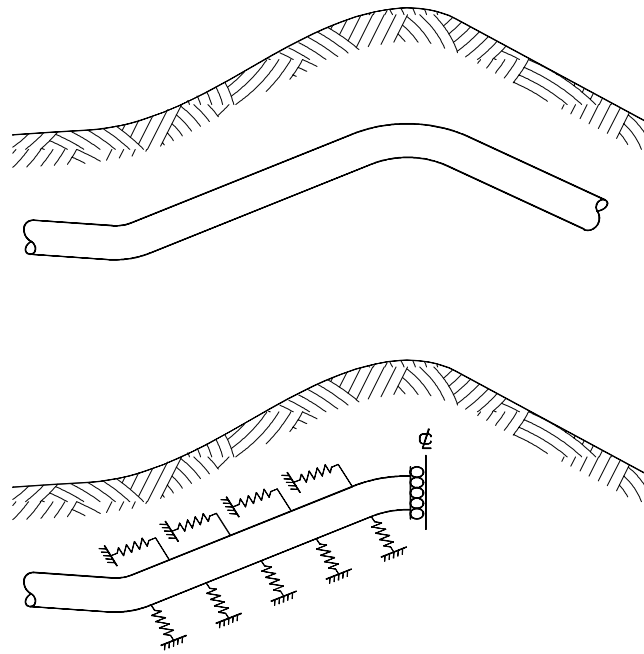

Figure 9.1-1 Model of Overbend

10.0 Mine Subsidence

Longwall mining is a unique process for extracting coal wherein virtually the entire seam is removed. A seam mined by this process may be between 5-feet and 15-feet thick, and typically lies 300 to 1,200 feet below ground. A rotary mill (the miner) traverses the mine face from floor to ceiling across the width of a “panel,” which may be between 500 and 1,500 feet in width and 5,000 to 15,000 feet in length. Coal is sent by conveyor to continuously mined tunnels adjacent to the panel and then out of the mine. Hydraulically actuated shields that advance the miner support the mine roof immediately behind him. When the excavated area or “gob” becomes large enough, the mine roof and strata fracture and cave in to fill the void of the gob behind the shields. Higher strata subsequently bend and sag. This bending and sagging propagates upward to form a subsidence basin at the ground surface. The subsidence basin covers a larger area than the gob, but is not as deep as the original mined height of the seam due to rubblization in the gob.

While vertical subsidence is most dramatic at the center of the subsidence basin, tilting and shear at the sides of the basin are of greatest concern for surface structures. For buried linear structures such as pipelines, the concern is more subtle. Horizontal movement directed toward the center of subsidence occurs as a result of the bending rotation of overburdened strata. This gives rise to tensile soil strains in the outer portions of the subsidence basin and compressive strains in the inner portions of the basin. A buried pipeline will thus be exposed to tensile or compressive strains to the extent that it is aligned with horizontal deformation and strain components. These strains may exceed 1.5% strain, which, if compressive, is enough to buckle high-D/t pipe or, if tensile, is enough to separate a girth weld of substandard quality. Soil stresses also damage some types of corrosion coating.

When evaluating a mine subsidence problem as an in-service lowering, it can be concluded that the stresses due to vertical soil movement are very low and are of little concern. Such an approach overlooks the more serious threat to pipelines from horizontal soil strains. Analytical computer programs based on the influence coefficient method [Peng] are available for accurately predicting the dynamic and final subsidence characteristics, including the horizontal soil strain. Applying these methods is beyond the scope of this document. These methods can be used to determine what portions of a pipeline may experience excessive strain levels. Analysis of pipeline response to ground displacements from mine subsidence can be performed using finite element techniques as described in Section 9.0. Mitigation usually involves excavating portions of the pipeline to uncouple them from the soil, then monitoring strain levels in the exposed pipeline, restoring the line to a state of low residual strain, and backfilling it. This can often be accomplished while maintaining continuous service in the line.

The effect of mine subsidence can be evaluated using estimates of the ground displacement profiles (e.g., Peng) together with the pipe-soil interaction models discussed in Section 8.0, considering both buried and temporarily exposed sections of the pipeline.

11.0 Earthquake

Potential earthquake hazards to buried pipelines include transitory strains caused by differential ground displacement arising from ground shaking and permanent ground displacement (PGD) from surface faulting, lateral spread displacement, triggered landslide displacement, and settlement from compaction or liquefaction. Wave propagation strains for the pipelines covered by these guidelines can be calculated as covered in this section. The effects of permanent ground displacement produced by an earthquake are best evaluated using finite element analysis techniques described in Section 9.0. Hand calculation of the response of buried pipelines to PGD is applicable for simple, idealized conditions—one of which is covered in this section. Hand calculations are also useful in familiarizing one with the general characteristics of buried pipeline response to PGD.

11.1 Seismic Wave Propagation

Wave propagation provisions are presented in terms of longitudinal axial strain, that is, strain parallel to the pipe axis induced by ground strain. Flexural strains due to ground curvature are neglected since they are small for typical pipeline diameters.

The axial strain, ε_a , induced in a buried pipe by wave propagation can be approximated using the following equation:

$$\varepsilon_a = \frac{V_g}{\alpha C_s} \quad (11-1)$$

where:

V_g = peak ground velocity generated by ground shaking

C_s = apparent propagation velocity for seismic waves (conservatively assumed to be 2 kilometers per second)

α = 2.0 for C_s associated with shear waves, 1.0 otherwise

The axial strains produced by Equation (11-1) can be assumed to be transferred to the pipeline but need not be taken as larger than the axial strain induced by friction at the soil pipe interface:

$$\varepsilon_a \leq \frac{T_u \lambda}{4AE} \quad (11-2)$$

where:

T_u = peak friction force per unit length at soil-pipe interface (see Appendix A)

λ = apparent wavelength of seismic waves at ground surface, sometimes assumed to be 1.0 kilometers without further information

A = pipe cross-sectional area

E = steel modulus of elasticity

If only peak ground acceleration values for the site are available, Table 11.1-1 may be used to determine peak ground velocity.

Moment Magnitude, M_W	Ratio of Peak Ground Velocity (cm/sec) to Peak Ground Acceleration (g) Source-to-Site Distance (km)		
	0-20	20-50	50-100
<i>Rock*</i>			
6.5	66	76	86
7.5	97	109	97
8.5	127	140	152
<i>Stiff Soil*</i>			
6.5	94	102	109
7.5	140	127	155
8.5	180	188	193
<i>Soft Soil*</i>			
6.5	140	132	142
7.5	208	165	201
8.5	269	244	251

* The sediment types represent the following shear wave velocity ranges within the sediment layer: rock \geq 750 meters per second, stiff soil is 200 meters per second – 750 meters per second, and soft soil $<$ 200 meters per second. The relationship between the peak ground velocity and peak ground acceleration is less certain in soft soils.

Table 11.1-1 Peak Ground Velocity

Determination of the types of seismic waves to associate with estimates of peak ground velocity requires a site-specific assessment by a seismologist. The peak ground velocity, V_g in Equation (11-1), is usually associated with shear waves, particularly for locations close to the earthquake source. Several studies of basin response effects and well-instrumented earthquakes conclude a dominance of surface waves at some locations in past earthquakes, mostly at locations greater than 20 km from the earthquake source. These past investigations highlight the need to consider surface waves, especially for sites within sedimentary basins. Given that the potential for dominant participation by surface waves can not always be discounted, a reasonable approach to assessing the importance of wave propagation effects on a buried pipeline is to assume that ground strains will be generated by surface waves. This assumption will always lead to a larger ground strain than might be expected from shear waves.

11.2 Permanent Ground Displacement

By its nature, liquefaction induced permanent ground displacement (PGD) often causes flexural strains in buried pipe, and almost always induces axial strains. Both effects—axial and bending—need to be considered in the structural analysis of the buried pipeline model.

The amount of strain in a buried pipe caused by liquefaction induced PGD is a function of the amount of ground movement, the spatial distribution of the ground movement, the spatial extent

of the PGD zone, and the orientation of the pipe axis with respect to the direction of PGD movement. For example, if the direction of ground movement is nominally parallel to the pipe axis, or longitudinal PGD, then pipe axial stresses predominate. If the length of the PGD zone is small to moderate, then the induced axial strains are solely a function of the length of the PGD zone parallel to the pipe axis (parallel to the direction of PGD ground movement) as illustrated in Figure 11.2-1.

In contrast, if the length of the PGD zone is quite large, then the induced axial strains are solely a function of the amount of ground movement Δ that involves stretching the pipe within L_c on each side of the PGD zone head, which accommodates the ground movement Δ as illustrated in Figure 11.2-2. Similarly, compression within a distance L_c at the toe of the zone accommodates the zone movement Δ . Note that in both examples of pure longitudinal PGD, using upper-bound values for L or Δ is conservative.

If the direction of ground movement is nominally perpendicular to the pipe axis (transverse PGD), then both axial and flexural strains are induced as illustrated in Figure 11.2-3. In part, the pipe acts as a fixed-fixed beam spacing between the margins of the PGD zone (inducing flexural stresses and strains). The pipe also acts in part like a flexible cable, accommodating the imposed ground displacement by stretching. In relation to cable-like behavior, axial tension in the “cable” at the margin of the zone is resisted by friction forces at the soil-pipe interface well beyond the PGD itself.

For transverse PGD, the spatial distribution of ground movement is significant. For example, if the amount of PGD movement is uniform across the width W of the zone, then strains induced at the margins (fault-crossing like behavior) tend to be larger than in the case where ground movements are small at the margin and increase gradually towards the center (distribution).

Unlike longitudinal PGD, using an upper-bound value for the spatial extent of the zone W for distributed transverse PGD is not necessarily conservative.

11.3 Example

Evaluate a rough-surfaced steel pipe with a 24-inch diameter and a 0.5-inch wall, buried in stiff soil with 3 feet of cover. The backfill consists of sand with $\phi = 33^\circ$ and effective unit weight of 115 pounds per cubic foot. The estimated peak ground acceleration at the site is 0.74g due to a large magnitude earthquake ($M_W = 7$ to $\sim 8^+$) and a relatively short source to site distance ($R < 20$ km). To obtain an upper estimate of the potential strains that might be induced in the pipe from wave propagation, the motions at the site are assumed to be attributed to Rayleigh waves with $C_s = 500$ m/s. From Table 11.1-1 for our stiff soil site:

$$PGV / PGA \sim 180$$

or:

$$V_s = PGV = 180 \text{ cm/sec.g (0.74g)} = 133 \text{ cm/sec}$$

The induced axial strain then becomes:

$$\varepsilon_a = \frac{1.33}{2000} = 0.00067$$

but ϵ_a need not be taken larger than:

$$\epsilon_a < T_u \lambda / (4 AE)$$

For our case, with cohesionless backfill, the peak force per unit length of the soil-pipe interface (from Appendix B) is:

$$T_u = \frac{\pi}{2} DH \bar{\gamma} (1 + K_o) \tan \delta$$

where:

$$D = 24\text{-inch} = 2 \text{ feet}$$

$$H = \text{cover} + D/2 = 4 \text{ feet}$$

$$\bar{\gamma} = 115 \text{ pounds per cubic foot}$$

$$K_o = 1.0$$

$$\delta = 0.8 (33^\circ) = 26.4^\circ$$

$$\tan \delta = 0.496$$

$$T_u = \frac{\pi}{2} 2(4)(115)(1+1) \tan(26.4^\circ) = 1435 \frac{\text{lb}}{\text{ft}}$$

With $T_U = 1435 \text{ lb/ft}$, $\lambda = 1.0 \text{ km} = 3278 \text{ ft}$, $E = 29 \cdot 10^6 \text{ psi}$, and $A = \pi (24'')(0.5'') = 37.6 \text{ in}^2$, the calculated axial strain (0.00267) need not be larger than:

$$\epsilon_a = 0.001$$

The PGV used in this example is an upperbound value for past earthquakes. As such, this example demonstrates that wave propagation ground strains will rarely exceed 0.3%. However, the actual strain that can be induced in the pipeline through soil friction is typically much smaller (0.1% in this example).

A rigorous analysis and design approach for evaluating permanent ground displacement (PGD) for all but the simplest cases involves a nonlinear pipe-soil interaction analysis using the procedures described in Section 8.0.

11.4 Figures

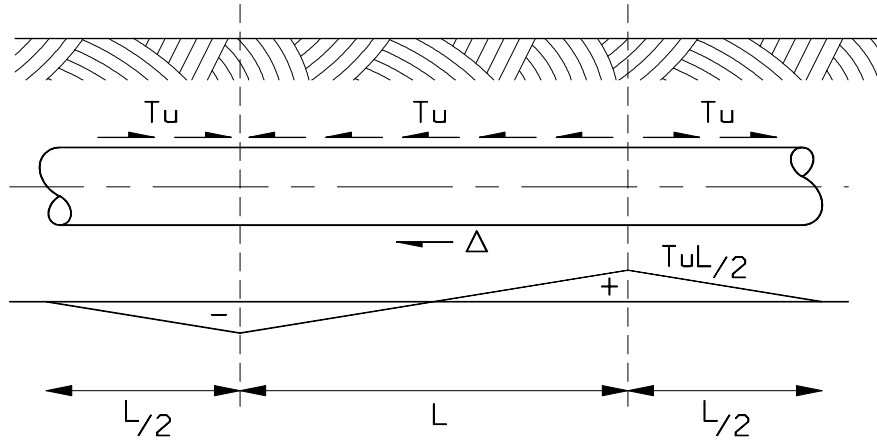

Figure 11.2-1 Direction of Ground Movement Δ and Zones of Pipe Axial Tension and Compression for Longitudinal PGD where L is Small to Moderate

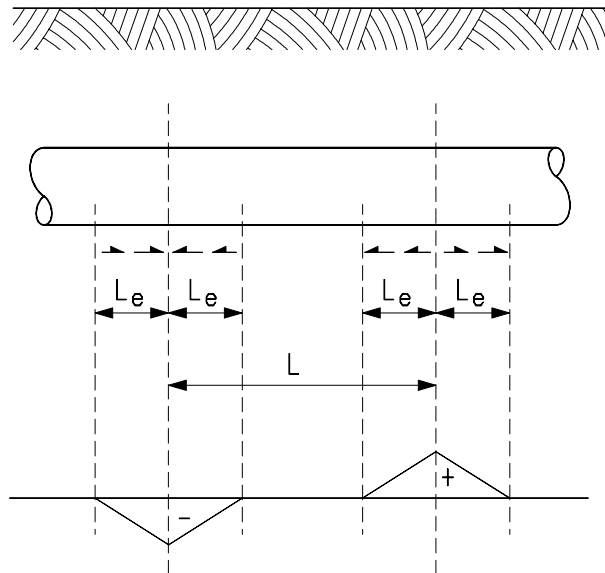

Figure 11.2-2 Direction of Ground Movement Δ and Zones of Pipe Axial Tension and Compression for Longitudinal PGD where the Length of the PGD Zone is Large

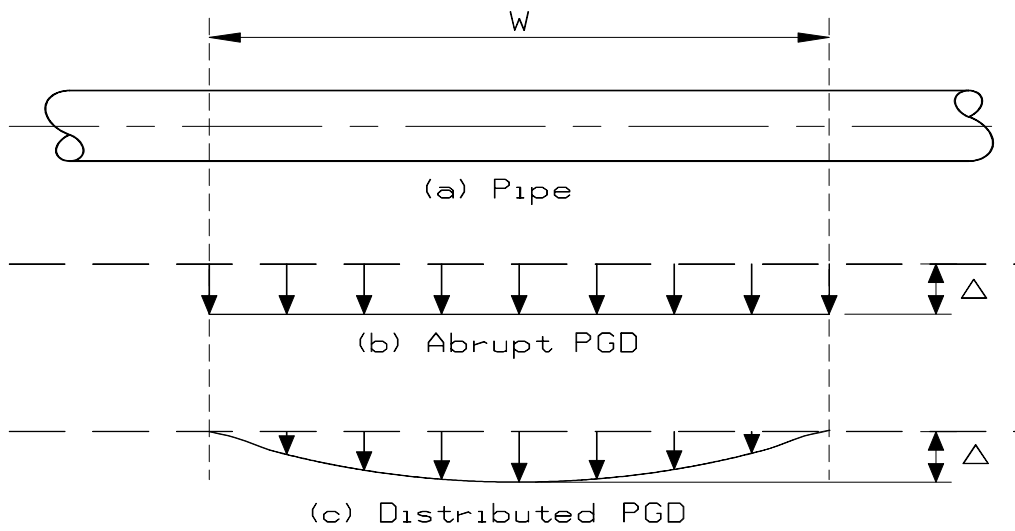

Figure 11.2-3 Transverse PGD With Spatial Extend W and Amount of Movement Δ

12.0 Effects of Nearby Blasting

12.1 Applied Stress

Blasting in the vicinity of a pipeline typically occurs as a result of mining or nearby construction activities. While normally an issue for existing pipelines, blasting effects may be considered for new designs if future land use plans are known to include the construction of adjacent pipeline or development of mined areas. Pipeline stresses generated by nearby blasting can vary greatly based on local variation in site conditions, the degree to which the blast is confined, delays between multi-shot blasts, and the type of explosive used. Expressions for peak radial ground velocity and peak pipe stress are based on characterizing the blasting configuration as either point or parallel line sources. The following expressions have been validated through controlled blasting experiments in soil [Esparza, 1981]. It is important to note that while Equation (12-1) is non-dimensional, i.e., any consistent set of units can be used, Equation (12-2) must be used with the units indicated.

Peak Radial Ground Velocity:

$$U = K_1 C_p^2 \sqrt{\frac{\rho}{p_0}} \left(\frac{W_{eff}}{\rho c^2 R_s^{K_3}} \right)^{K_3} \quad (12-1)$$

Peak Pipe Stress (Longitudinal or Circumferential):

$$\sigma = 4.44 E \left(\frac{K_4 W_s}{\sqrt{E t} (R_s)^{K_5}} \right)^{K_6} \quad (12-2)$$

where:

- E = pipe modulus of elasticity, psi
- t = pipe wall thickness, inches
- U = peak radial ground velocity, feet per second
- ρ = mass density of soil, lb-sec²/ft⁴
- p_0 = atmospheric pressure, psf
- C_p = seismic P-wave velocity in soil, feet per second
- K_i = empirical coefficients, see Table 12.1
- R_s = standoff distance, ft (must be greater than two pipe diameters; see Figure 12.1-1)
- W_{eff} = effective explosive energy release = $1.52(10)^6 W_s$
- W_s = scaled explosive weight (pounds) = $n W_{act}$
- W_{act} = actual weight of explosive charge, pounds

n = factor to normalize explosive to ANFO (94/6); energy released per unit weight of explosive / 1.52×10^6 ft-lb/lb (see Table 12.2 for common explosives)

The standard error on peak ground velocity and peak pipe stress is estimated to be 34%. Conservative estimations of the pipe stress or a ground velocity necessary in producing certain levels of pipe stress can be introduced by assuming a normal distribution and applying the estimate of standard error. The amount of conservatism to be incorporated should be determined by the pipeline owner, based on factors including the consequences of exceeding specified allowable stresses, the condition of the pipeline, monitoring activities during blasting, and control over blasting operations.

Ground velocity and pipe stress relationships for rock blasting are not supported as well by experimental data as are similar relationships for soil blasting. For free-face blasting that might exist in an open quarry, evidence suggests that stress from Equation (12-2) is likely to represent a 95% bound on the peak pipeline stress (i.e., 95% of the data points are below this stress). For confined rock blasting that might occur when blasting an adjacent trench, doubling the stress computed using Equation (12-2) has been shown to provide the same 95% bound for data from a very limited number of field tests [Esparza, 1991].

K_i	Point Source Figure 11-1(a)	Parallel Line Source Figure 11-1(b)
K_1	0.00489	0.00465
K_2	3.0	2.0
K_3	0.790	0.734
K_4	1.0	1.4
K_5	2.5	1.5
K_6	0.77	0.77

Table 12.1 Empirical Coefficients for Estimating Velocity and Stress

Explosive	Average Energy Density (ft-lb/lb)	Normalizing Factor n
ANFO (94/6)	1.52×10^6	1.0
AN Low Density Dynamite	1.50×10^6	0.99
Comp B (60/40)	1.70×10^6	1.12
Comp C-4	1.70×10^6	1.12
HBX-1	1.30×10^6	0.86
NG Dynamite (40%)	1.70×10^6	1.12
Pentolite (50/50)	1.68×10^6	1.11
RDX	1.76×10^6	1.16
TNT	1.49×10^6	0.98

Table 12.2 Normalization Factors for Common Types of Explosives

12.2 Evaluation

Peak pipe stress from Equation 911-2) should be combined with the longitudinal and circumferential stresses from other applicable load conditions. The values using Equation (12-2) are mean values. If more conservative estimates of blasting stresses are desired, the values using Equation (12-2) should be increased by the following factor:

$$\sigma_{be} = \sigma(k + 0.34\Phi(x)^{-1}) \quad (12-3)$$

where:

k = mean correction factor, 1 for soil, -1.65 for rock

σ = stress due to blast (See Section 12.2)

σ_{be} = corrected stress due to blasting accounting for additional conservatism over mean

$\Phi(x)^{-1}$ = inverse of the standard normal probability function

12.3 Example

A natural gas pipeline operator discovers an abandoned explosives magazine 150 yards from his 30-inch pipeline. The X52 pipeline operates at 900 psi and has a wall thickness of 0.406 inches. Inspections of the magazine indicate 500 pounds of TNT. It is recommended that the explosive be detonated in place because of its deteriorated condition. Estimate the stresses in the pipeline and determine what, if any, measures are necessary to maintain the pipeline in a safe state during the detonation. For assessing pipeline response, it is desired to have less than a 2% chance that the pipe will experience damage from the blasting.

The explosives can be considered a point charge with an effective weight of $0.98(500) = 490$ pounds (0.98 factor from Table 12.2).

The hoop stress in the pipe from operating pressure is taken as: $\frac{pD}{2t} = \frac{900(30)}{2(0.406)} = 33,251$ psi

The average peak stress in the pipe due to blasting is estimated using Equation 12-2:

$$\sigma = 4.44E \left(\frac{K_4 W_s}{\sqrt{Et} R_s^{K_5}} \right)^{K_6} = 4.44 (29(10)^6) \left(\frac{490}{\sqrt{29(10)^6 0.406 (450)^{2.5}}} \right)^{0.77}$$

$$\sigma = 225 \text{ psi}$$

From a table of standard normal probability, it is determined that the inverse of the standard normal probability function corresponding to 98% is 2.06. This value, representing the number of standard deviations above the mean, corresponds to a 2% probability of exceedance.

$$\sigma_{be} = 225[1 + 0.34(2.06)] = 382 \text{ psi}$$

The signs of the blast-induced stress can be positive or negative. The maximum stress in the pipeline can be estimated as the algebraic sum of the blast-related stress, σ , and the hoop stress from internal pressure, σ_h .

$$\sigma_h + \sigma_{be} = 33,125 + 382 = 33,507 \text{ psi}$$

12.4 Figure

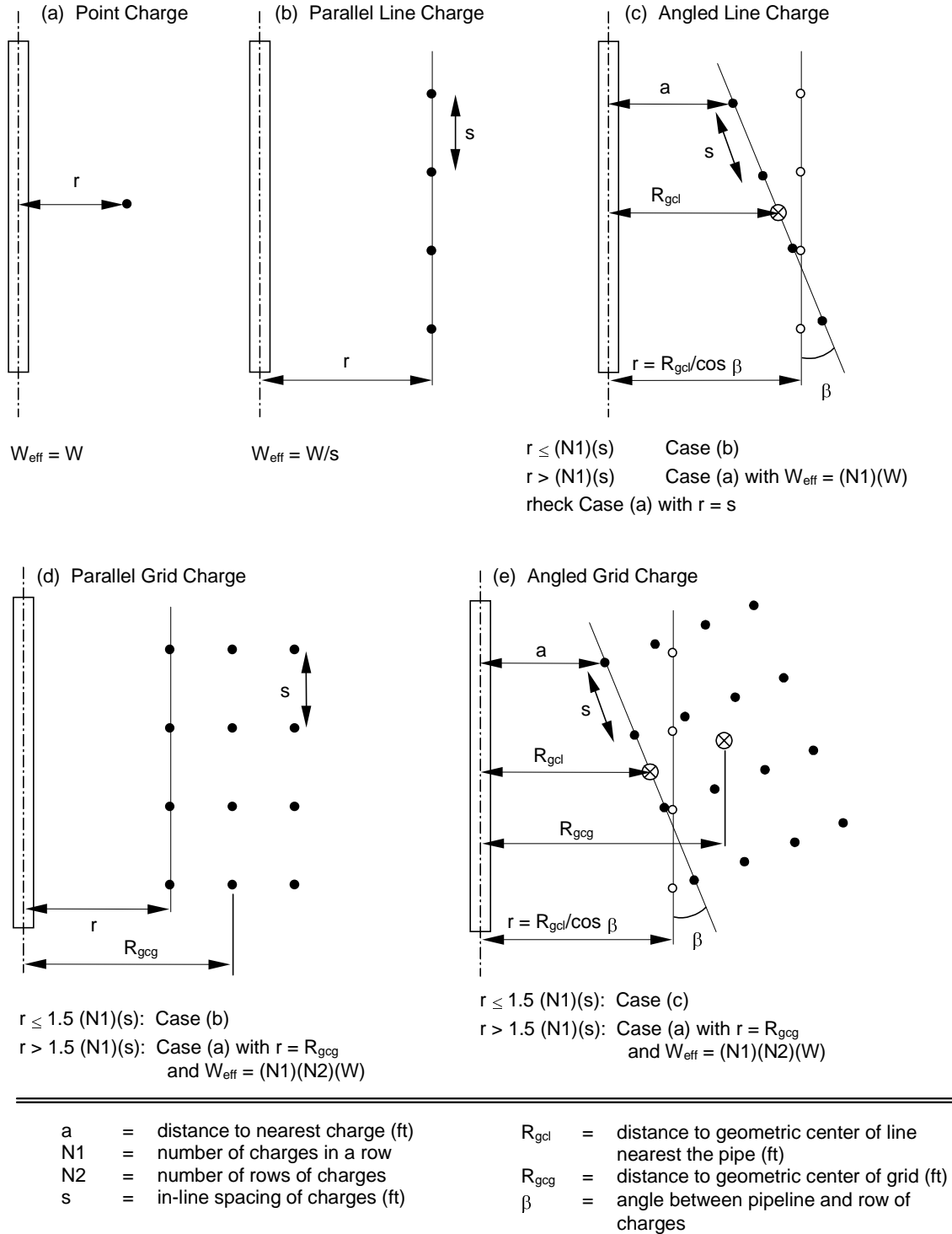

Figure 12.1-1 Determination of Charge Weight and Distance for Common Patterns

13.0 Fluid Transients

13.1 Applied Loads

Rapid changes in the flow rates of liquid or two-phase piping systems (liquid-gas or liquid-vapor) can cause pressure transients, which in turn generate pressure pulses and transient forces in the piping system. The magnitude of these pressure pulses and force transients is often difficult to predict and quantify. Only the simplest cases can be calculated by hand, as is the case for a rapid valve closure in a liquid system. A valve closure is considered rapid if its closing time is:

$$t_c = \frac{2L_v}{c_L} \quad (13-1)$$

where:

- t_c = valve closing time, sec
- L_v = distance from the valve to an upstream pressure source such as a tank, inches
- c_L = sonic velocity in the liquid, inches per second

$$c_L = \sqrt{\frac{K/\rho}{1 + (K/E) \cdot (D/t)}}$$

- K = bulk modulus of fluid
- P = fluid density
- E = pipe modulus of elasticity
- D = pipe mean diameter
- t = pipe wall thickness

The pressure rise is:

$$dP = \frac{\rho_f a (\Delta v)}{g} \quad (13-2)$$

where:

- dP = pressure rise in a liquid pipeline due to rapid valve closure, psi
- ρ_f = liquid density, pounds per cubic inch
- Δv = change in liquid velocity from initial flow rate to zero (closed valve), inches per second
- g = gravitational coefficient (386 in/sec²)

This pressure rise first occurs at the closed valve, propagates upstream and reflects at the pressure source. For flow transients more complex than a rapid valve closure and for two-phase

flow conditions, a detailed computational fluid dynamics analysis may be required to predict the pressure and force transient time history in the piping system.

13.2 Evaluation

13.2.1 Pressure Transient

The pressure rise due to a flow transient and its effects are the same in pipes above and below ground. The pressure rise could be large enough to burst the pipe.

13.2.2 Thrust Loads

As a result of waterhammer, an unbalanced impulsive force, called a “thrust” load, is applied successively along each straight segment of buried pipe. This causes a pressure imbalance of dP between consecutive bends. The unbalanced impulsive load is:

$$F = dP(DMF)A_f \quad (13-4)$$

where:

DMF = dynamic magnification factor of impulsive load, maximum 2.0

dP = pressure rise from waterhammer, psi

A_f = pipe flow cross sectional area, square inches

The thrust loads from pressure transients can cause large displacements in above-ground piping systems, which can bend or rupture the pipe, or fail pipe supports at welds or concrete anchor bolts. In contrast, buried welded steel pipes are continuously supported and therefore will not typically undergo large movements and bending loads due to waterhammer.

Note: Thrust forces from flow transients can open up joints in pipes connected by mechanical joints or bell-and-spigots. In this case, thrust blocks or thrust restraints are used to avoid opening the joints.

Two methods are used to analyze the effects of thrust loads: the static method and the dynamic method. With the static method, the thrust loads are calculated for each pipe segment, multiplied by the dynamic magnification factor and applied simultaneously to all pipe segments. In contrast, the dynamic analysis recognizes that the pressure wave travels in the pipeline at the speed of sound; therefore, the thrust force temporarily is applied to each segment by means of a time-history analysis. The time-history analysis requires a soil-pipe model and a series of thrust-force time tables—one for each straight pipe segment.

13.3 Example

An 18-inch standard size (0.375-inch wall, flow area 233.7 in²) ASTM A 106 Grade B carbon steel water pipe is buried 7-feet underground. The pipe is 1000 feet long with several bends. The water pressure is 150 psi and flows at 4 feet per second. The line should be designed for an

accidental closure of an isolation valve, in 50 milliseconds. The velocity of sound is 4500 feet per second.

The critical closing time is $t_c = 2(1000)/4500 = 0.44$ sec. Since $50 \text{ msec} = 0.05 \text{ sec} < 0.44 \text{ sec}$, the accidental valve closure can be considered instantaneous, and the upstream pressure rise during the ensuing waterhammer event is:

$$dP = (62.3)(4500)(4)/[(32.2)(144)] = 242 \text{ psi}$$

The hoop stress due to the waterhammer is:

$$\sigma_{hw} = \frac{(150 + 242)(18)}{2(0.375)} = 9408 \text{ psi}$$

The thrust load F is an impulse force axial to the pipe, applied successively along each straight segment, caused by the pressure imbalance of 242 psi between consecutive bends. Without more detailed analysis, the maximum value 2.0 of the dynamic magnification factor is applied to the thrust force to obtain the impulsive force. Therefore, the unbalanced impulsive force is:

$$F = 2 dP A_f = 2 (242)(233.7) = 113,110 \text{ lb}$$

The thrust force can then be applied to a pipe-soil model to obtain displacement and bending stresses, using either a conservative static approach or a time-history analysis as described in Section 13.2.

14.0 In-Service Relocation

14.1 Applied Load

In-service pipeline relocation is practiced routinely in the industry in order to perform certain operations without taking the line out of service. Some typical reasons for relocating an in-service pipeline include: accommodating a new highway or rail crossing, performing over-the-ditch coating renovation, inspecting or repairing pipe submerged in shallow water, or avoiding encroachment. Such operations increase the longitudinal stresses in the relocated section of pipeline. The pipeline may be lowered, raised, or moved laterally, and the imposed deflection and resulting stresses may be temporary or permanent, depending on the circumstances.

Consider an initially straight, level pipeline displaced laterally in any plane vertically or horizontally, with an amount H , as shown in the pipeline lowering scenario in Figures 14.1-1 and 14.1-2. The displaced alignment is assumed to be distributed as a series of constant-radius arcs within a transition length, L_1 which may or may not be separated by an obstruction length, L_2 . The total length of pipe to be excavated is then:

$$L_T = 2L_1 + L_2 \quad (14-1)$$

L_T is assumed to be long enough that the pipeline has the flexibility to conform to the imposed displacement. If total stresses are held to reasonable levels, this will generally be the case.

Two new longitudinal stresses associated with the displaced pipe alignment will develop and remain present as long as the pipe remains in the displaced configuration. One stress is a bending stress calculated as:

$$\sigma_b = \frac{2EDX}{L_1^2} \quad (14-2)$$

where E is the elastic modulus for steel, and D is the pipe diameter. This stress occurs only in the transition sections. The other added stress is an axial tension stress from extending the pipe over a longer path, calculated as:

$$\sigma_a = \frac{8}{3} \left(\frac{X}{L_T} \right)^2 E = \frac{8}{3} \left(\frac{X}{2L_1 + L_2} \right)^2 E \quad (14-3)$$

In addition to the two stresses described above, bending stresses associated with spanning effects between lift or support points along the pipeline may also develop. These spanning stresses can be estimated as:

$$\sigma_{bs} = \frac{wL_s^2 D}{20I} \quad (14-4)$$

where w is the net unit weight of the pipe, coating, and contents; L_s is the span or spacing between temporary lift or support points; and I is the pipe moment of inertia. If the pipe is being lowered to a new trench profile, these spanning stresses disappear once the pipe is resting on the new trench bottom. If the pipe is being raised, the spanning stresses remain in place along with the bending and extensional stresses until the pipe is lowered back into its original configuration.

Longitudinal stresses due to internal pressure (σ_{lp}) and thermal expansion (σ_t) are likely to be present as well if the pipeline remains in operation during the relocation process. Calculation of these stress components are addressed elsewhere in this document. Where the thermal expansion stress is compressive, it should be considered to be substantially relieved by the lateral displacement. Where the thermal expansion stress is tensile, it should be considered to remain in effect.

14.2 Evaluation

The concurrent stresses from operation and displacement of the pipeline should be summed algebraically as:

$$\sigma_{total} = \sigma_b + \sigma_a + \sigma_{bs} + \sigma_{lp} + \sigma_t \leq S_{allow} \quad (14-5)$$

All of the final stresses (with the possible exception of the term σ_{bs}) are displacement-controlled, sometimes referred to as “secondary” stresses.

New pipelines are rarely relocated because they can usually be designed and built to avoid a planned encroachment, and typically do not need extensive coating renovation for many years. Relocation is most often performed on a line that already has a long service history. Consequently, the allowable limit of total stress, S_{allow} , depends on a number of factors pertinent to older pipelines, including, but not limited to, the condition and operating history of the pipeline, the quality and inspection history of girth welds, the presence of repair appurtenances welded onto the pipe within the affected length, fracture toughness properties of the pipe and welds, actual strength properties of the pipe in the longitudinal axis, and risk factors associated with the location of the pipeline.

For a pipeline in sound overall condition and constructed from pipe and girth welds that exhibit good ductility at the minimum operating temperature, S_{allow} may approach or exceed the specified minimum yield strength (SMYS) of the pipe metal without adverse consequences. A limit state or strain-based design criterion may be useful for establishing S_{allow} in those cases. Where considerations of the pipeline’s age, condition, or ductile properties warrant, S_{allow} should be limited to levels below SMYS. A fitness-for-service or critical engineering assessment may be useful in establishing a safe level of S_{allow} in those cases. Other factors to consider when establishing S_{allow} include permanent or temporary added stresses, pressure levels during the relocation process, and the consequences of a failure.

The applied stresses should be maintained at levels less than the available stress margin, so:

$$\sigma_b + \sigma_a \leq S_{allow} - (\sigma_{bs} + \sigma_{lp} + \sigma_t) \quad (14-6)$$

This can be rewritten as:

$$\frac{2EDX}{L_1^2} + \frac{8}{3} \left(\frac{X}{2L_1 + L_2} \right)^2 E \leq S_{allow} - (\sigma_{bs} + \sigma_{lp} + \sigma_t) \quad (14-7)$$

The difference between S_{allow} and operating stresses will effectively establish the maximum X achievable within a given length of pipeline L_T , or the minimum L_T required in order to achieve a desired displacement X .

If $L_2 = 0$, the minimum trench length L_T required to achieve a lateral displacement X within the allowable stress can be solved for exactly as:

$$L_T = 2L_1 > \left[\frac{(8EX)(D + X/3)}{S_{allow} - (\sigma_{bs} + \sigma_{lp} + \sigma_t)} \right]^{1/2} \quad (14-8)$$

If L_2 is nonzero, L_T can be conservatively estimated by adding the estimate for $2L_1$ given above to L_2 . Alternatively, an optimum L_1 could be solved by trial and error. In general, L_2 must be specified from the layout of the problem before determining L_1 .

The radius of curvature of the transition arcs is:

$$R_c = \frac{1}{X} \left[\left(\frac{L_1}{2} \right)^2 + \left(\frac{X}{2} \right)^2 \right] \quad (14-9)$$

14.3 Example

A 12-inch standard carbon steel pipe is lowered 2 feet over a 400-foot span ($L_1 = 200$ ft), with no obstruction length ($L_2 = 0$). The bending stress is:

$$\sigma_b = \frac{2(29E6)(12.75)(2 \times 12)}{(200 \times 12)^2} = 3081 \text{ psi}$$

The axial stress due to pipe extension is:

$$\sigma_a = \frac{8}{3} \left(\frac{2}{2 \times 200} \right)^2 (29E6) = 1933 \text{ psi}$$

14.4 Figures

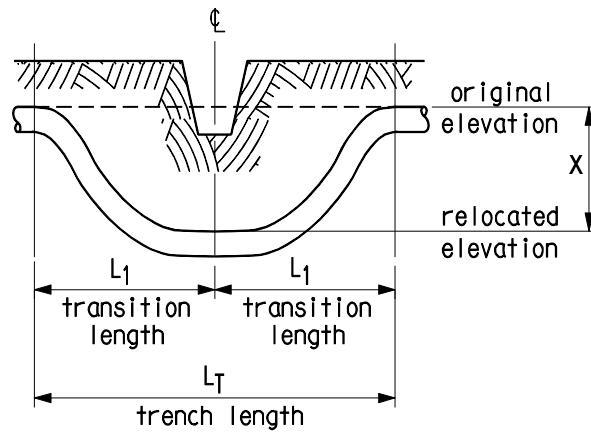

Figure 14.1-1 Pipeline Lowering with Transition Lengths L_1

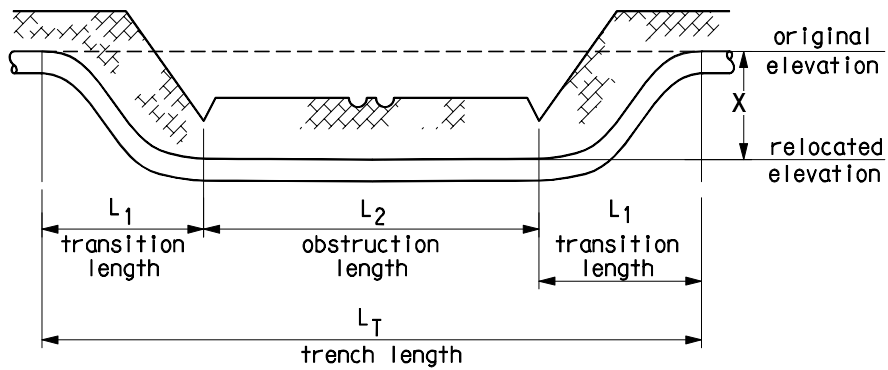

Figure 14.1-2 Pipeline Lowering with Transition Lengths L_1 and Obstruction Length L_2

References and Bibliography

- AISI, 1971, "Handbook of Steel Drainage and Highway Construction Products," American Iron and Steel Institute, Lakeside Press.
- ASCE, 1995, Al-Chaar et. al, "Seismic Assessment of Buried Pipelines," Technical Council on Lifeline Earthquake Engineering, Monograph no. 6.
- ASCE, 1984, "Guidelines for the Seismic Design of Oil and Gas Pipeline Systems," Committee on Gas and Liquid Fuel Lifelines.
- ASME B31.1, "Power Piping," 1998, American Society of Mechanical Engineers, New York, New York.
- ASME B31.3, "Process Piping," 1996, American Society of Mechanical Engineers, New York, New York.
- ASME B31.4, "Liquid Transportation Systems for Hydrocarbons, Liquid Petroleum Gas, Anhydrous Ammonia, and Alcohols," American Society of Mechanical Engineers, New York, New York.
- ASME B31.5, "Refrigeration Piping," 1992, American Society of Mechanical Engineers, New York, New York.
- ASME B31.8, "Gas Transportation and Distribution Piping Systems," American Society of Mechanical Engineers, New York, New York.
- ASME B31.9, "Building Services," 1996, American Society of Mechanical Engineers, New York, New York.
- ASME B31.11, "Slurry Transportation Piping Systems," 1989, American Society of Mechanical Engineers, New York, New York.
- Antaki, G., Welding Research Council Bulletin 425, "A Review of Methods for the Analysis of Buried Pressure Piping," WRC, New York, New York, September, 1997.
- AutoPIPE Pipe Stress Analysis User Guide, Appendix D, Rebis, Walnut Creek, California, 1999.
- Audibert, J.M.E. and Nyman, K.J., "Soil Restraint Against Horizontal Motion of Pipe," *Journal of Geotechnical Engineering*, American Society of Civil Engineers, Volume 103, Number GT10, pp. 1119-1142, October 1977.
- AWWA C-150/A21.51 91, "Thickness Design of Ductile Iron Pipe, American Water Works Association," Denver, Colorado.
- AWWA C-151/A21.51 91, "Ductile Iron Pipe, Centrifugally cast, for water or Other Liquids," American Water Works Association, Denver, Colorado.
- AWWA C-200, "Standard for Steel Water Pipe 6 in and Larger," American Water Works Association, Denver, Colorado.

AWWA C-900 89, "Polyvinyl Chloride Pressure Pipe, 4in. Through 12in., for Water Distribution," American Water Works Association, Denver, Colorado.

AWWA M-11, 89, "Steel Pipe – A Guide for Design and Installation," American Water Works Association, Denver, Colorado.

AWWA M-23 80, "PVC Pipe – Design and Installation," American Water Works Association, Denver, Colorado.

AWWA M-45 96, "Fiberglass Pipe Design," American Water Works Association, Denver, Colorado.

AWWA Journal, *Standard Allowances for Waterhammer*, Volume 44, Number 11, November 1952.

Bandyopadhyay, K., et. al., "Seismic Design and Evaluation Guidelines for the Department of Energy High-Level Waste Storage Tanks and Appurtenances," BNL-52361, 1995.

Code of Federal Regulations Title 49, Transportation, Part 195, "Transportation of Hazardous Liquids by Pipeline."

Esparza, E.D., P.S. Westine and A.B. Wenzel, "Pipeline Response to Buried Explosive Detonations," Volume 1, Southwest Research Institute Report to the American Gas Association, AGA Project PR-15-109, 1981.

Esparza, E.D., "Pipeline Response to Blasting in Rock," Southwest Research Institute Report to the American Gas Association, AGA Project PR-15-712, 1991.

FEMA-233, July 1992, "Earthquake Resistant Construction of Gas and Liquid Fuel Pipeline Systems Serving, or Regulated by, the Federal Government," Federal Emergency Management Agency, Washington, DC.

Goodling, E.C., "Buried Piping – An Analysis Procedure Update" ASME PVP, 1983.

Goodling, E.C., "Quantification of Nonlinear Soil Restraint in the Analysis of Restrained Underground Piping," PVP, Volume 356, Integrity of Structures and Fluid Systems, Piping and Pipe Supports, and Pumps and Valves, American Society of Mechanical Engineers, 1997, pp. 107-116.

Gresnigt, A.M., "Plastic Design of Buried Steel Pipelines in Settlement Areas," *Heron*, Volume 31, Number 4, 1986.

Hall, W.J. and Newmark, N.M., "Seismic Design Criteria for Pipeline Facilities," Proceedings of the Conference on the Current State of Knowledge of Lifeline Earthquake Engineering, American Society of Civil Engineering, 1977.

Hetenyi, M., *Beams on Elastic Foundation*, The University of Michigan Press, 1946.

Howard, A., "Modulus of Soil Reaction Values for Buried Flexible Pipe," *Journal of Geotechnical Engineering*, ASCE, January 1977.

Honneger, D.G., "Evaluating Pipeline Performance for Earthquake Induced lateral Spread Ground Movement," ASME PVP, 1997.

ISO/DIS 13623, Draft, 1998.

Kim, H.O. and D.C. Chang, "Method Yields Download Force to Arrest Upheaval Buckling in Offshore Lines," *Oil & Gas Journal*, July 26, 1999.

Krizek, R.J., Parmelee, R.A., Kay, J.N. and Elnaggar, H.A., "Structural Analysis and Design of Pipe," HCHRP Report 116, 1971.

Luscher, U., "Buckling of Soil Surrounded Tubes," *Journal of Soil Mechanics and Foundation*, ASCE, November 1966.

Manual of Recommended Practice, *American Railway Association, AREA Spec 1-4-28*, Chicago, Illinois.

Marston, A., "The Theory of External Loads on Closed Conduits in the Light of the Latest Experiments," Proceedings, Ninth Annual Meeting Highway Reserve Board, December 1929.

Meyershon, W.D., "Analytical and Design Considerations for the Seismic Response of Buried Pipelines," Thesis paper, Cornell University Graduate School, January 1991.

Moser, A.P., *Buried Pipe Design*, McGraw Hill, 1990.

National Corrugated Steel Pipe Association, "Airport Runway Depth of Cover Tables," Shiller Park, Illinois.

NFPA-24, "Private Fire Service Mains and Their Appurtenances," National Fire Protection Association, 1995.

Nyman, D.J., et. al., "Guidelines for the Seismic Design of Oil and Gas Pipeline Systems," Committee on Gas and Liquid Fuel Pipelines, ASCE, Technical Council on Lifeline Earthquake Engineering, New York, New York, 1984.

O'Rourke, M.J. and Liu, J., "Seismic Loading Behavior of Buried Pipelines," ASME PVP, 1998.

O'Rourke, M.J. and Liu, X., "Response of Buried Pipelines Subject to earthquake Effects," Monograph Number 5, Multidisciplinary Center for Earthquake Engineering Research, SUNY-Buffalo, New York, 1999.

Peng, S. S., "Surface Subsidence Engineering," Society for Mining, Metallurgy, and Exploration, Inc., Littleton, Colorado, 1992.

PIPLIN-PC "Stress and Deformation Analysis of Pipelines," Version 4.0 Arctic, User Reference and Theoretical Manual, SSD Inc., Reno, Nevada, 2000.

Rizkalla, M., Trigg, A., and Simmonds, G., "Recent Advances in the Modeling of Longitudinal Pipeline/Soil Interaction for Cohesive Soils," 1996 OMAE, Volume V, Pipeline Technology, ASME 1996.

Spangler, M.G. and Handy, R. L., *Soil Engineering*. Harper & Row, Publishers, New York, New York, 4th Edition, 1982.

Spangler, M.G., "Underground Conduits – An Appraisal of Modern Research," *Transactions of the American Society of Civil Engineers*, Volume 113, pp. 316-345, 1948.

Spangler, M.G., "The Structural Design of Flexible Pipe Culverts," Iowa State College Bulletin 153, Ames, Iowa, 1941.

Stephens, D.R., et. al., "Pipeline Monitoring – Limit state Criteria," Batelle Report NG-18, Number 188, AGA, 1991.

Trautmann, C.H. and O'Rourke, T.D., "Lateral Force-Displacement Response of Buried Pipes," *Journal of Geotechnical Engineering*, ASCE, Volume 111, Number 9, pp. 1077-1092, September 1985.

Uni-Bell PVC Pipe Association, "Handbook of PVC Pipe Design and Construction," Uni-Bell PVC Pipe Association, Dallas, Texas.

Watkins, R.K. and Moser, A.P., "Soil and Surface Loads on Buried Pipes Including Minimum Cover Requirements," ASME PVP, Volume 360, 1998.

Watkins, R.K. and Spangler, M.G., "Some Characteristics of the Modulus of Passive Resistance of Soil: A Study in Similitude," *Highway Research Board Proceedings*, 37:576, 1958.

Watkins, R.K. and Anderson, L.R., *Structural Mechanics of Buried Pipes*, CRC Press, Boca Raton, Florida, 1999.

Appendix A: Suggested Acceptance Criteria

Acceptance criteria, whether defined by allowable loads, stresses, deformations or strains, should be consistent with the desired level of pipeline performance. The following acceptance criteria are suggested for most applications. The criteria for a particular buried pipe should be established on a case-by-case basis.

Loading Condition	Allowable Load or Stress	Allowable Deformation or Strain
Hoop stress from internal pressure and fluid transients	Code allowable for internal pressure	N/A
Through-wall bending from earth loads (static, live, surface impact)	Bending stress $< 0.5 \sigma_y$	N/A
Hoop compression from earth loads (static, live, surface impact)	Compressive stress $< 0.5 \sigma_y$	N/A
Ring buckling from earth loads (static, live, surface impact)	Compressive load $< \frac{1}{FS} \sqrt{32R_w B' E' \frac{EI}{D^3}}$	Strain limits: Mortar-lined and coated = 2% D Mortar-lined & flexible coated = 3% D Flexible lining & coated = 5% D
Bending stress from buoyancy	Bending stress $< \sigma_y^6$	Strain limits: Tension: 0.5% Compression: 0.5%
Thermal expansion	Code allowable for secondary loading ¹	N/A
Movement at bends	Code allowable for primary loading ¹	N/A
Longitudinal strain from ground movement due to earthquake, landslide, or mine subsidence, combined with thermal strain	N/A ²	Operable limits ^{4,5} Tension strain limit 2% Compression strain limit $0.50 \left(\frac{t}{D'} \right) - 0.0025 + 3000 \left(\frac{pD}{2Et} \right)^2$ $D' = \frac{D}{1 - \frac{3}{D}(D - D_{\min})}$ Pressure integrity limits ^{4,5} Tension strain limit 4% Compression strain limit $1.76 \frac{t}{D}$
Wave propagation ^{4,5}	Bending stress $< \sigma_y$	Tension strain limit 0.5%

Loading Condition	Allowable Load or Stress	Allowable Deformation or Strain
		<p>Compression strain limit</p> $0.75 \left[0.50 \left(\frac{t}{D'} \right) - 0.0025 + 3000 \left(\frac{pD}{2Et} \right)^2 \right]$ $D' = \frac{D}{1 - \frac{3}{D}(D - D_{\min})}$
Longitudinal and hoop stresses from blasting	Longitudinal + Hoop stress < 0.9 σ_y	N/A
Overpressure from fluid transients	Code allowable for overpressure	N/A
Unbalanced loads from fluid transients	Code allowable	N/A
Bending from in-service relocation	(see note 3)	(see note 3)
<p>Notes:</p> <ol style="list-style-type: none"> Code allowables apply, as these loading conditions are assumed to be repetitive operational loads requiring the pipe to maintain sufficient margins against fatigue damage. The permissible ground deformations that might be estimated using allowable stress criteria are typically too small to be of practical importance. The strain criteria for operating conditions assumes a single event and provides a criteria related to the maximum moment capacity of the pipe. The strain criteria for pressure integrity assumes ovalization of the pipe cross-section with a possibility of local wrinkling of the pipe wall. Pipe repair would be required to return the pipe to normal service. Allowable stresses or strains associated with in-service relocation are based on a case-specific assessment of an existing pipeline. This includes evaluation of potential weld and corrosion defects and generally requires special expertise to determine appropriate stress or strain criteria. Suggested strain limits greater than the nominal yield strain assume butt-welded construction with weld consumables, welding procedures, and inspection criteria sufficient to assure development of gross section yielding of the pipe cross section. This may require more stringent welding procedures, special inspection, or, in special cases, confirmation through laboratory testing. Pressure integrity strain limits assume that significant pipeline distortion is possible and pipeline repair or replacement may be necessary. A larger allowable for buoyancy is necessary to assure stability and assumes the pipeline will be relocated to original condition once buoyant displacements are identified. 		

Appendix B: Soil Spring Representation

Soil loading on the pipeline is represented by discrete nonlinear springs (e.g., elastic-plastic, multi-linear) as illustrated in Figure B.1. The maximum soil spring forces and associated relative displacements necessary to develop these forces are computed using the equations given in the following sections.

Soil properties representative of the backfill should be used to compute axial soil spring forces. Other soil spring forces should generally be based on the native soil properties. Backfill soil properties are appropriate for computing horizontal and upward vertical soil spring forces only when it can be demonstrated that the extent of pipeline movement relative to the surrounding backfill soil is not influenced by the soils outside the pipe trench.

Although tests have indicated that the maximum soil force on the pipeline decreases at large relative displacements, these guidelines are based on the assumption that the soil force is constant once it reaches the maximum value. The dimension for the maximum soil spring force is force per unit length of pipeline. The equations in this Appendix are based on buried pipelines in uniform soil conditions.

For deeply buried pipelines with variable soil properties between the ground surface and the pipeline depth, the equations in this Appendix may not be representative of true soil loading conditions. Guidance on how to proceed with variable soil conditions is provided in the Commentary section.

Horizontal soil loads of offshore pipelines resting on the sea floor increase more gradually with displacement due to the formation of a soil mound in front of the pipeline. Determination of the soil spring characteristics for this condition requires special treatment by experienced practitioners and is not covered in these guidelines.

The expressions for maximum soil spring force are based on laboratory and field experimental investigations on pipeline response, as well as general geotechnical approaches for related structures such as piles, embedded anchor plates, and strip footings. Several of the equations have been derived to fit published curves to facilitate their use in spreadsheets or other computer-based applications.

B.1 Axial Soil Springs

The maximum axial soil force per unit length of pipe that can be transmitted to the pipe is:

$$T_U = \pi D \alpha c + \pi D H \bar{\gamma} \frac{-1 + K_0}{2} \tan \delta \quad (\text{B-1})$$

where:

- D = pipe outside diameter
- c = soil cohesion representative of the soil backfill
- H = depth to pipe centerline
- $\bar{\gamma}$ = effective unit weight of soil

- K_o = coefficient of pressure at rest
- α = adhesion factor (curve fit to plots of recommended values in Figure B.2)
- $\alpha = 0.608 - 0.123c - \frac{0.274}{c^2 + 1} + \frac{0.695}{c^3 + 1}$ where c is in ksf or kPa/100
- δ = interface angle of friction for pipe and soil = $f\phi$
- ϕ = internal friction angle of the soil
- f = coating dependent factor relating the internal friction angle of the soil to the friction angle at the soil-pipe interface

Representative values of f for various types of external pipe coatings are provided in the following table:

Pipe Coating	f
Concrete	1.0
Coal Tar	0.9
Rough Steel	0.8
Smooth Steel	0.7
Fusion Bonded Epoxy	0.6
Polyethylene	0.6

Table B.1 Friction factor f for Various External Coatings

- Δ_t = displacement at T_u
- = 0.1 inches (3 mm) for dense sand
- = 0.2 inches (5 mm) for loose sand
- = 0.3 inches (8 mm) for stiff clay
- = 0.4 inches (10 mm) for soft clay

B.2 Lateral Soil Springs

The maximum lateral soil force per unit length of pipe that can be transmitted to the pipe is:

$$P_u = N_{ch}cD + N_{qh}\bar{\gamma}HD \quad (\text{B-2})$$

where:

- N_{ch} = horizontal bearing capacity factor for clay (0 for $c = 0$)
- N_{qh} = horizontal bearing capacity factor (0 for $\phi = 0^\circ$)

The expressions below for N_{ch} and N_{qh} are closed form fits to published empirical (plotted) results (see Figure B.3).

N_{ch} = horizontal bearing capacity factor for clay (0 for $c = 0$)

$$= a + bx + \frac{c}{(x+1)^2} + \frac{d}{(x+1)^3} \leq 9$$

N_{qh} = horizontal bearing capacity factors for sand (0 for $\phi = 0^\circ$)

$$= a + b(x) + c(x^2) + d(x^3) + e(x^4)$$

Factor	ϕ	x	a	b	c	d	e
N_{ch}	0°	H/D	6.752	0.065	-11.063	7.119	--
N_{qh}	20°	H/D	2.399	0.439	-0.03	$1.059(10)^{-3}$	$-1.754(10)^{-5}$
N_{qh}	25°	H/D	3.332	0.839	-0.090	$5.606(10)^{-3}$	$-1.319(10)^{-4}$
N_{qh}	30°	H/D	4.565	1.234	-0.089	$4.275(10)^{-3}$	$-9.159(10)^{-5}$
N_{qh}	35°	H/D	6.816	2.019	-0.146	$7.651(10)^{-3}$	$-1.683(10)^{-4}$
N_{qh}	40°	H/D	10.959	1.783	0.045	$-5.425(10)^{-3}$	$-1.153(10)^{-4}$
N_{qh}	45°	H/D	17.658	3.309	0.048	$-6.443(10)^{-3}$	$-1.299(10)^{-4}$

N_{qh} can be interpolated for intermediate values of ϕ between 20° and 45° .

Δ_p = displacement at P_u

$$= 0.04 \left(H + \frac{D}{2} \right) \leq 0.10D \text{ to } 0.15D$$

B.3 Vertical Uplift Soil Springs

The equations for determining upward vertical soil spring forces are based on small-scale laboratory tests and theoretical models. For this reason, the applicability of the equations is limited to relatively shallow burial depths, as expressed as the ratio of the depth to pipe centerline to the pipe diameter (H/D). Conditions in which the H/D ratio is greater than the limit provided below require case-specific geotechnical guidance on the magnitude of soil spring force and the relative displacement necessary to develop this force.

$$Q_u = N_{cv}cD + N_{qv}\bar{\gamma}HD \quad (\text{B-3})$$

where:

N_{cv} = vertical uplift factor for clay (0 for $c = 0$)

N_{qv} = vertical uplift factor for sand (0 for $\phi = 0^\circ$)

$$N_{cv} = 2\left(\frac{H}{D}\right) \leq 10 \quad \text{applicable for } \left(\frac{H}{D}\right) \leq 10$$

$$N_{qv} = \left(\frac{\phi H}{44D}\right) \leq N_q \quad (\text{See Section B.4 for definition of } N_q)$$

The above equations represent an approximation to published results such as those illustrated in Figure B.4.

$$\begin{aligned} \Delta_{qu} &= \text{displacement at } Q_u \\ &= 0.01H \text{ to } 0.02H \text{ for dense to loose sands } < 0.1D \\ &= 0.1H \text{ to } 0.2H \text{ for stiff to soft clays } < 0.2D \end{aligned}$$

B.4 Vertical Bearing Soil Springs

$$Q_d = N_c cD + N_q \bar{\gamma}HD + N_\gamma \gamma \frac{D^2}{2} \quad (\text{B-4})$$

where:

$$\begin{aligned} N_c, N_q, N_\gamma &= \text{bearing capacity factors} \\ N_c &= [\cot(\phi + 0.001)] \{ \exp[\pi \tan(\phi + 0.001)] \tan^2 \left(45 + \frac{\phi + 0.001}{2} \right) - 1 \} \\ N_q &= \exp(\pi \tan \Phi) \tan^2 \left(45 + \frac{\phi}{2} \right) \\ N_\gamma &= e^{(0.18\phi - 2.5)} \quad (\text{this is a curve fit to plotted values of } N_\gamma \text{ in Figure B.5}) \\ \gamma &= \text{total unit weight of soil} \\ \Delta_{qd} &= \text{displacement at } Q_d \\ &= 0.1D \text{ for granular soils} \\ &= 0.2D \text{ for cohesive soils} \end{aligned}$$

B.5 References

Hansen, J.B., "The Ultimate Resistance of Rigid Piles Against Transversal Forces," Bulletin 12, Danish Geotechnical Institute, Copenhagen, Denmark, 1961.

Trautmann, C.H. and T.D. O'Rourke, "Behavior of Pipe in Dry Sand Under Lateral and Uplift Loading," Geotechnical Engineering Report 83-6, Cornell University, Ithaca, New York, 1983.

B.6 Figures

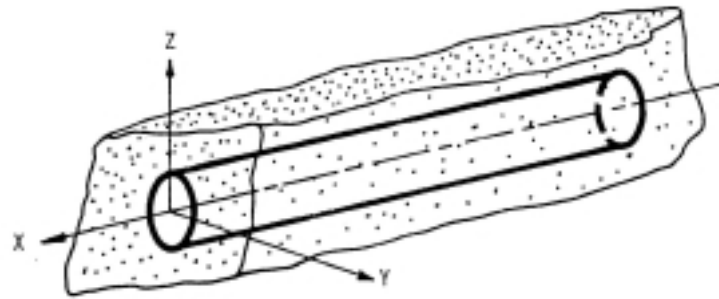

a) Actual Three-dimensional Soil Restraint on Pipeline

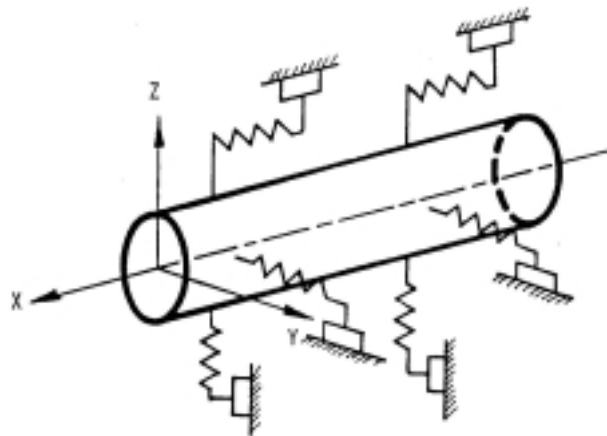

b) Idealized Representation of Soil with Discrete Springs

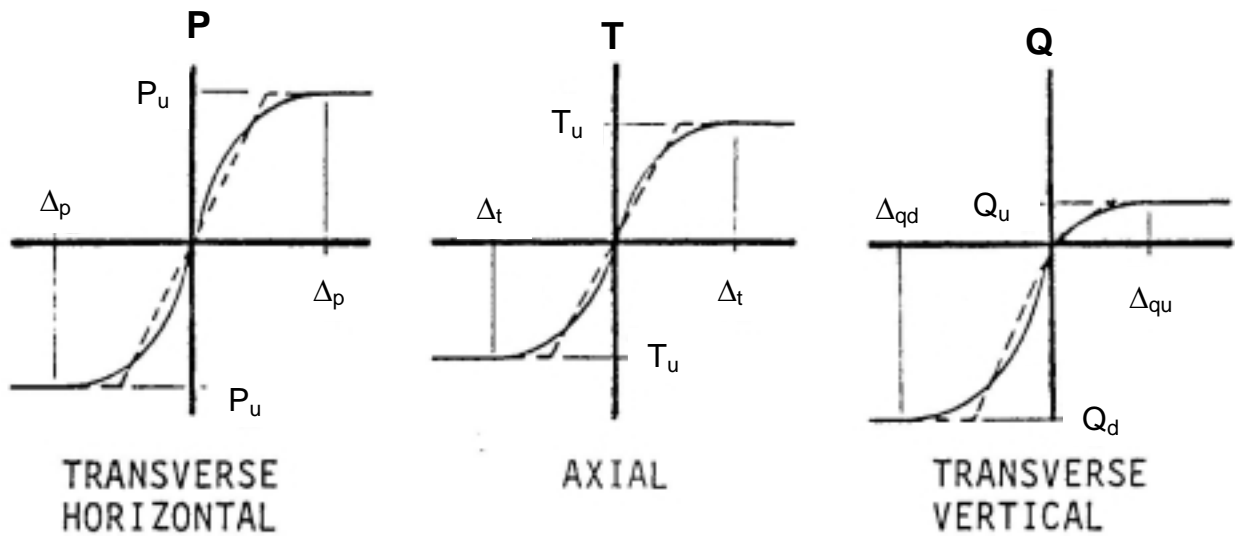

c) Bi-linear Soil Springs Used to Represent Soil Force on Pipe

Figure B.1 Pipeline Modeling Approach

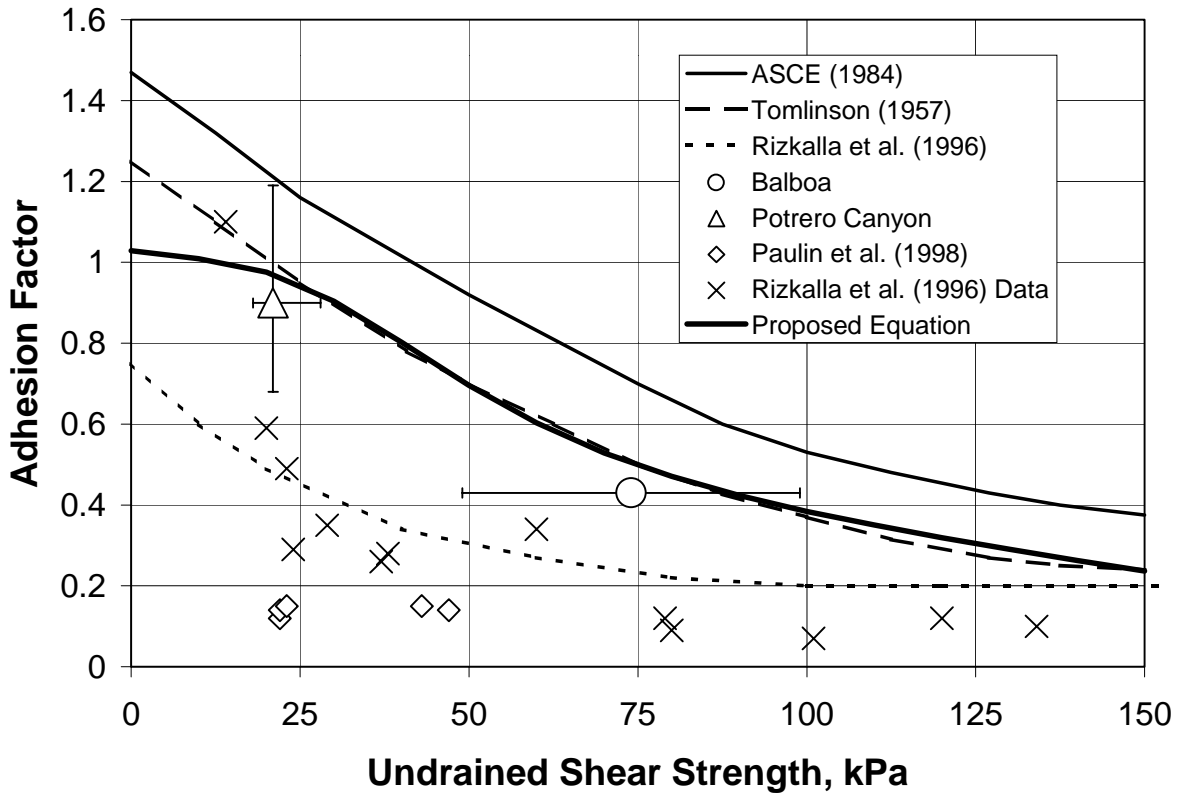

Figure B.2 Plotted Values for the Adhesion Factor, α

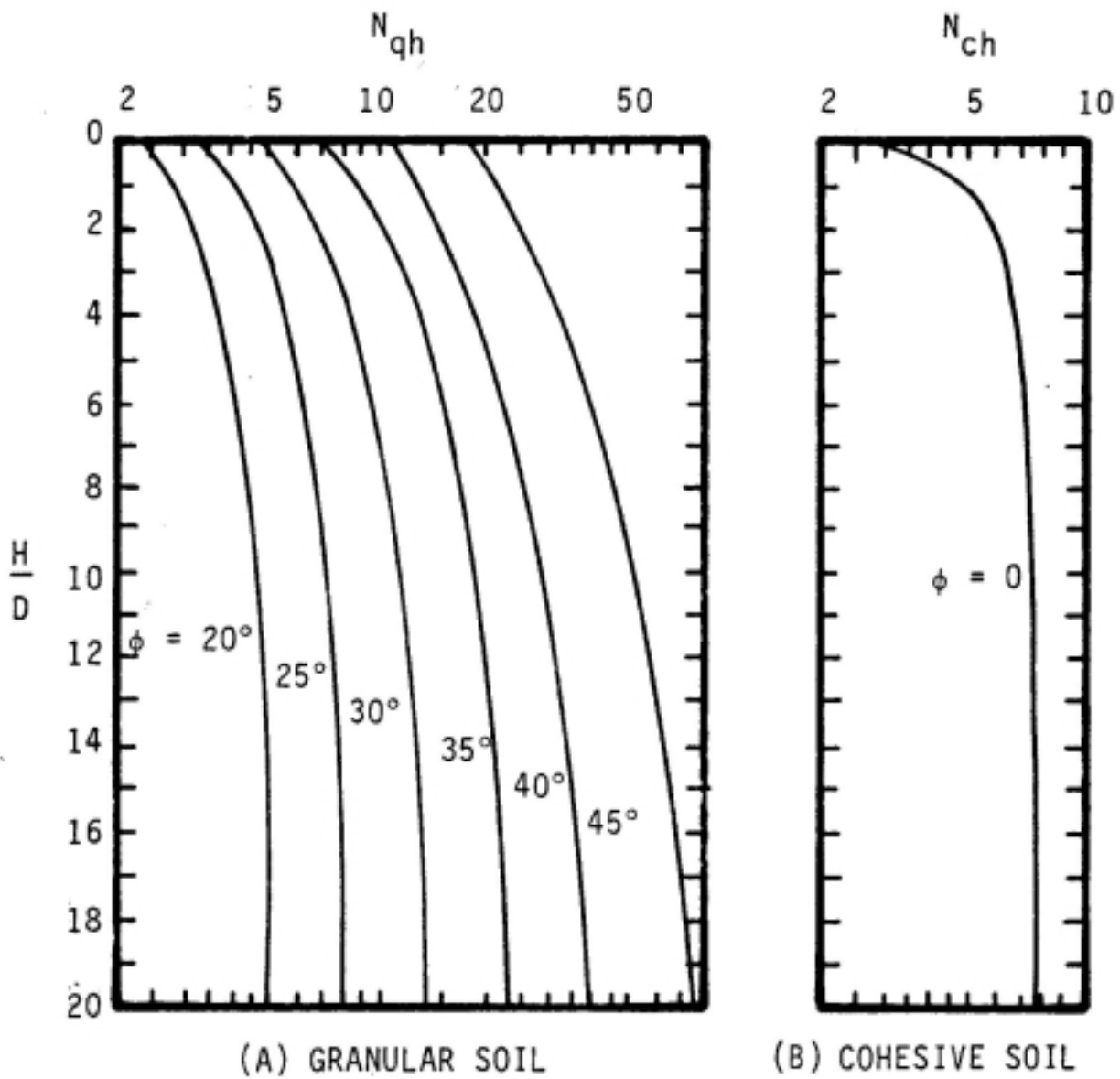

Figure B.3 Values of N_{qh} and N_{ch} of Hansen 1961

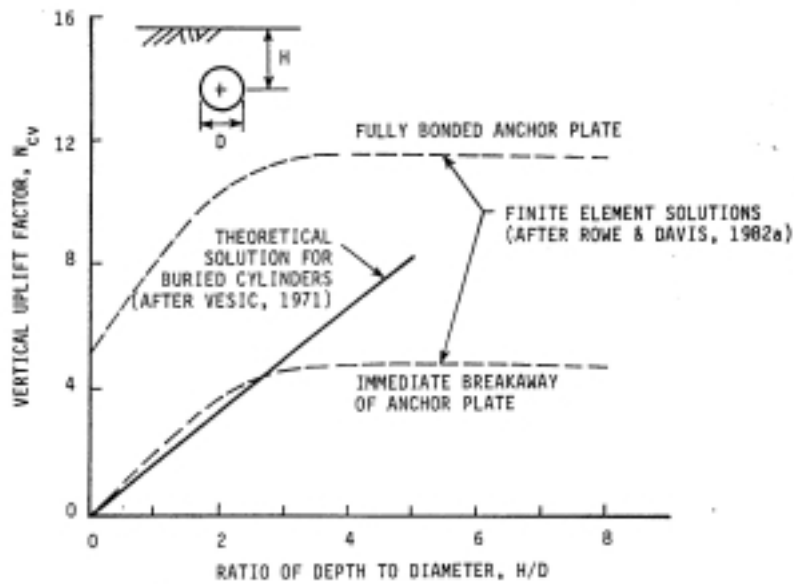
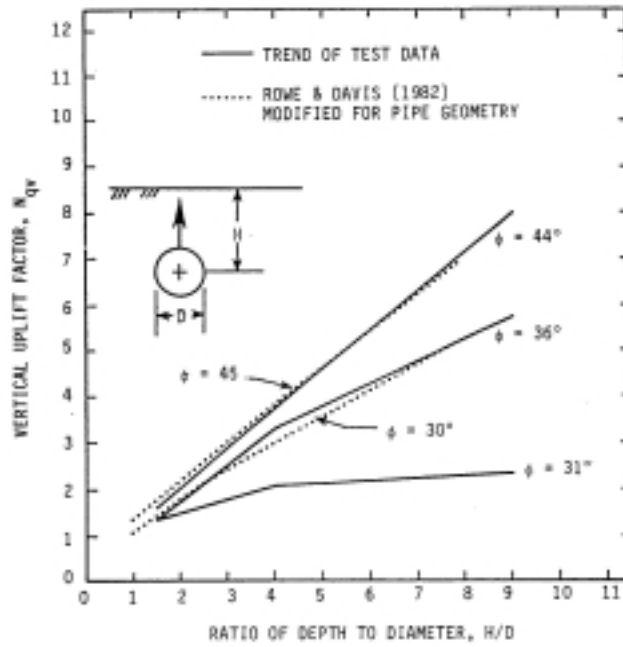

Figure B.4 Ranges for Values of N_{qv} and N_{cv} (from Trautman and O'Rourke, 1983)

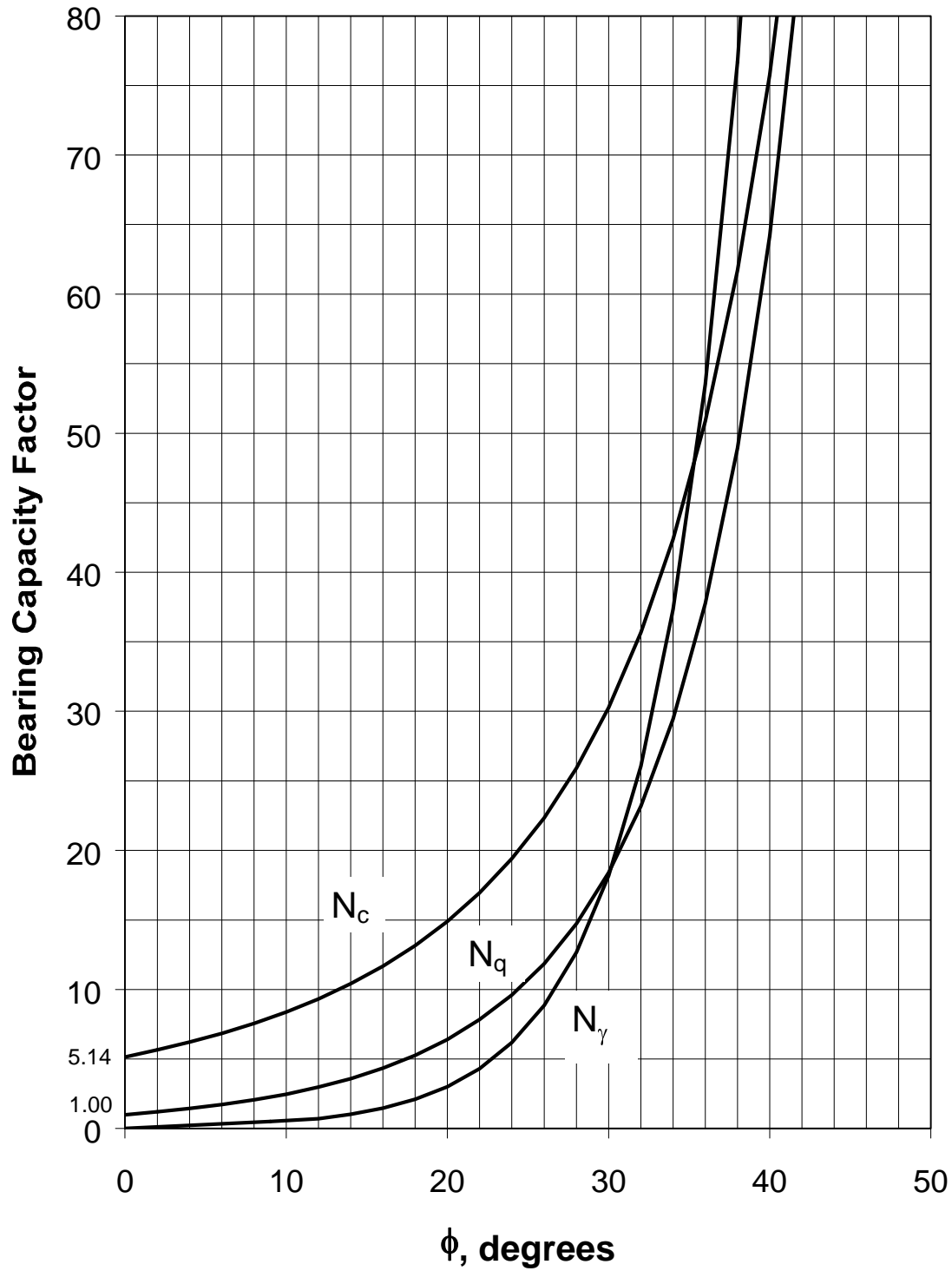

Figure B.5 Plotted Values of Bearing Capacity Factors (N_q , N_c , and N_γ)