



NEHRP Recommended Seismic Provisions for New Buildings and Other Structures

Volume I: Part 1 Provisions, Part 2 Commentary
FEMA P-2082-1/ September 2020



From Research to Improved Standards and Seismic Design Practice

Engineering Research: FEMA, NIST
U.S. Seismic Design Maps: FEMA/USGS

Post Earthquake Observations: FEMA, NIST, NSF, USGS

Basic Engineering Research: NSF

Field and Research Experience: Private Sector & Professional Societies

Local Buckling, Plate Slenderness, Axial Compression

Seismic Design:

$$\frac{b}{t_p} \leq 1.05 \sqrt{\frac{E}{R_y F_y}}$$
$$F_{cr} \geq F_y$$
$$F_{cr} = A_s F_y + 0.85 F_c' A$$

Section 3.2 - Hazard Changes (CEUS)

Ratio Maps (2018/2014): 2% in 50yr uniform hazard, BC site class (760 m/s)

Spandrel Panel Layout

Spandrel panel layout, connection from interior

Spandrel panel section at midspan

2020 NEHRP Recommended Seismic Provisions: Design Examples, Training Materials, and Design Flow Charts

FEMA P-2192-V2/November 2021

Volume II: Training Materials



FEMA



2020 NEHRP (National Earthquake Hazards Reduction Program) Recommended Seismic Provisions: Training Materials

Prepared for

Federal Emergency Management Agency

U.S. Department of Homeland Security

By

Building Seismic Safety Council

National Institute of Building Sciences

Washington, D.C.

NOTICE: Any opinions, findings, conclusions, or recommendations expressed in this publication do not necessarily reflect the views of the Federal Emergency Management Agency. Additionally, neither FEMA nor any of its employees make any warranty, expressed or implied, nor assume any legal liability or responsibility for the accuracy, completeness, or usefulness of any information, product, or process included in this publication.

The National Institute of Building Sciences (NIBS) brings together members of the building industry, labor and consumer interests, government representatives, and regulatory agencies to identify and resolve problems and potential problems around the built environment. NIBS is a nonprofit, non-governmental organization established by Congress in 1974.

The Building Seismic Safety Council (BSSC) was established in 1979 under the auspices of NIBS as a national platform for dealing with the complex regulatory, technical, social, and economic issues involved in developing and promulgating building earthquake hazard mitigation regulatory provisions that are national in scope. By bringing together in the BSSC all of the needed expertise and all relevant public and private interests, it was believed that issues related to the seismic safety of the built environment could be resolved and jurisdictional problems overcome through authoritative guidance and assistance backed by a broad consensus. BSSC's mission is to enhance public safety by providing a national forum that fosters coordination of and improvements in seismic planning, design, construction, and regulation in the building community.

This report was prepared under Contract HSFE60-15-D-0022 between the Federal Emergency Management Agency and the National Institute of Building Sciences.

This FEMA resource document can be obtained from the FEMA online library:
<https://www.fema.gov/emergency-managers/risk-management/building-science/earthquakes>.

2020 NEHRP Recommended Seismic Provisions: Design Examples, Training Materials, and Design Flow Charts

Volume II: Training Materials

FEMA P-2192-V2 Volume II *Training Materials*, as one of the 2020 *NEHRP Provisions*' supporting and educational products, contains a set of slides for use with FEMA P-2192-V1, Volume I *Design Examples*. The training materials are developed to correspond to each chapter in the Volume I *Design Examples* to provide background information, highlights of relevant code changes, and important application details.

The training materials are prepared to be suitable for use in self-learning, professional training courses, and university classes for teaching related provisions in the 2020 *NEHRP Recommended Seismic Provisions for New Buildings and Other Structures* (FEMA P-2082) and the ASCE/SEI 7-22 *Minimum Design Loads and Associated Criteria for Buildings and Other Structures*. This training material presentation is intended to remain complete in its entirety even if used by other presenters. While the training material could be tailored for use in other presentations, we caution users to account for issues of completeness and interpretation if only part of the material is used. We also strongly suggest users give proper credit/citation to this report and related chapter authors.

Images in the Volume II *Training Materials* presentations taken from the Volume I *Design Examples* or the *NEHRP Provisions* are typically not cited in the Volume II *Training Materials*. The full references for partial citations in the *Training Materials* presentations are typically given in the *Design Examples* references.

Table of Contents

Chapter 1 – Introduction to the 2020 NEHRP Provisions Design Examples, Bret Lizundia

Chapter 2 (Sections 2.1 to 2.6) – Fundamentals, James Harris

Chapter 2 (Section 2.7) – Resilience-Based Design, David Bonowitz

Chapter 3 (Section 3.2 – Part 1) – The 2018 Update of the USGS National Seismic Hazard Model, Sanaz Rezaeian

Chapter 3 (Section 3.2 – Part 2) – Dissection of the Example Changes to the MCE_R Ground Motion Values, Lucas Luco

Chapter 3 (Section 3.3) – New Multi-Period Response Spectra and Ground Motion Requirements, Charles A. Kircher

Chapter 3 (Section 3.4) – Additional Revisions to Ground-Motion Provisions, C.B. Crouse

Chapter 4 – Reinforced Concrete Ductile Coupled Shear Walls, S.K. Ghosh and Prabuddha Dasgupta

Chapter 5 – Seismic Design of Coupled Composite Plate Shear Walls/Concrete Filled (C-PSW/CF), Soheil Shafaei and Amit H. Varma

Chapter 6 – Cross-Laminated Timber (CLT) Shear Walls, Phillip Line and M. Omar Amini

Chapter 7 – Horizontal Diaphragm Design, Kelly Cobeen

Chapter 8 – Nonstructural Components: Fundamentals and Design Examples, Bret Lizundia

Chapter 1 Introduction to the 2020 NEHRP Provisions Design Examples

2020 NEHRP Provisions Training Materials
Bret Lizundia, S.E., Rutherford + Chekene



FEMA



Building Seismic
Safety Council

BSSC



Learning Objectives

- Understand the role of the *NEHRP Provisions* in seismic code development
- Gain an awareness of seminal past seismic code changes
- Understand key updates to the 2020 *NEHRP Provisions* and to ASCE/SEI 7-22
- Understand what is contained in the 2020 *Design Examples* and how the document can be used

Acknowledgement: Images are taken from FEMA P-2192-V1 and FEMA P-2192-V2 unless otherwise noted.



FEMA

 Building Seismic Safety Council



Outline of Presentation

- Overview of the 2020 *NEHRP Provisions*
 - Intent
 - Relationship of the Provisions to ASCE/SEI 7-22
- Summary of notable earthquakes and their impact on seismic design
- History and role of the *NEHRP Provisions* in advancing seismic design
- Highlights of major updates in the *NEHRP Provisions* and seismic provisions of ASCE/SEI 7-22
- Introduction to the organization and content in the new *Design Examples*



FEMA



Building Seismic
Safety Council



Overview of the 2020 *NEHRP Provisions*

The *NEHRP Recommended Seismic Provisions*

- The starting point in the U.S. seismic standards development process
- Major ASCE/SEI 7 seismic analysis and design concepts originate in the *NEHRP Provisions*



FEMA



Building Seismic
Safety Council



Intent of the 2020 NEHRP Provisions

The *Provisions* are the “*minimum recommended requirements for design and construction of new buildings. The objectives of these provisions are to provide reasonable assurance of seismic performance that will:*

1. *Avoid serious injury and life loss due to*
 - a. *Structural collapse*
 - b. *Failure of nonstructural components or systems*
 - c. *Release of hazardous materials*
2. *Preserve means of egress*
3. *Avoid loss of function in critical facilities, and*
4. *Reduce structural and nonstructural repair costs where practicable.”*

From FEMA P-2082-1



FEMA

 Building Seismic Safety Council



From Research to Improved Standards and Seismic Design Practice

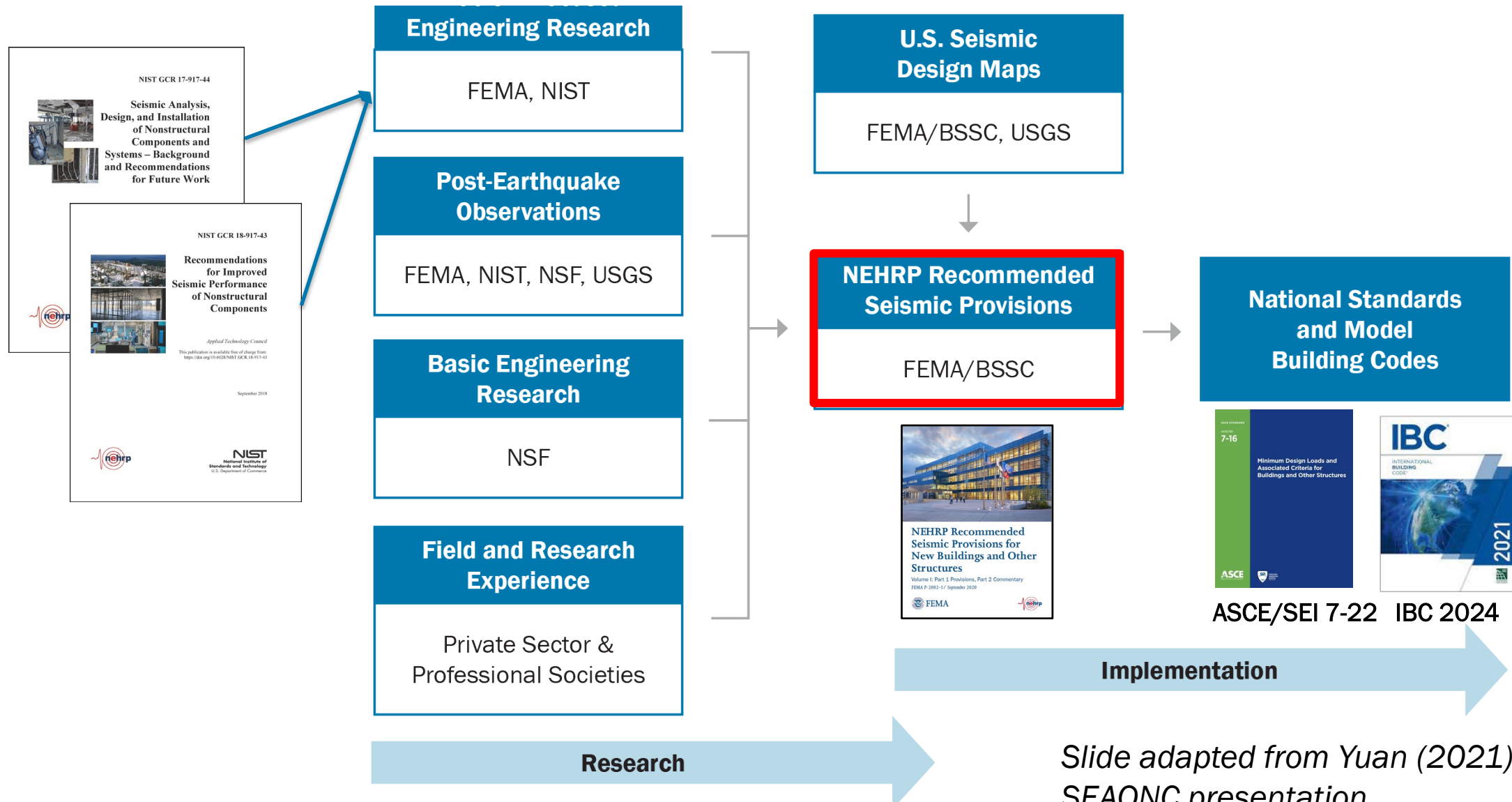

Slide adapted from Yuan (2021)
SEAONC presentation

How US Seismic Codes are Developed

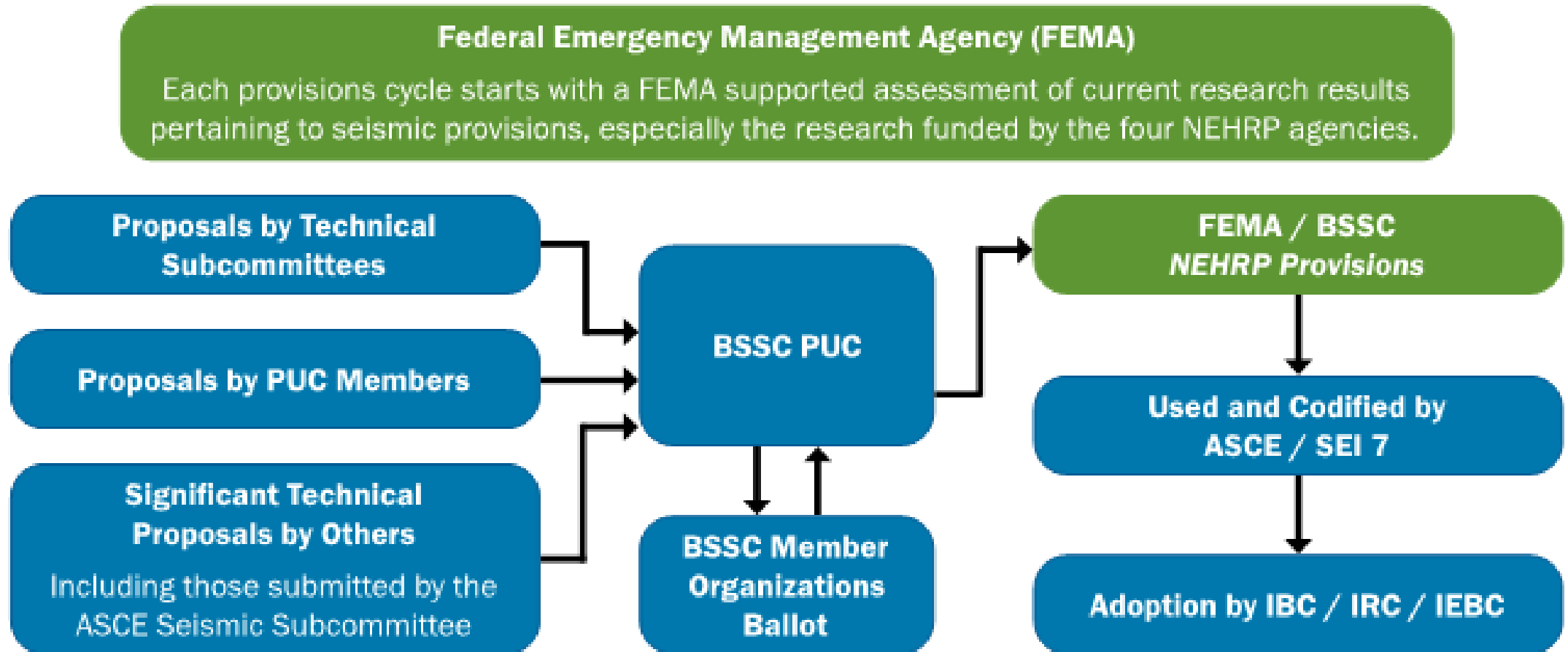

From FEMA P-2156



FEMA



Building Seismic
Safety Council



2020 NEHRP Provisions – BSSC Provisions Update Committee

Main Committee

23 voting members

7 non-voting advisors

Issue Teams

IT 1 - Seismic Performance Objectives

IT 2 - Seismic Resisting Systems and Design Coefficients

IT 3 - Modal Response Spectrum Analysis

IT 4 - Shear Wall Design

IT 5 - Nonstructural Components

IT 6 - Nonbuilding Structures

IT 7 - Soil Foundation Interaction

IT 8 - Base Isolation and Energy Dissipation

IT 9 - Diaphragm Issues

IT 10 - Seismic Design Maps (Project '17)



FEMA



Building Seismic
Safety Council



2020 NEHRP Provisions Organization

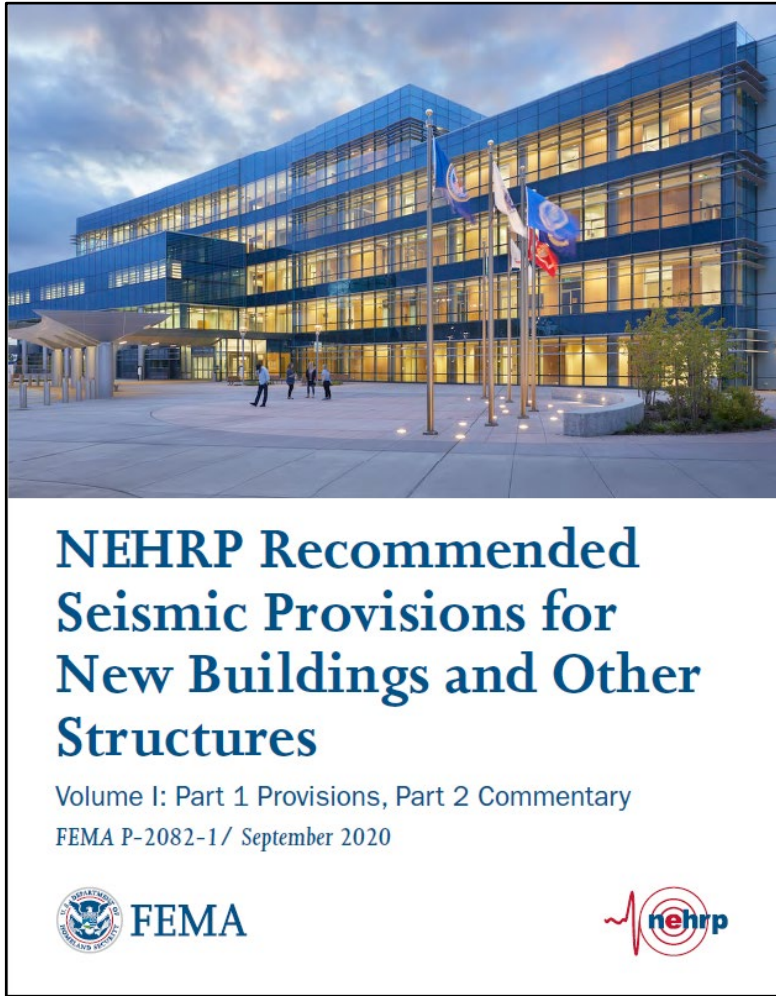

Part 1: Provisions

To introduce new provisions and modifications to improve current requirements in ASCE/SEI 7-16

Part 2: Commentary

A detailed commentary that corresponds to ASCE/SEI 7 and provides useful explanations and guidance on implementation

Part 3: Resource Papers

Introduce new technologies, procedures, and systems for use by design professionals on a provisional basis

Slide adapted from Bonneville and Yuan (2019) SEAOC presentation



FEMA



Building Seismic
Safety Council



Resources to Support the 2020 NEHRP Provisions and ASCE/SEI 7-22

2020 NEHRP Recommended Seismic Provisions: Design Examples, Training Materials, and Design Flow Charts

FEMA P-2192-V1/November 2021

Volume I: Design Examples

FEMA

Design Examples

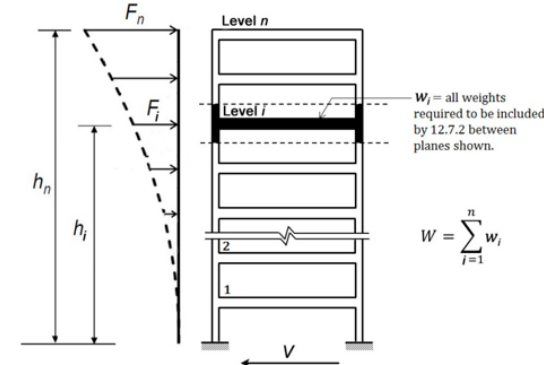

Training Materials

Chapter 8 Nonstructural Components: Fundamentals and Design Examples

2020 NEHRP Provisions Training Materials

Bret Lizundia, S.E., Rutherford + Chekene

FEMA

Building Seismic Safety Council | BSSC |

BSSC NEHRP WEBINAR SERIES

www.nibs.org/events/nehrp-webinar-series

Design Flow Charts

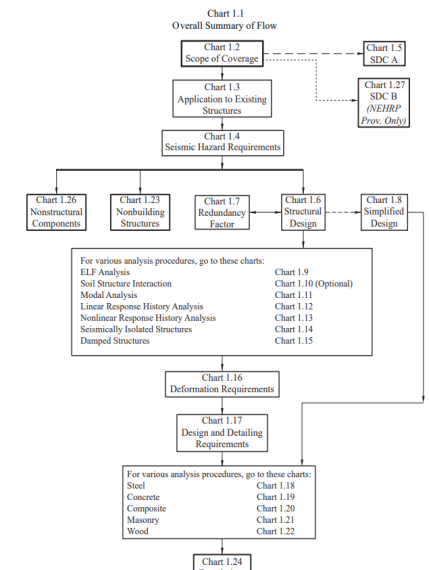

Slide adapted from Yuan (2021)
SEAONC presentation



FEMA

Building Seismic Safety Council



Evolution of Earthquake Engineering

Recent North American Earthquakes and Subsequent Code Changes

1906 San Francisco EQ

- Good steel frame infill performance

1923 Tokyo and 1925 Santa Barbara EQs

- Seismic recording instruments
- Shake tables
- Committees to create seismic code provisions
- 1927 UBC

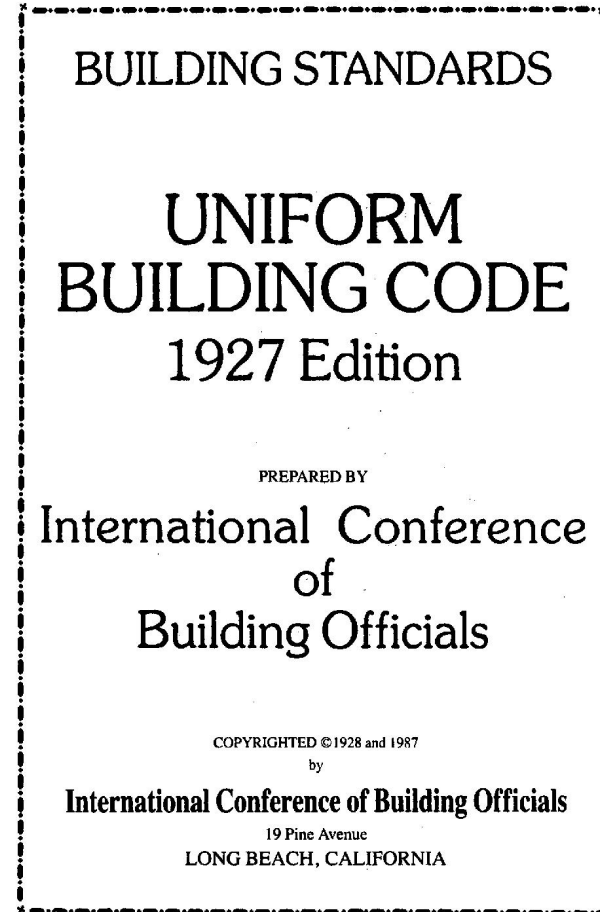

FEMA

 Building Seismic Safety Council



Recent North American Earthquakes and Subsequent Code Changes

1933 Long Beach EQ

- Ban on URM
- Field Act for schools

1951:

- Proceedings – Separate No. 66 (ASCE)

1959

- First SEAOC Blue Book



URM Bearing Wall Damage in the 1933 Long Beach EQ
(from FEMA P-2156 and Los Angeles County Library)



FEMA

 Building Seismic
Safety Council



Recent North American Earthquakes and Subsequent Code Changes

1964 Anchorage EQ

- Reinforced concrete detailing

1971 San Fernando EQ

- Reinforced concrete detailing
- Anchorage of concrete and masonry walls to diaphragms
- ATC-3-06



Excessive Drift at the Soft Ground Story of the Olive View Hospital in the 1971 San Fernando EQ
(from FEMA P-2156 and William Godden, NISEE-PEER)



FEMA



Building Seismic
Safety Council



Recent North American Earthquakes and Subsequent Code Changes

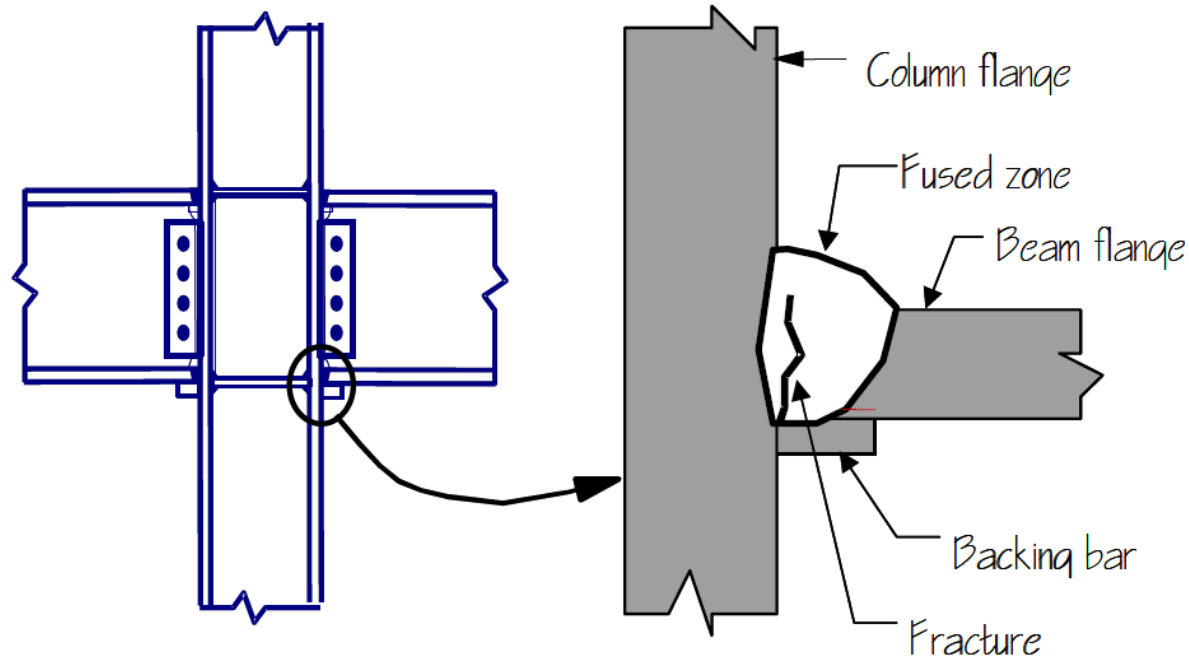

Common Location of Fracture Initiation in Pre-Northridge Steel Moment Frame Beam-to-Column Connections
(from FEMA 350)

Earthquake	UBC Edition	Enhancement
1971 San Fernando	1973	<ul style="list-style-type: none"> Direct positive anchorage of masonry and concrete walls to diaphragms
	1976	<ul style="list-style-type: none"> Seismic Zone 4, with increased base shear requirements Occupancy Importance Factor, I, for certain buildings Interconnection of individual column foundations Special inspection requirements
1979 Imperial Valley	1985	<ul style="list-style-type: none"> Diaphragm continuity ties
1985 Mexico City	1988	<ul style="list-style-type: none"> Requirements for columns supporting discontinuous walls Separation of buildings to avoid pounding Design of steel columns for maximum axial forces Restrictions for irregular structures Ductile detailing of perimeter frames
1987 Whittier Narrows	1991	<ul style="list-style-type: none"> Revisions to site coefficients Revisions to spectral shape Increased wall anchorage forces for flexible diaphragm buildings
1989 Loma Prieta	1991	<ul style="list-style-type: none"> Increased restrictions on chevron-braced frames Limitations on b/t ratios for braced frames
	1995	<ul style="list-style-type: none"> Ductile detailing of piles
1994 Northridge	1997	<ul style="list-style-type: none"> Restrictions on use of battered piles Requirements to consider liquefaction Near-fault zones and corresponding base shear requirements Revised base shear equations using $1/T$ spectral shape Redundancy requirements Design of collectors for overstrength Increase in wall anchorage requirements More realistic evaluation of design drift Steel moment connection verification by test



FEMA

Building Seismic Safety Council



History and Role of the *NEHRP Provisions*

U.S. Seismic Code Development and Role of the *NEHRP Provisions*

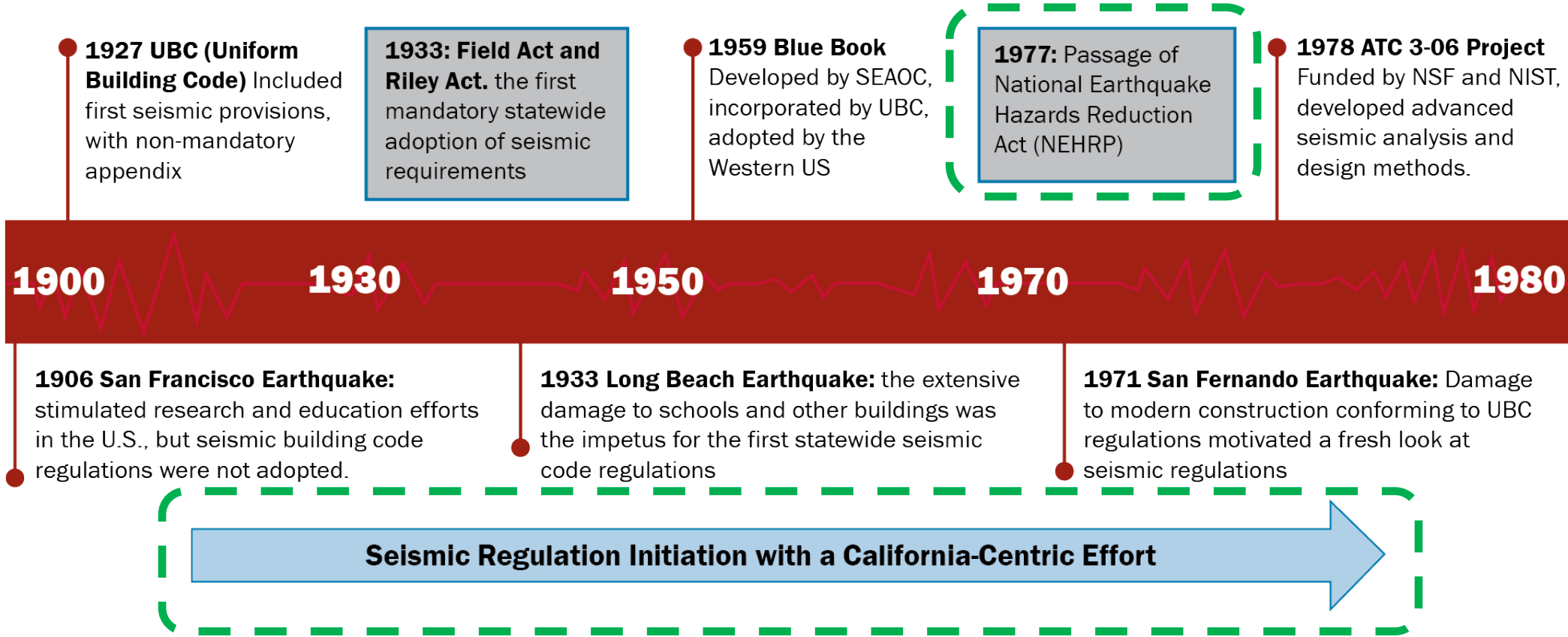

From FEMA P-2156



FEMA

Building Seismic Safety Council



U.S. Seismic Code Development and Role of the *NEHRP Provisions*

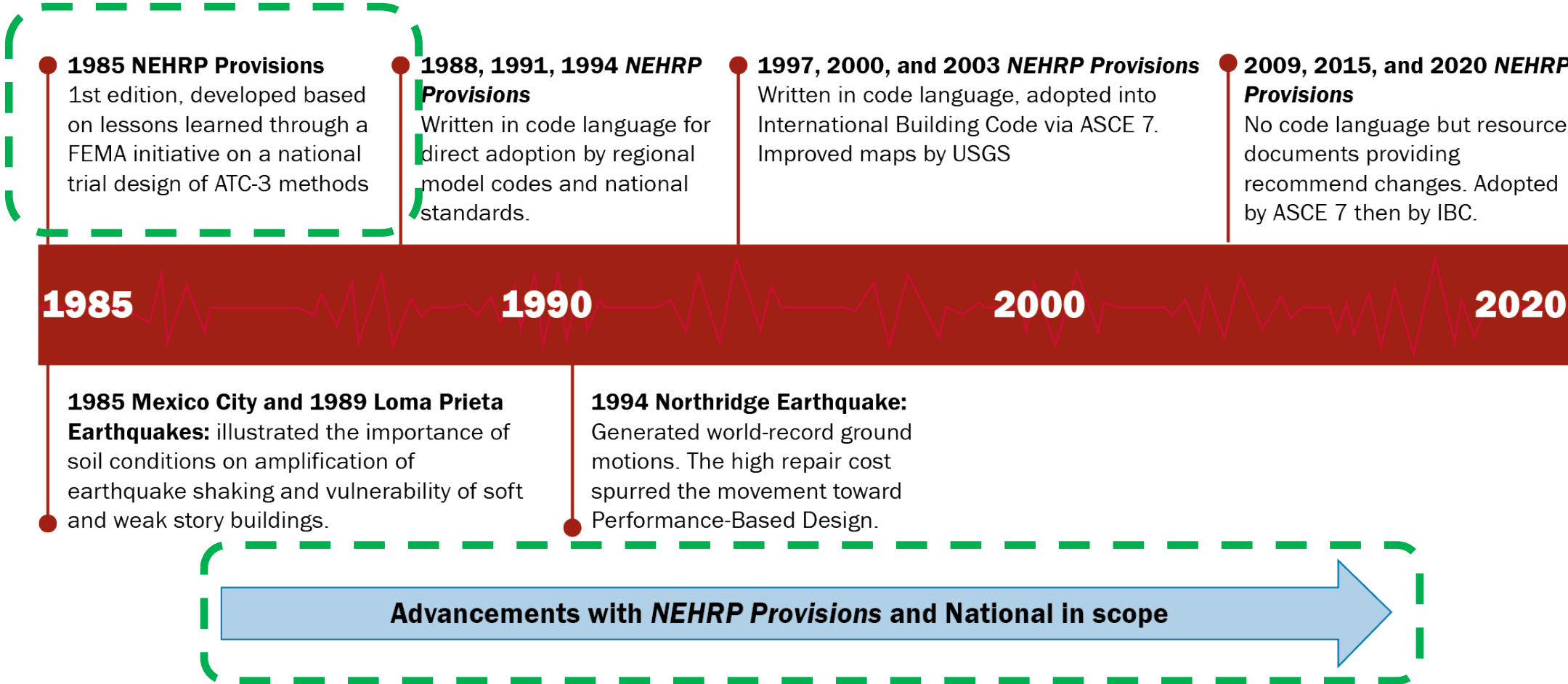

From FEMA P-2156



FEMA



Evolution of the NEHRP Provisions



FEMA

Building Seismic Safety Council



From FEMA P-2156

**Highlights of Major Changes in the
2020 *NEHRP Provisions* and in *ASCE/SEI 7-22***

Highlights of Major Changes to 2020 *NEHRP Provisions* and *ASCE/SEI 7-22*

- Updated earthquake design ground motions, site classes, and determination of spectral acceleration parameters
- Addition of three new shear wall seismic force-resisting systems
- Addition of provisions and alternative procedures for diaphragm design
- Relaxed modal response spectrum analysis requirements
- Revisions in configuration irregularity requirements
- Revisions in displacement requirements
- Changes in the nonbuilding structures provisions
- Addition of quantitative reliability targets for individual members and essential facilities
- A Part 3 paper on how to apply the *NEHRP Provisions* for improved seismic resiliency
- A Part 3 paper on a new approach to seismic lateral earth pressures
- Soil-structure interaction provision definitions for different types of shear wave velocities were clarified
- Significant update of the nonstructural components chapter and the forces used for design



FEMA

 Building Seismic
Safety Council



Move from Two-Point Spectra (2PRS) to Multi-Point Spectra (MPRS)

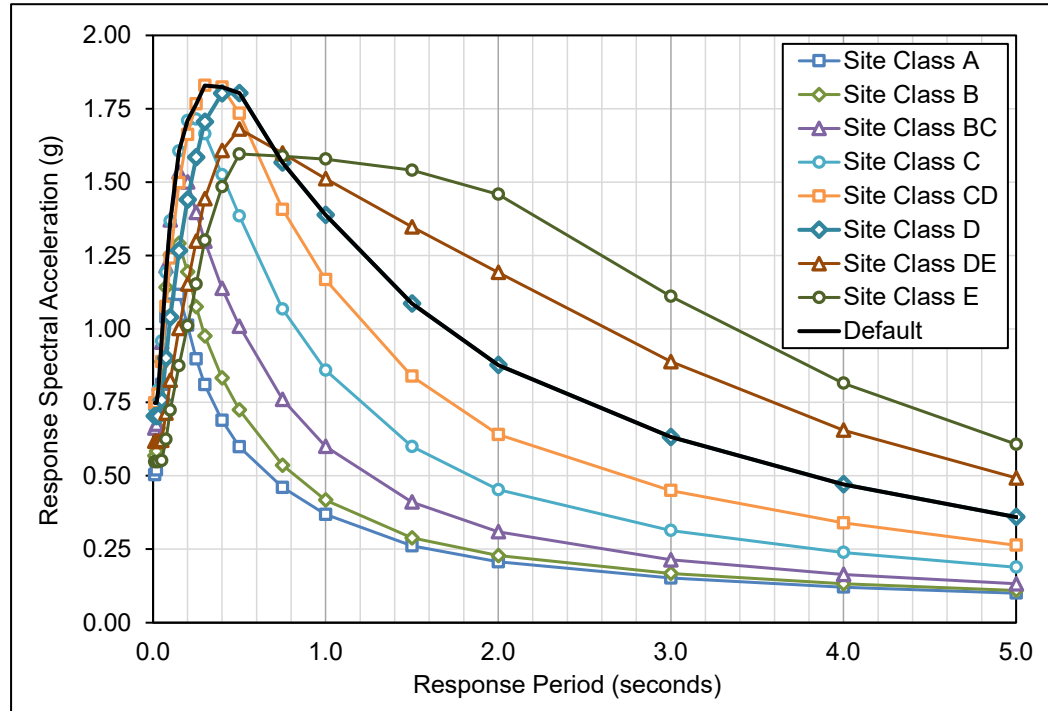

Example MPRS from ASCE/SEI 7-22
Table 21.2-1 (from 2020 NEHRP
Training Materials by C. Kircher)

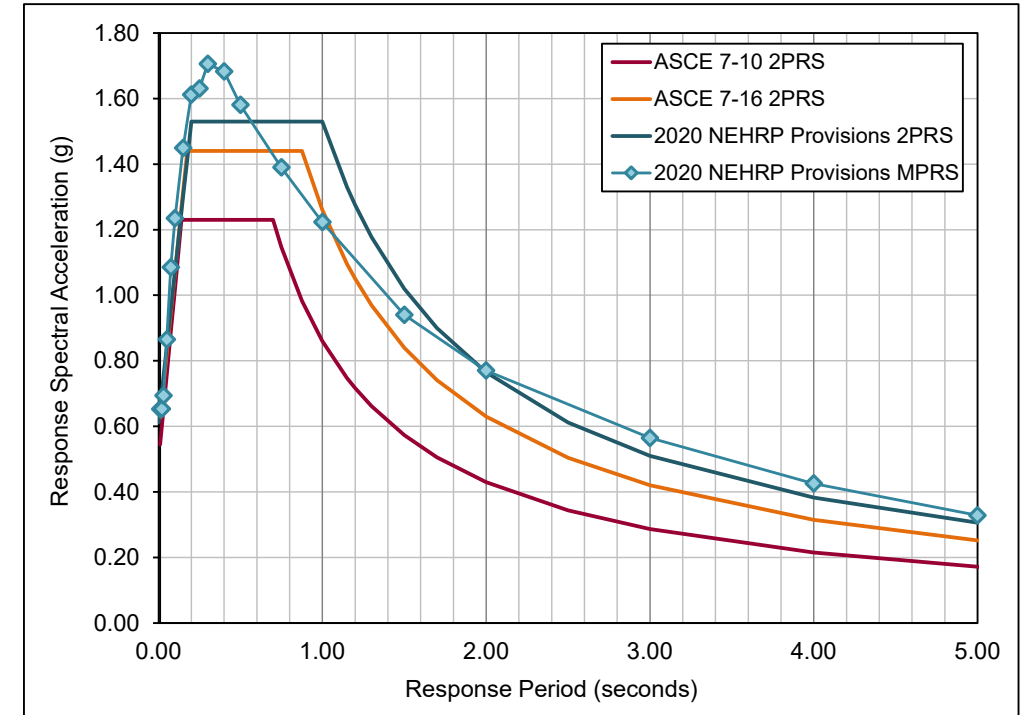

San Mateo, CA for default
soil class (from FEMA
P-2078, Figure 8.2-2)

Velocity domain of the ASCE 7-16 (2PRS) design spectrum includes the 1.5 multiplier of the applicable Section 11.4.8 exception.



FEMA

Building Seismic
Safety Council



Three New Shear Wall Seismic Force-Resisting Systems



(a)



(b)



(c)

Figure 6. The three new seismic force-resisting systems that now have detailed requirements in the 2020 *NEHRP Recommended Seismic Provisions*: (a) reinforced concrete ductile coupled walls, (source: MKA); (b) steel and concrete coupled composite plate shear walls (Source: MKA); and (c) cross-laminated timber shear wall (Source: Lendlease).



FEMA

Building Seismic
Safety Council



From FEMA P-2156

Updates to Diaphragm Design Provisions

- ASCE/SEI 7-10
 - Sections 12.10.1 and 12.10.2 - *Traditional Diaphragm Design Method*

- ASCE/SEI 7-16 (2015 NEHRP Provisions)
 - Section 12.10.3 - *Alternative Design Provisions* is added
 - Cast-in-place concrete, precast concrete, and wood structural panel diaphragms

- ASCE/SEI 7-22 (2020 NEHRP Provisions)
 - Section 12.10.3 - *Alternative Design Provisions* is expanded
 - Bare steel deck, concrete-filled steel deck diaphragms
 - Section 12.10.4 - *Alternative RWFD Provisions* is added



FEMA

 Building Seismic Safety Council



Relaxation in Requirement for Response Spectrum Analysis

2015 NEHRP Provisions and ASCE/SEI 7-16



2020 NEHRP Provisions and ASCE/SEI 7-22

Table 12.6-1 Permitted Analytical Procedures

Seismic Design Category	Structural Characteristics	Equivalent Lateral Force Analysis, Section 12.8 ^a	Modal Response Spectrum Analysis, Section 12.9, and Modal Response History Analysis, Section 12.10 ^a	Seismic Response History Procedures, Chapter 16 ^a
B, C	All structures	P	P	P
D, E, F	Risk Category I or II buildings not exceeding 2 stories above the base	P	P	P
D, E, F	Structures of light frame construction	P	P	P
D, E, F	Structures with no structural irregularities and not exceeding 160 ft. in structural height	P	P	P
D, E, F	Structures exceeding 160 ft. in structural height with no structural irregularities and with $T_s \leq 3.5T_s$	P	P	P
D, E, F	Structures not exceeding 160 ft. in structural height and having only horizontal irregularities of Type 2, 3, 4, or 5 in Table 12.3-1 or vertical irregularities of Type 4, 5a, or 5b in Table 12.3-2	P	P	P
D, E, F	All other structures	NP	P	P

^aP: Permitted; NP: Not Permitted; $T_s = S_{D1}/S_{D5}$.

Replace Section 12.6 with the following (delete Table 12.6-1 Permitted Analytical Procedures):

The structural analysis required by Chapter 12 shall be completed in accordance with the requirements of (a) Equivalent Lateral Force Procedure of Section 12. 8, (b) Modal Response Spectrum Analysis of Section 12.9.1, (c) Linear Response History Analysis of Section 12.9.2, or (d) with an analysis approved by the authority having jurisdiction. Nonlinear Response History Procedure requirements are given in Chapter 16.



Revisions in Displacement Requirements

- Definitions and graphics developed to include diaphragm deformation in displacements related to deformation compatibility, structural separation, and at members spanning between structures.
- Increase in drift used to check deformation compatibility.
- Part 3 resource paper on issues and available research on whether to amplify drifts by C_d or R .

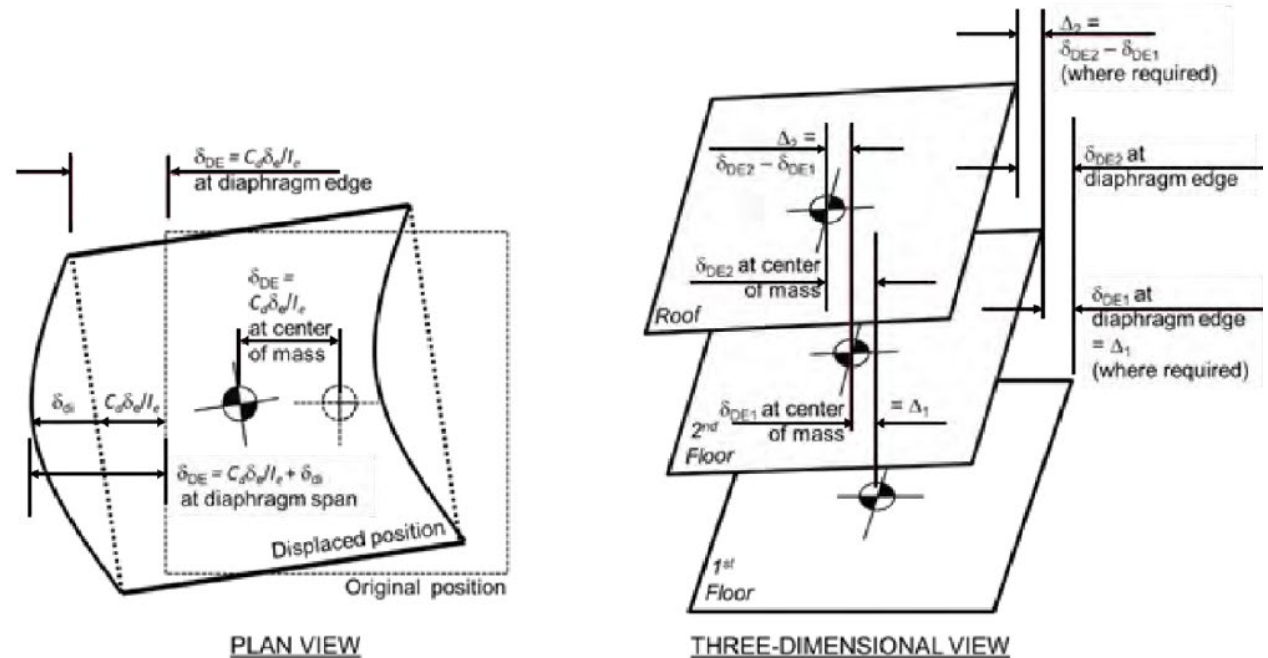

Design Earthquake displacement and design story drift
(from FEMA P-2082-1, Figure C12-8.1)

Changes in Nonbuilding Structures Requirements

- New Section 15.2: Addresses coupled systems
- Revised Section 15.3.1: For nonbuilding structures supported by other structures, when the ratio of the nonbuilding structure weight to the nonbuilding structure + supporting structure is below a threshold value, use Chapter 13. When above threshold, use Chapter 15.
 - ASCE/SEI 7-16: Threshold is 25%
 - ASCE/SEI 7-22: Revised to 20%, based on review of research
- New Section 15.7.7.4: Provisions for design of corrugated steel tanks added.

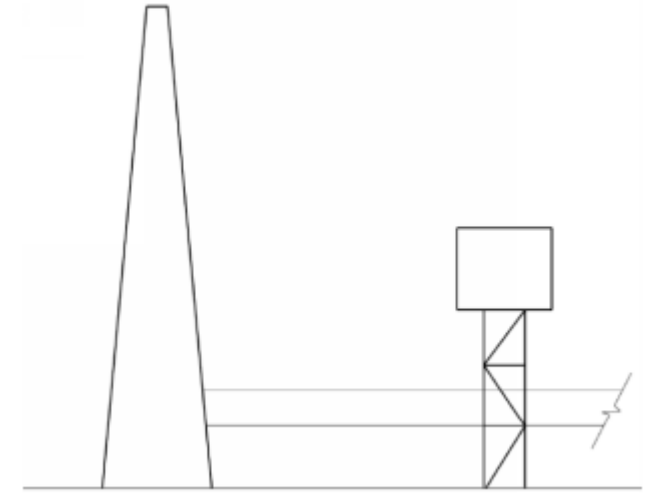

Coupled Analysis Example
Stack connected to a tower by
a large duct (Figure C15-2-1 in
2020 NEHRP Provisions)

Addition of Quantitative Reliability Targets for Individual Members and Essential Facilities

- Section 1.1.1 of 2020 *NEHRP Provisions* adds individual member/connection reliability targets to previously available building collapse reliability targets.
- Section 2.1.5 of 2020 *NEHRP Provisions* states:
“A desired target reliability for Risk Category IV buildings and nonbuilding structures is for there to be a 10% probability of loss of essential function given the Design Earthquake ground motion.”

Risk Category ¹	Probability of Collapse	
	Given MCE _R Shaking	In 50 years*
I	**	**
II	10%	1%
III	5%	less than 1%
IV	2.5%	less than 1%

Risk Category ¹	Conditional Probability of Failure for Member or Connection	
	Given DE Shaking	Given MCE _R Shaking
I	**	**
II	10%	25%
III	5%	15%
IV	2.5%	9%

From FEMA P-2082-1



FEMA



Part 3 Paper on a New Approach to Seismic Lateral Earth Pressures

- Classical methods (Mononobe-Okabe) assume the seismic earth pressures are related to acceleration.
- They are actually related to relative displacement between the soil and the wall.
- Soil-structure interaction theory and research can be used to relate kinematic interaction and inertial interaction to wall demands.
- The Part 3 paper provides a simplified method and example.

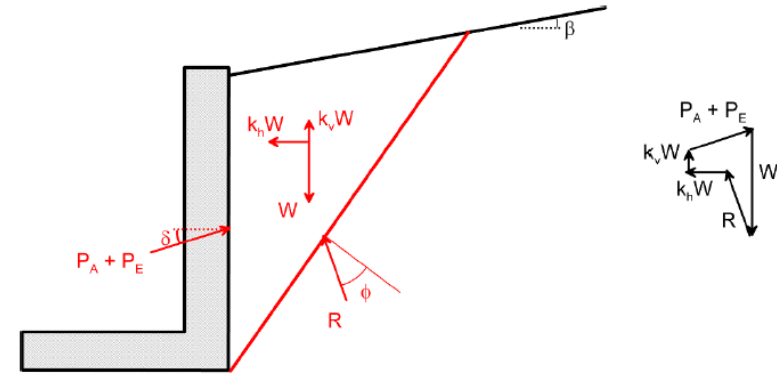

Classical method free-body diagram

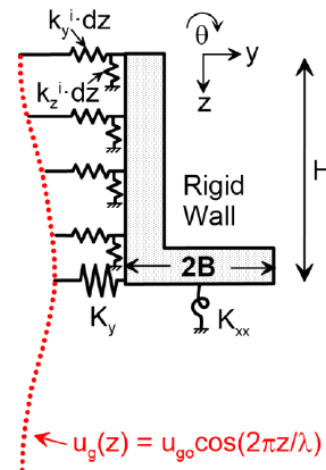

Kinematic interaction

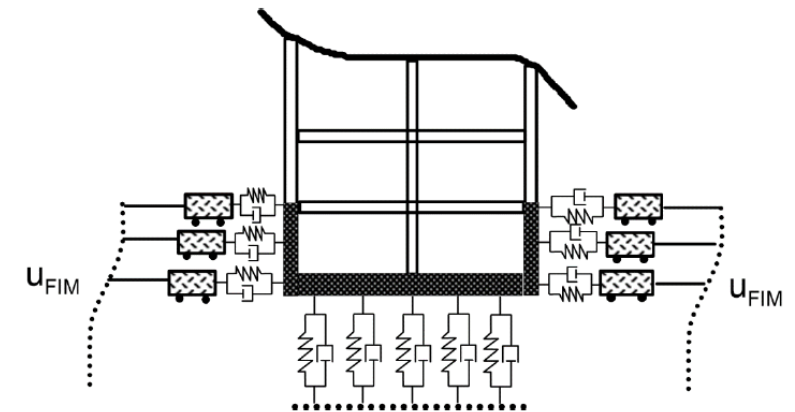

Inertial interaction

New Seismic Design Force Equation

ASCE 7-16

$$\frac{F_p}{W_p} = (0.4S_{DS}) \times \left[1 + 2 \left(\frac{z}{h} \right) \right] \times \left[\frac{a_p}{R_p} \right] \times I_p$$

 Ground response

 Peak floor acceleration/PGA

 Resonance and component ductility

2020 NEHRP Provisions and ASCE 7-22

$$\frac{F_p}{W_p} = (0.4S_{DS}) \times \left[\frac{H_f}{R_\mu} \right] \times \left[\frac{C_{AR}}{R_{po}} \right] \times I_p$$

 Component strength reserve margin

 Building ductility



FEMA



Building Seismic
Safety Council



Building Modal Periods, $T_{n,bldg}$

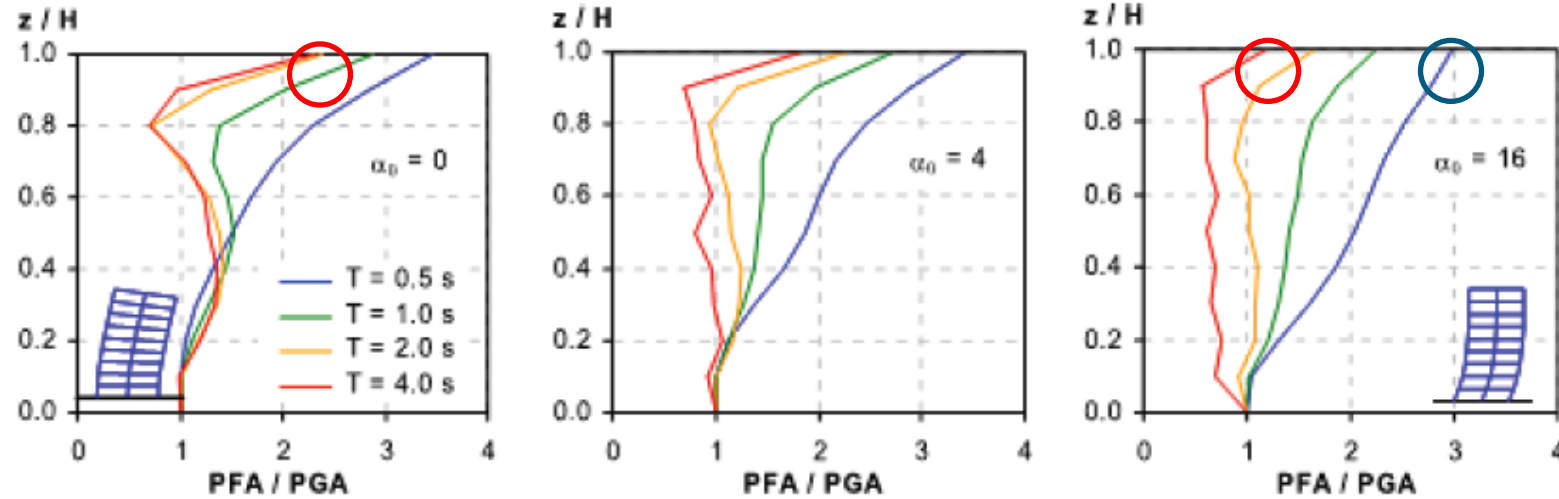

Key Takeaway

- Longer period means less amplification
- Cantilever systems have more “whipping” action

Effect of period of vibration and lateral system stiffness on PFA/PGA

α_0 = Lateral stiffness ratio, defined as $\alpha_0 = H/(GA/EI)^{0.5}$

H = height,

GA = shear rigidity of a shear beam

EI = the flexural stiffness

$\alpha_0 = 0$ represents a pure flexural model

α_0 approaching infinity represents a pure shear beam
(from Miranda and Taghavi, 2009)



FEMA

Building Seismic
Safety Council



Note: Full reference citations are in NIST
GCR 18-917-43.

PFA/PGA (H_f) Amplification Factor

$$H_f = 1 + a_1 \left(\frac{z}{h}\right) + a_2 \left(\frac{z}{h}\right)^{10}$$

or:

$$H_f = 1 + 2.5 \left(\frac{z}{h}\right)$$

where:

$$a_1 = \frac{1}{T_a} \leq 2.5$$

$$a_2 = [1 - (0.4/T_a)^2] \geq 0$$

$$T_a = C_t h_n^x$$

$$\frac{F_p}{W_p} = (0.4S_{DS}) \times \left[\frac{H_f}{R_\mu}\right] \times \left[\frac{C_{AR}}{R_{po}}\right] \times I_p$$

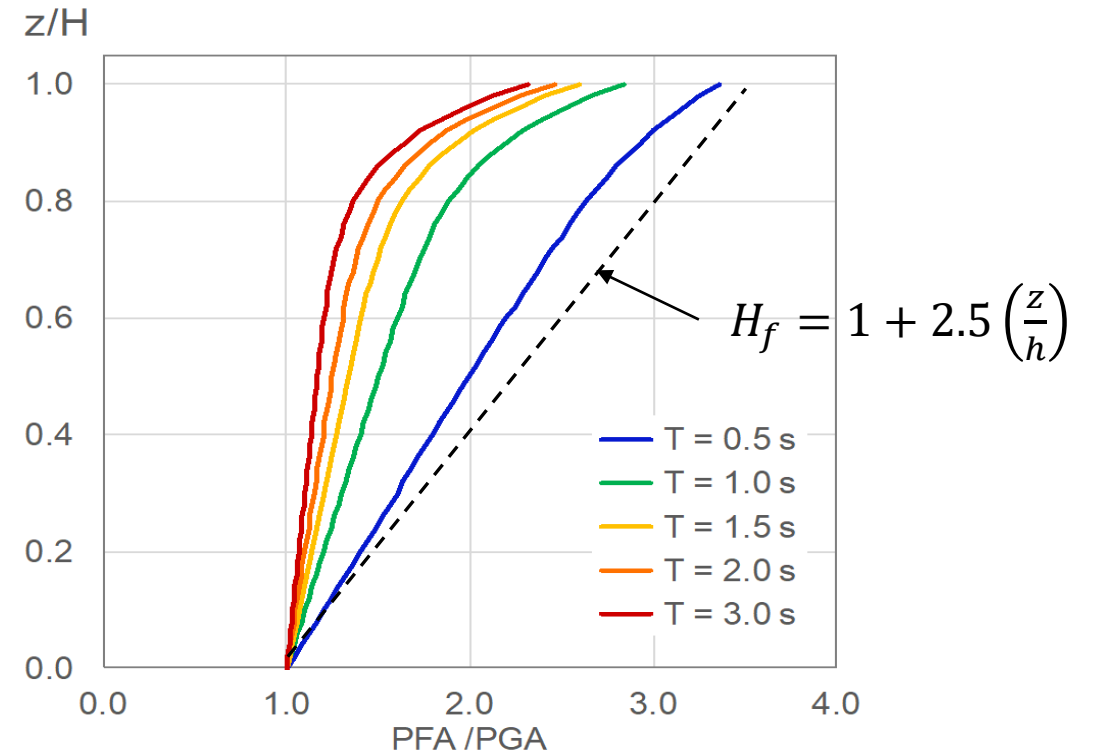

FEMA



Building Seismic
Safety Council



Seismic Force-Resisting System

$$T_{comp} = 0.5 \text{ sec}$$

Reinforced Concrete SW

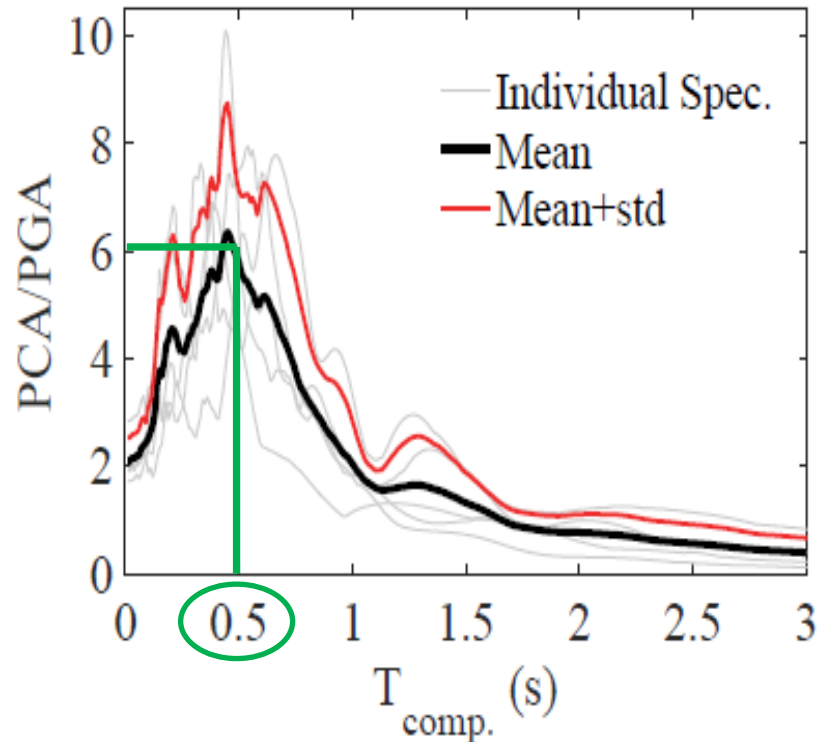

Steel SMRF

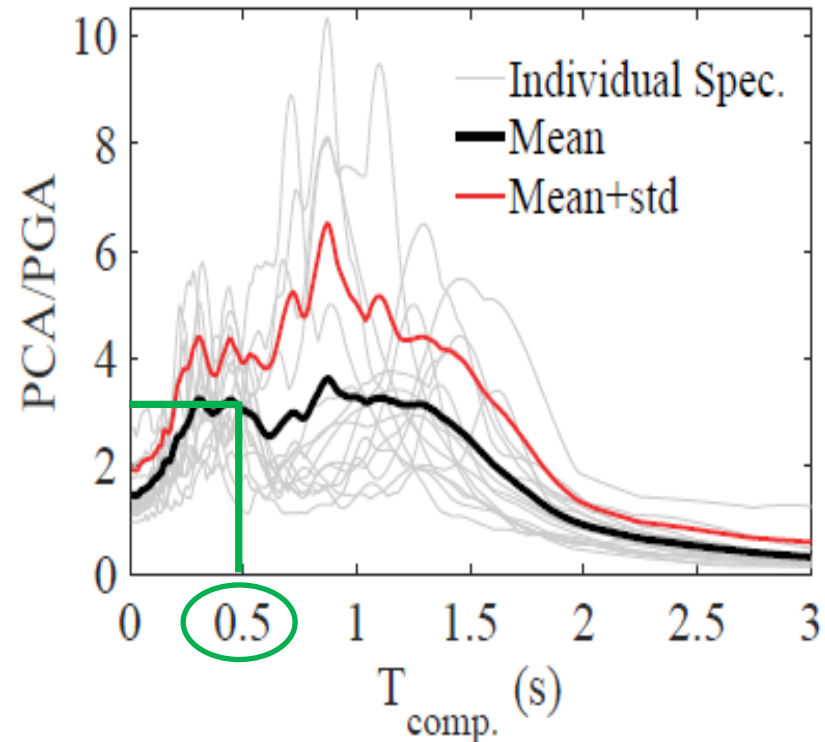

Effect of building stiffness on PCA/PGA for instrumental recordings
(from NIST GCR 18-917-43, 2018 and
Lizundia paper in 2019 SEAOC Convention Proceedings)

Key Takeaway

- Same component responds very differently in different seismic force-resisting systems

Figure Assumptions

- Elastic component assumed with $\beta_{comp} = 5\%$
- Dataset includes 19 recordings with $PGA > 0.15g$



FEMA

Building Seismic Safety Council



Building Ductility, R_μ

$$R_\mu = (1.1 R / (I_e \Omega_0))^{1/2} \geq 1.3$$

$$\frac{F_p}{W_p} = (0.4 S_{DS}) \times \left[\frac{H_f}{R_\mu} \right] \times \left[\frac{C_{AR}}{R_{po}} \right] \times I_p$$

where:

R = Response modification factor for the building or nonbuilding structure

I_e = Importance Factor for the building or nonbuilding structure

Ω_0 = Overstrength factor for the building or nonbuilding structure

For components at or below grade, R_μ shall be taken as 1.0.



FEMA



Building Seismic
Safety Council



Chapter 13: Other Significant Changes from ASCE/SEI 7-16 to ASCE/SEI 7-22

- Three different types of supports defined (Section 11.2) and design of supports depends on their system not components they support (Section 13.5.4.6,7)

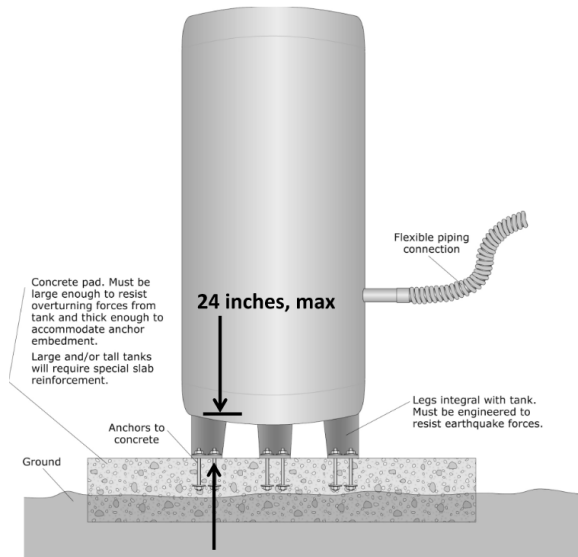

Nonstructural component with integral equipment supports

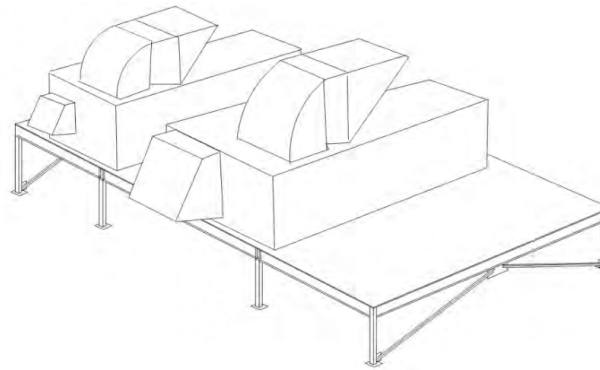

Equipment support platform supporting two mechanical components

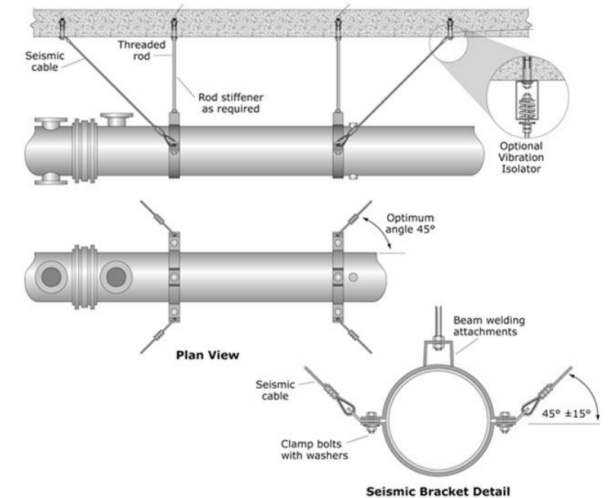

Distribution system support for piping

Images from FEMA P-2082-1 (2020) and FEMA E-74

Chapter 13: Other Significant Changes from ASCE/SEI 7-16 to ASCE/SEI 7-22

- Seismic design force provision using nonlinear response history analysis is updated; other dynamic analysis methods are removed (Section 13.3.1.5).
- Ω_{op} is required to increase the load effects for anchors in concrete or masonry, instead of Ω_0 (Section 13.4.2).
- Architectural component list is expanded, and items account for updated coefficient for seismic design: C_{AR} , R_{po} , and Ω_{op} (Table 13.5-1).
Example: Partitions split into short light frame, tall light frame, reinforced masonry and other
- Mechanical and electrical component list is expanded, and items account for updated coefficient for seismic design: C_{AR} , R_{po} , and Ω_{op} (Table 13.6-1).



FEMA

 Building Seismic Safety Council



Chapter 13: Other Significant Changes from ASCE/SEI 7-16 to ASCE/SEI 7-22

- Detailed scope of design criteria for nonstructural components (Section 13.1)
- Explicit load combinations for nonstructural components now provided (Section 13.2.2)
- Required analysis for condition where the nonstructural component weight is equal to or greater than 20% the combined effective seismic weight, W (Section 13.2.9)
- Penthouse and rooftop structure requirements are added (Section 13.5.11).
 - Seismic force-resisting system to conform to one in Table 12.2-1, Table 15.4-1, or new coefficients in Table 13.5-1

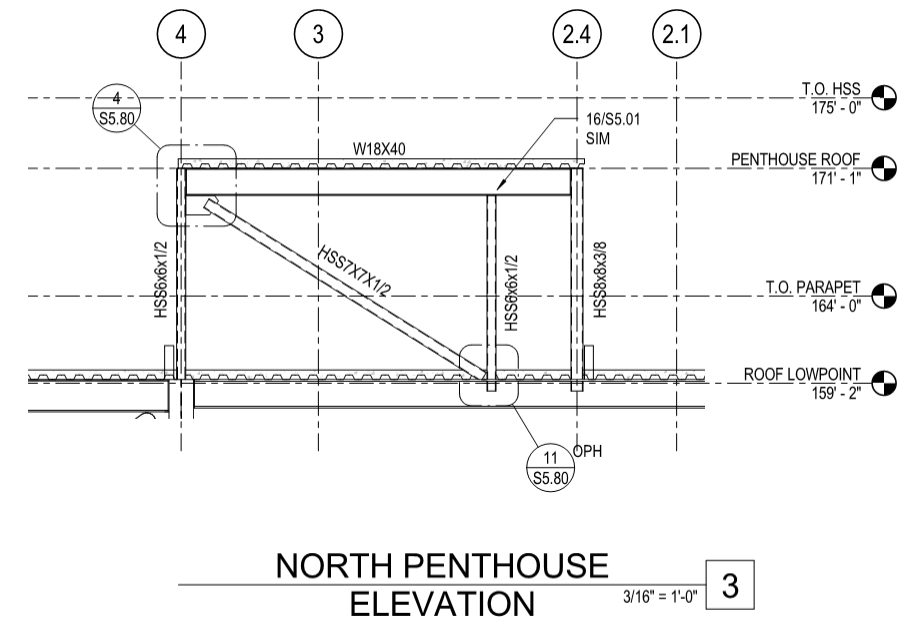

Questions?



FEMA



Building Seismic
Safety Council



Overview of Design Example Chapters

Chapter 2 (Section 2.1 to 2.6) - Fundamentals

Chapter 2 - Fundamentals (Harris): Topics

- Fundamental Concepts
- Ground Motions and Their Effects
- Structural Dynamics of Linear SDOF Systems
- Response Spectra
- Structural Dynamics of Simple MDOF Systems
- Inelastic Behavior
- Structural Design

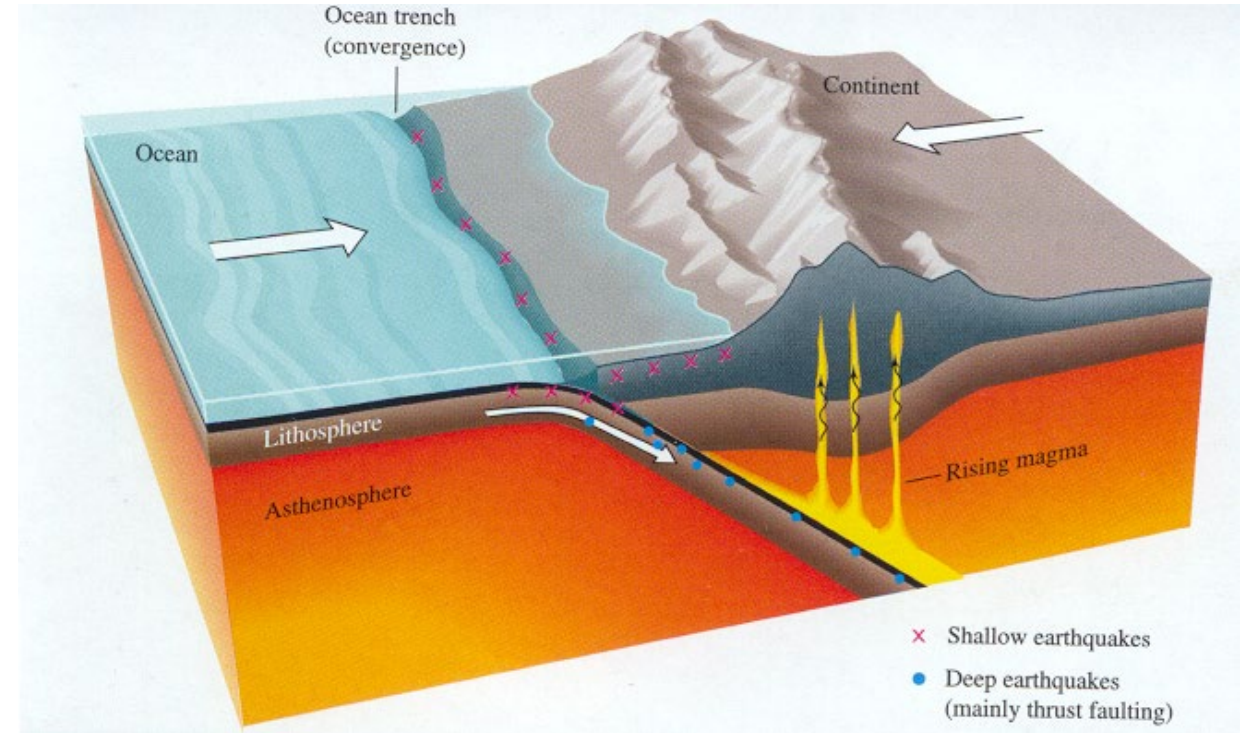

Subduction zone tectonic environment

Image from E.V. Leyendecker, USGS



FEMA

Building Seismic
Safety Council



Chapter 2 – Fundamentals: Yield, Ductility, Overstrength

First Significant Yield

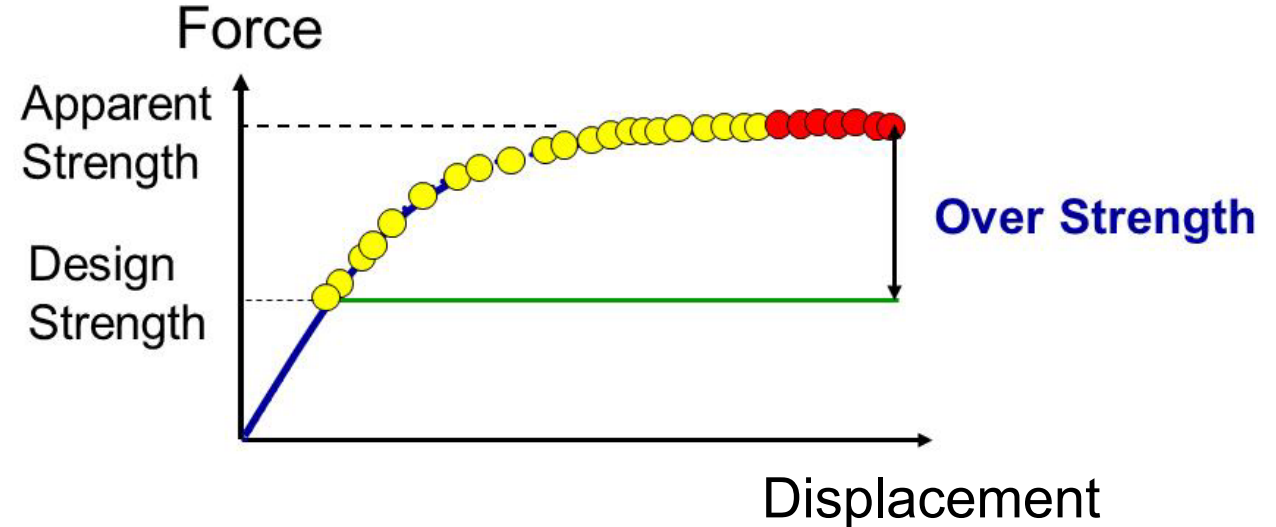
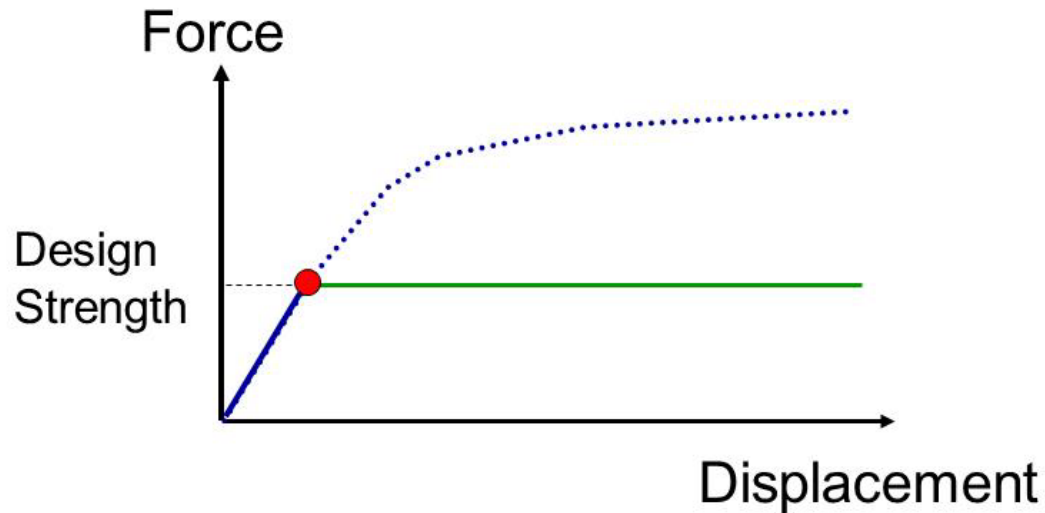
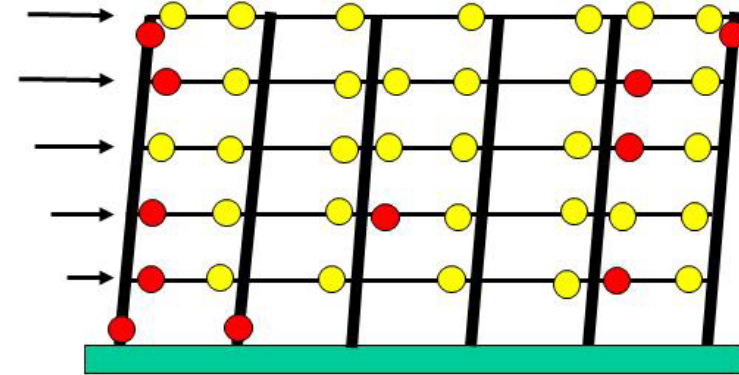
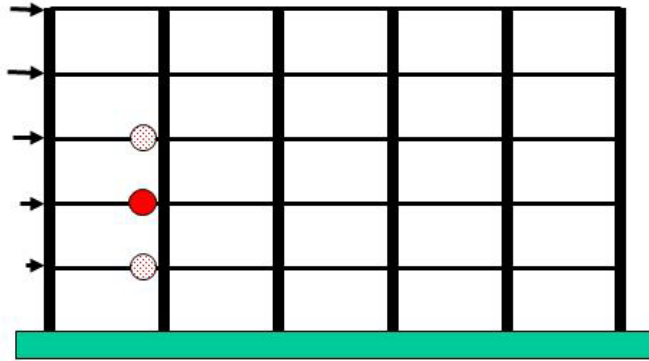

FEMA



Building Seismic Safety Council



Images from Finley Charney

Section 2.7 – Resilience-Based Design

Section 2.7 - Resilience-Based Design (Bonowitz): Topics

- Development of resilience-based earthquake design
 - 2020 *NEHRP Provisions*, Resource Paper 1
- Functional Recovery (FR)
 - Its relation to resilience
 - Its relation to current building code provisions
- Hypothetical application to the CLT Design Example
 - CLT Shear Wall Design Example is in Chapter 6
 - Discussion in terms of resilience-based design is in Section 2.7



NEHRP Recommended Seismic Provisions for New Buildings and Other Structures

Volume II: Part 3 Resource Papers
FEMA P-2082-2 / September 2020



FEMA

Building Seismic
Safety Council



Section 2.7 - The “Resilience Field”

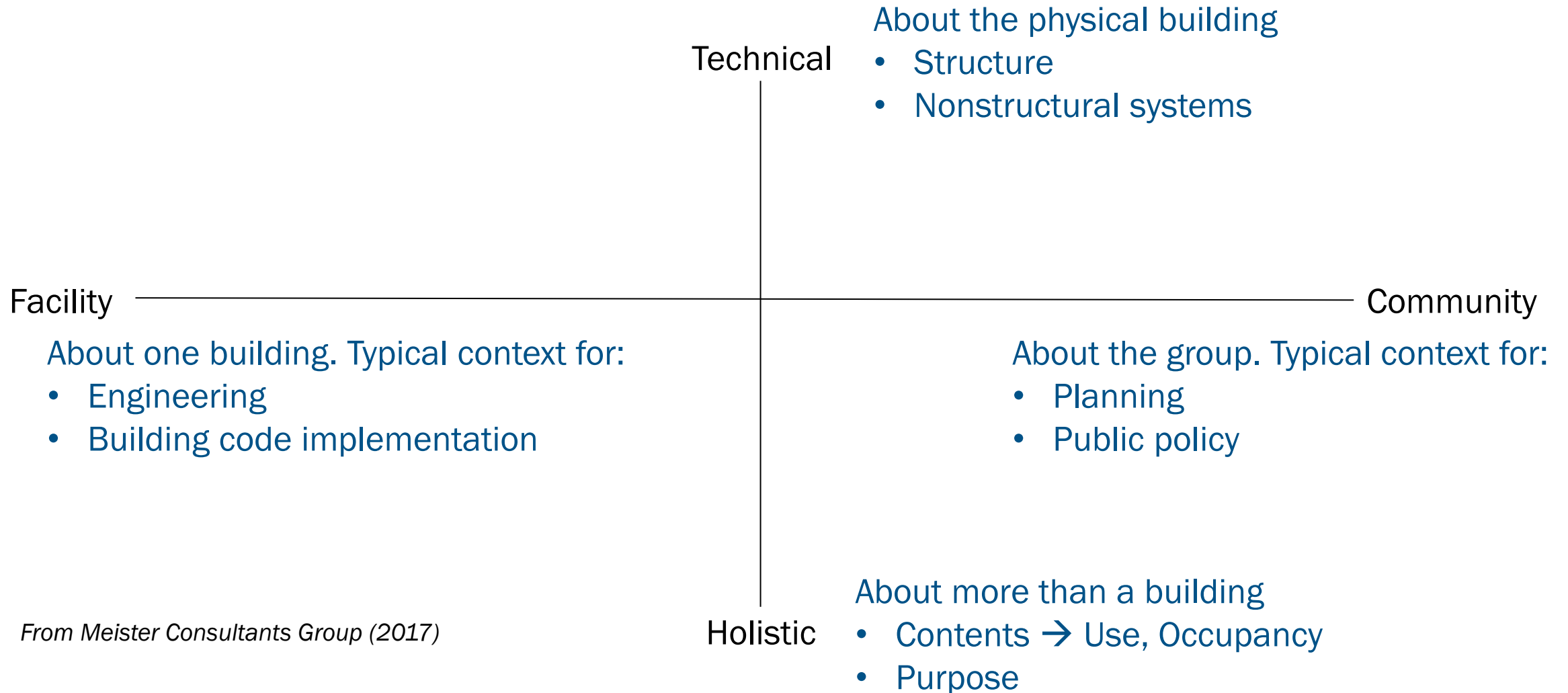

From Meister Consultants Group (2017)



FEMA



Section 2.7 - Functional Recovery vs. Community Resilience

Functional Recovery

- *NEHRP Provisions*
- ASCE/SEI 7
- IBC

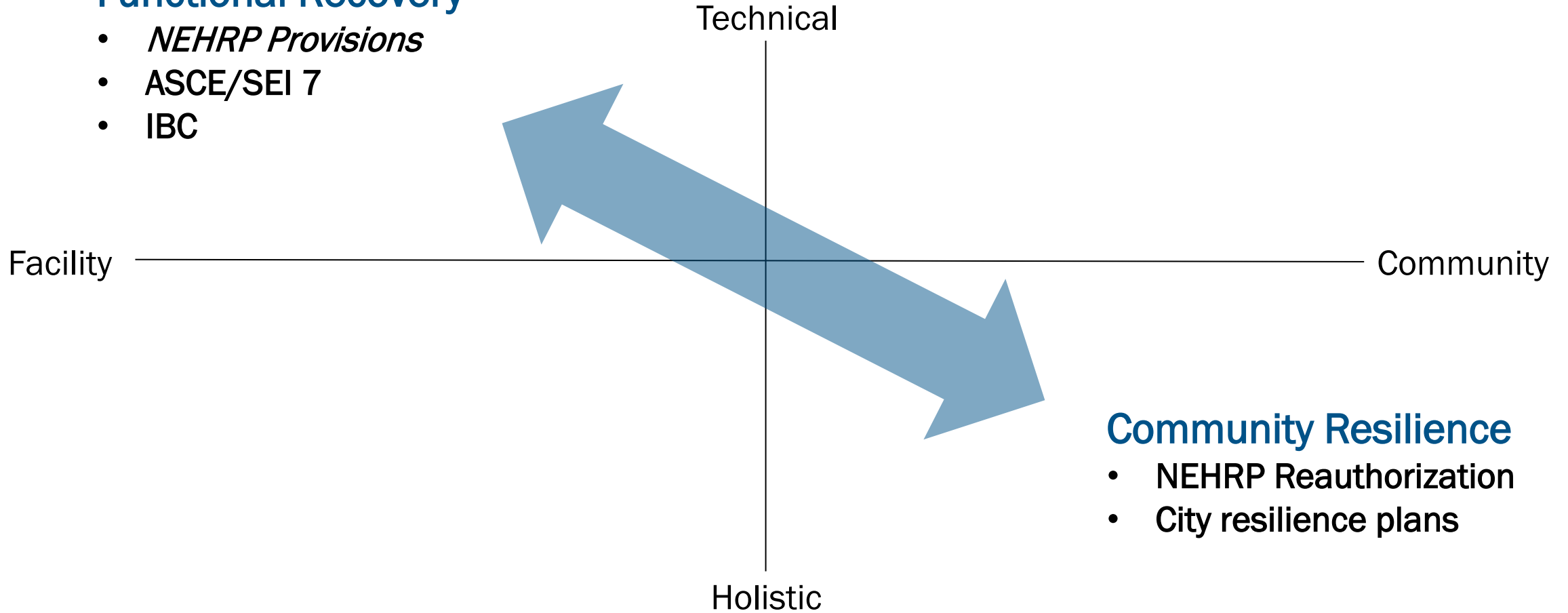

Community Resilience

- NEHRP Reauthorization
- City resilience plans



FEMA



Building Seismic
Safety Council



Section 2.7 - FEMA-NIST Definitions* for Functional Recovery

- Functional Recovery (FR) is ...
 - A post-earthquake performance state in which a building is maintained, or restored, to support the basic intended functions associated with the pre-earthquake use or occupancy.
- A Functional Recovery objective is ...
 - FR achieved within an acceptable time following a specified earthquake, where the acceptable time might differ for various building uses and occupancies.

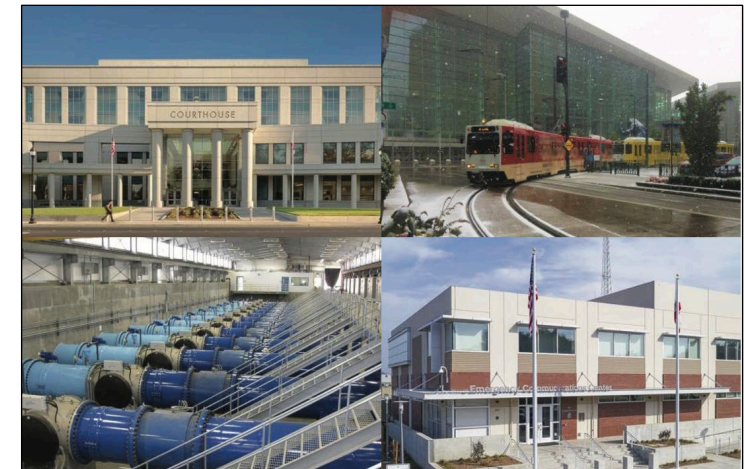

Recommended Options for Improving the Built Environment for Post-Earthquake Reoccupancy and Functional Recovery Time

FEMA P-2090 / NIST SP-1254 / January 2021



* The FEMA-NIST definitions consider infrastructure systems as well as buildings. These versions are edited to address only buildings.



FEMA

Building Seismic Safety Council



Section 2.7 - Functional Recovery and Performance-Based Engineering

- A structural safety objective may be written as: $P(\text{collapse}) < X\%$, given $2/3 * MCE_R$

- Analogously, a functional recovery objective may be written as:

$$P(T_{FR, \text{expected}} > T_{FR, \text{acceptable}}) < Y\%, \text{ given } 2/3 * MCE_R \text{ (or other specified hazard)}$$

- Open policy questions for developers of FR codes:
 - What is the acceptable or desirable FR time, $T_{FR, \text{acceptable}}$, for a given occupancy?
 - What is the appropriate confidence level, Y ?
 - What hazard level should be used for FR?
 - For this example, use $2/3 * MCE_R$ (See Resource Paper 1 and Design Example 2.7 for discussion.)



Section 2.7 - Functional Recovery Objective: CLT Design Example

Options for Functional Recovery

- Increase Seismic Importance Factor, I_e
- Reduce R -factor (but already low)
- Set a lower value for panel connector capacity
- Account for partitions
- Study expected damage and recovery time in more detail

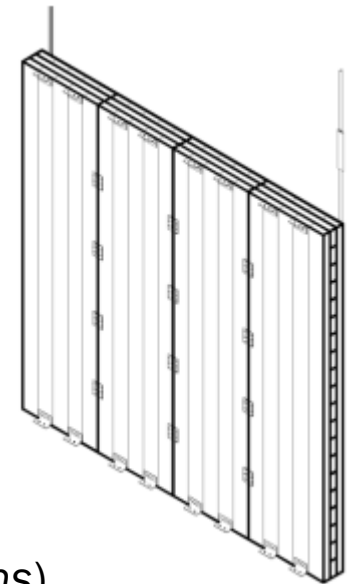
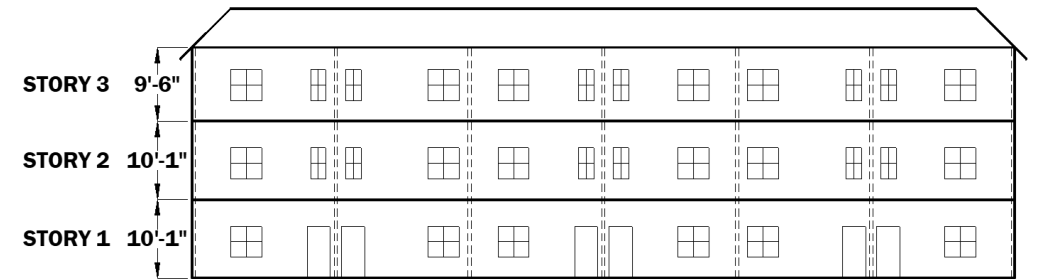

CLT shear wall
(Figure C14.5.2.1 in
2020 NEHRP Provisions)

Chapter 3 – Earthquake Ground Motions

Section 3.2 Part 1 – 2018 Update to the USGS National Seismic Hazard Model (Rezaeian): Topics

- Interplay between the USGS hazard models and the BSSC PUC requirements
- The 2018 USGS National Seismic Hazard Model (NSHM) for Conterminous U.S.
 - Ground motion models in CEUS (e.g. NGA-East)
 - Deep basin effects in WUS
- Outside of the Conterminous U.S. (HI, AK, PRVI, GNMI, AMSAM)

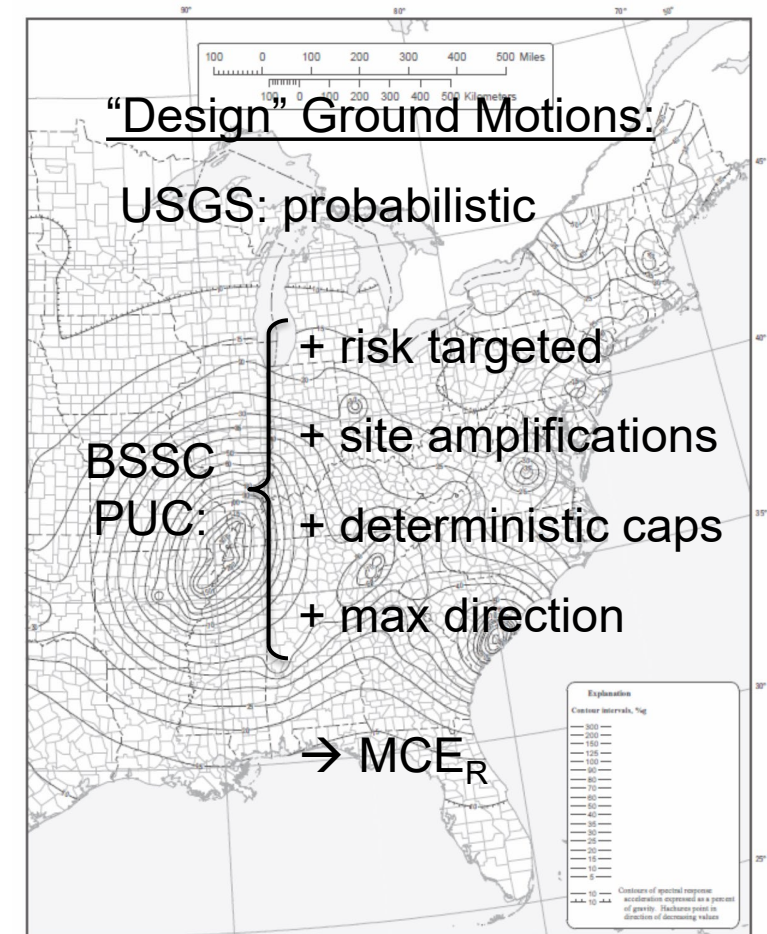

FEMA

Building Seismic Safety Council



USGS
science for a changing world

Section 3.2: USGS NSHMs and BSSC PUC Requirements

Hazard Model (PSHA)

Site-Specific Procedures of Chapter 21

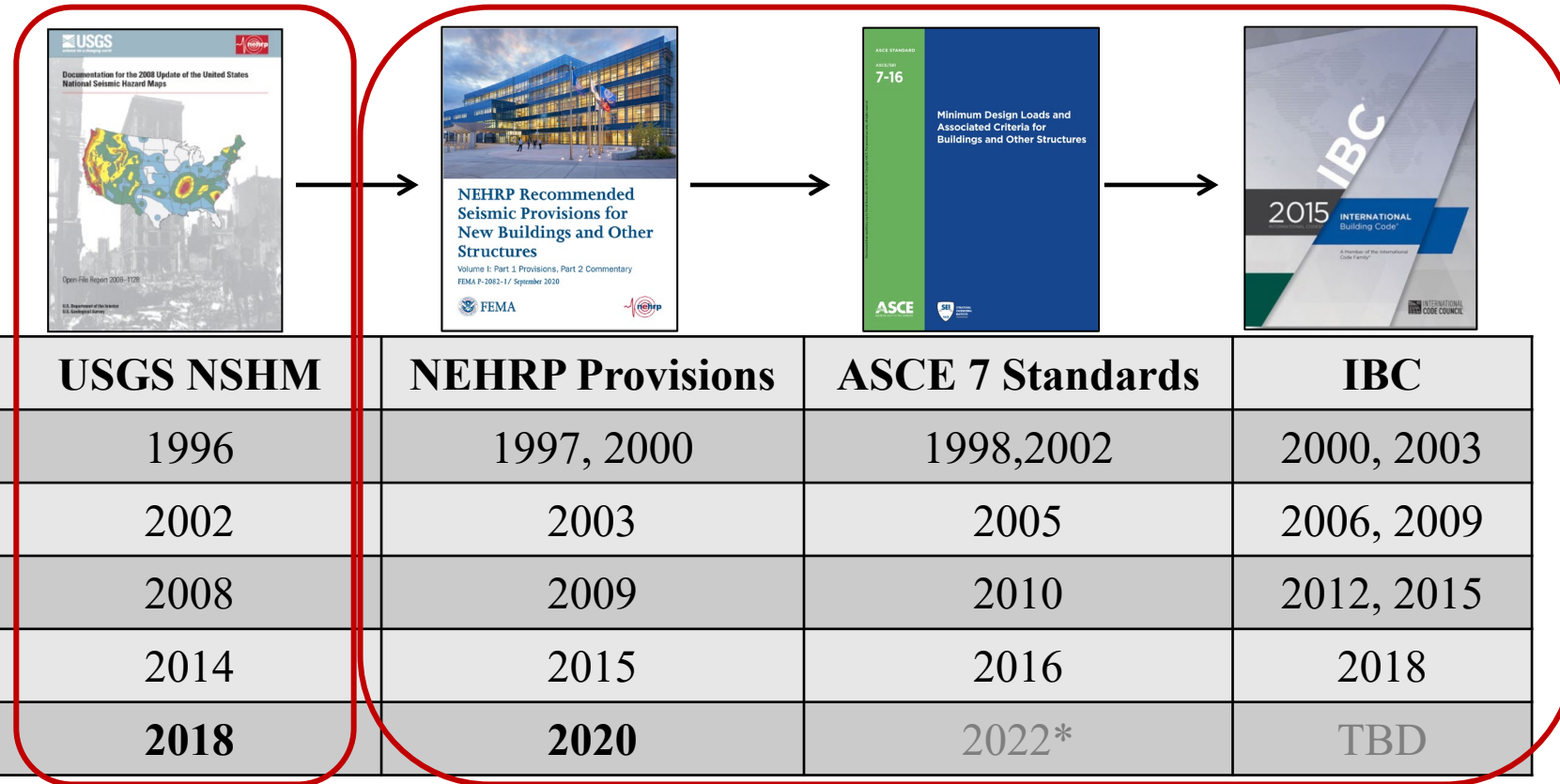

Hazard Curves+ (RiskTarget, MaxDir, ~~SiteAmpl~~, DetCaps) → “Design” Ground Motions



FEMA



Building Seismic Safety Council



Section 3.2 - Updates to 2020 NEHRP Design Ground Motions in Conterminous US

2018 USGS NSHM

1. New ground motion models (GMMs), including **NGA-East**, & amplification factors in the Central & Eastern US (CEUS)
2. Deep **basin effects** in Los Angeles, Seattle, San Francisco, and Salt Lake City regions
3. Minor modifications of GMMs (crustal & subduction) in the Western US (WUS)
4. Updating **background seismicity** to include 2013-2017 earthquakes

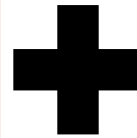

BSSC Project '17

No change to risk-targeted calcs

1. Using **multi-period multi-Vs30 response spectrum (MPRS)**
2. Modifying **deterministic caps** based on deaggregation of probabilistic hazard
3. Updating the **max-direction** factors

MPRS issue directly influenced the 2018 update of USGS NSHM (GMMs applicable for all periods and site classes)

Necessary for MPRS



FEMA

Building Seismic Safety Council



Section 3.2 - Hazard Changes (CEUS)

Ratio Maps (2018/2014):

2% in 50yr uniform hazard, BC site class (760 m/s)

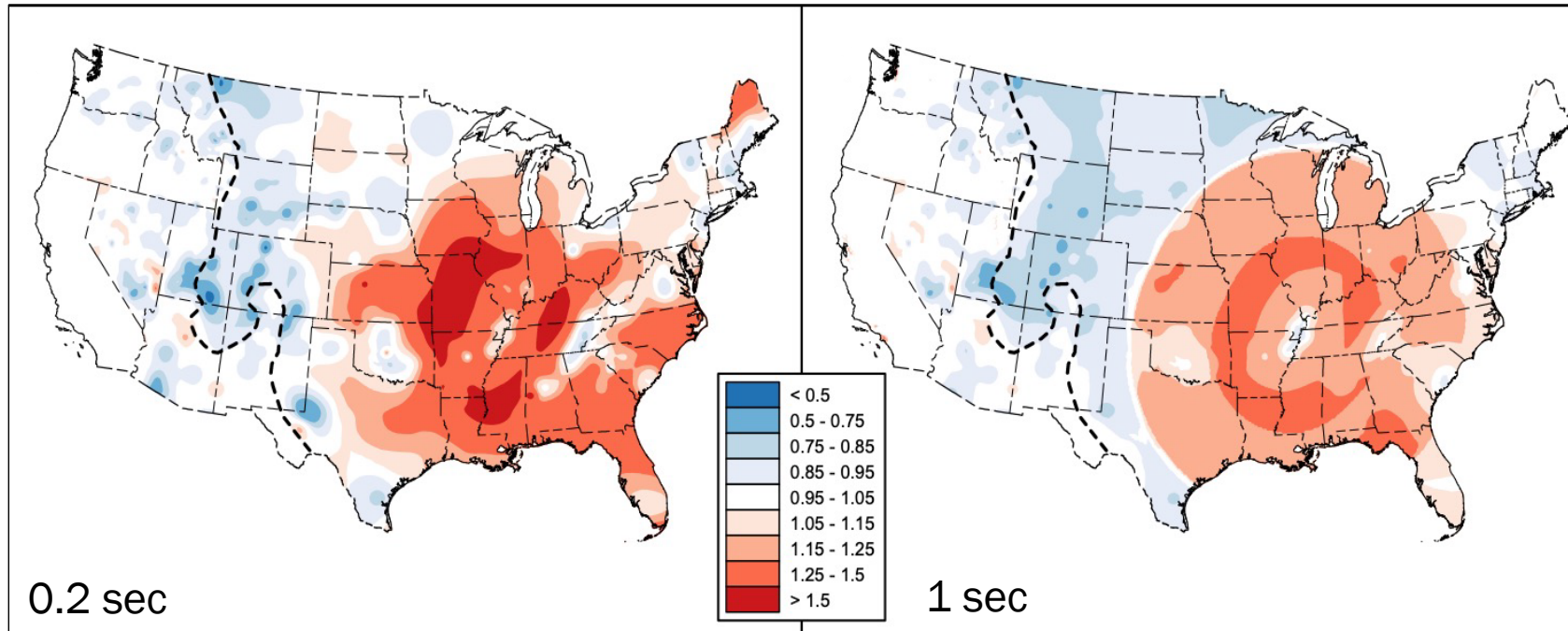

Medians: more significant increases for large M at mid-large distances

Epistemic uncertainty: increased significantly for large M, more around 70-100 km

Aleatory uncertainty: minor changes

Site-effect model: only F_{760} in this figure

Seismicity catalog updates: outside CA, mostly affecting intermountain west region

Figure citation: Petersen et al. (2021). The 2018 update of the US National Seismic Hazard Model: Where, why, and how much probabilistic ground motion maps changed. *Earthquake Spectra*.



FEMA



Building Seismic Safety Council



Section 3.2 - Hazard Changes (WUS)

Ratio Maps (2018 local basin depth/2018 default basin depth):
2% in 50-yr uniform hazard, 5 sec, Site Class D (260 m/s)

Disclaimer: This information is preliminary and is subject to revision. It is being provided to meet the need for timely best science. The information is provided on the condition that neither the U.S. Geological Survey nor the U.S. Government shall be held liable for any damages resulting from the authorized or unauthorized use of the information.

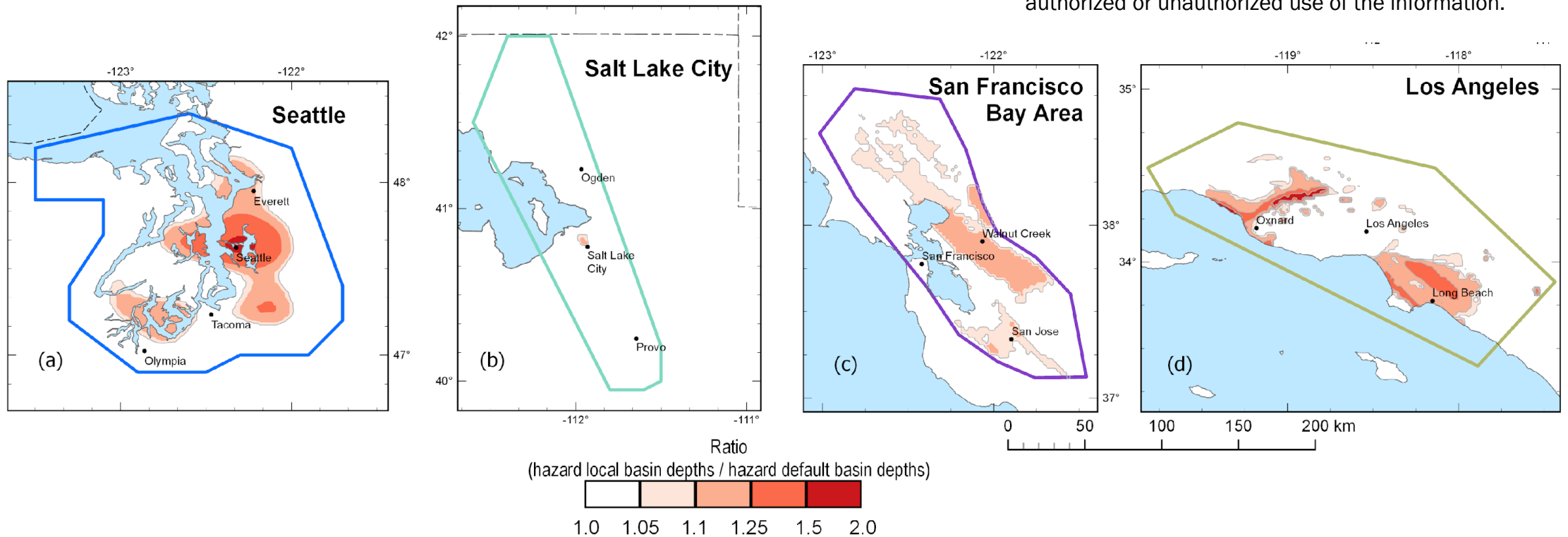

FEMA

Building Seismic Safety Council



Section 3.2 Part 2 – Dissection of Example Changes to the MCE_R Ground Motion Values (Luco): Topics

- Revisions to deterministic caps
- Examples of changes in MCE_R and MCE_G values
- Risk-targeted maximum considered earthquake (MCE_R) spectral response accelerations
- Maximum considered earthquake geometric mean (MCE_G) peak ground accelerations
- Long-period transition maps (T_L)
- USGS seismic design geodatabase and web service

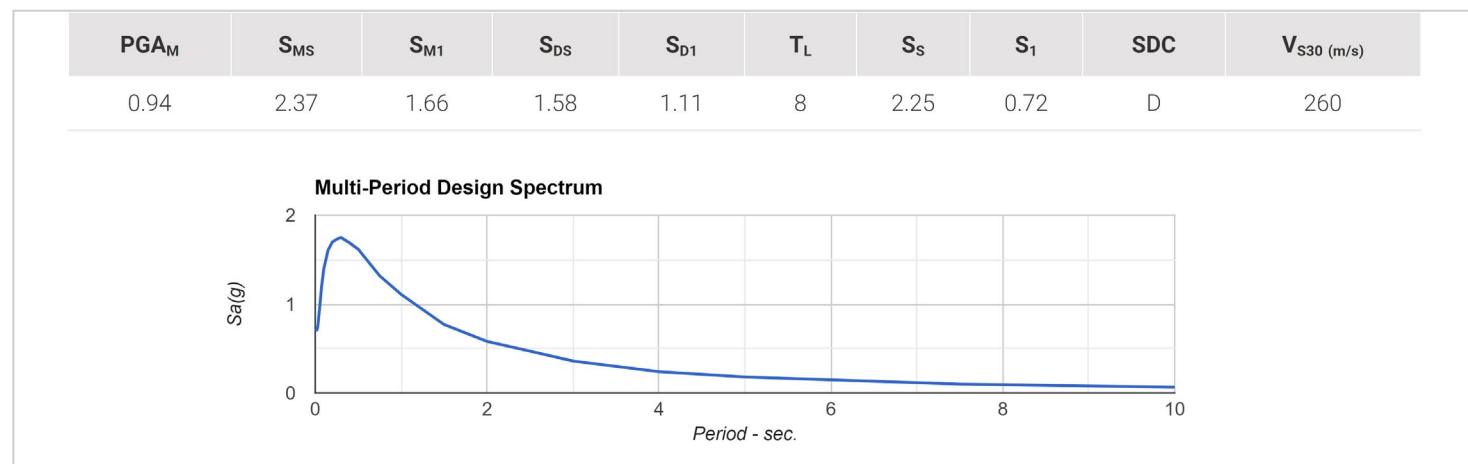

FEMA

Building Seismic
Safety Council



USGS
science for a changing world

Section 3.2 - Deterministic Caps

21.2.2 Deterministic (MCE_R) Ground Motions

The deterministic spectral response acceleration at each period shall be calculated as an 84th-percentile 5% damped spectral response acceleration in the direction of maximum horizontal response computed at that period. The largest such acceleration calculated for scenario earthquakes on all known faults within the region shall be used. The scenario earthquakes shall be determined from deaggregation for the probabilistic spectral response acceleration at each period. Scenario earthquakes contributing less than 10% of the largest contributor at each period shall be ignored.



FEMA



Building Seismic
Safety Council



Section 3.2 - Examples of Changes in MCE_R Values

Table C22-3 Comparison of short-period MCE_R spectral response acceleration values from these Provisions, ASCE/SEI 7-16, and ASCE/SEI 7-10. The S_{MS} values are for the default site class.

Location Name	ASCE/SEI 7-10		ASCE/SEI 7-16		2020 Provisions	
	S_S (g)	S_{MS} (g)	S_S (g)	S_{MS} (g)	S_S (g)	S_{MS} (g)
Los Angeles, CA	2.40	2.40	1.97	2.36	2.25	2.37
Century City, CA	2.17	2.17	2.11	2.53	2.37	2.49
Northridge, CA	1.69	1.69	1.74	2.08	2.09	2.26
Long Beach, CA	1.64	1.64	1.68	2.02	1.90	2.03
Irvine, CA	1.55	1.55	1.25	1.50	1.43	1.68
Riverside, CA	1.50	1.50	1.50	1.80	1.50	1.67
San Bernardino, CA	2.37	2.37	2.33	2.79	2.78	2.97
San Luis Obispo, CA	1.12	1.18	1.09	1.31	1.23	1.45
San Diego, CA	1.25	1.25	1.58	1.89	1.74	1.80
Santa Barbara, CA	2.83	2.83	2.12	2.54	2.37	2.44
Ventura, CA	2.38	2.38	2.02	2.42	2.25	2.38



Section 3.2 - Examples of Changes in SDC

Table C22-6 Comparison of seismic design categories from these *Provisions*, *ASCE/SEI 7-16*, and *ASCE/SEI 7-10*, for the default site class and risk categories I, II, or III. The “SDCs” categories are determined from Table 11.6-1 (“Seismic Design Category Based on Short-Period Response Acceleration Parameter”) alone, but only where $S_I < 0.75g$.

Location Name	ASCE/SEI 7-10		ASCE/SEI 7-16		2020 Provisions	
	"SDCs"	SDC	"SDCs"	SDC	"SDCs"	SDC
Los Angeles, CA	N/A	E	D	D	D	D
Century City, CA	N/A	E	N/A	E	N/A	E
		D	D	D	D	D
		D	D	D	N/A	E
		D	D	D	D	D
		D	D	D	D	D
	A	E	N/A	E		
		D	D	D		
San Diego, CA	D	D	D	D		
Santa Barbara, CA	N/A	E	N/A	E		
Ventura, CA	N/A	E	N/A	E		

From ASCE 7-10 to ASCE 7-16, SDC decreases at 2 of 34 locations, from E to D.

From ASCE 7-16 to 2020 Provisions, SDC increases at 4 of 34 locations, from D to E, mostly due to deterministic capping and basin effects.



FEMA

Building Seismic Safety Council



Section 3.2 - BSSC Tool for Seismic Design Map Values

<https://doi.org/10.5066/F7NK3C76>

The screenshot shows a web browser window with the URL <https://www.wbdg.org/additional-resources/tools/bssc2020nehrp>. The page header features the WBDG logo (Whole Building Design Guide) and navigation links for 'CREATE ACCOUNT', 'LOG IN', and 'SEARCH'. A dark blue navigation bar contains menu items: 'DESIGN RECOMMENDATIONS', 'PROJECT MANAGEMENT - O & M', 'FEDERAL FACILITY CRITERIA', 'CONTINUING EDUCATION', and 'ADDITIONAL RESOURCES'. The breadcrumb trail reads: 'ADDITIONAL RESOURCES / TOOLS / BSSC TOOL FOR 2020 NEHRP PROVISIONS SEISMIC DESIGN MAP VALUES'. The main heading is 'BSSC Tool For 2020 NEHRP Provisions Seismic Design Map Values', and the version is noted as 'Version: Beta'.



FEMA



Building Seismic Safety Council



Section 3.3 – Multi-Period Response Spectra (Kircher): Topics

- Design parameters and response spectra of ASCE/SEI 7-16
- Site-specific requirements of ASCE/SEI 7-16
- New ground motion parameters of ASCE/SEI 7-22 Chapter 11
- New site classes of ASCE/SEI 7-22 Chapter 20
- New site-specific analysis requirements of ASCE/SEI 7-22 Chapter 21
- Example comparisons of design response spectra

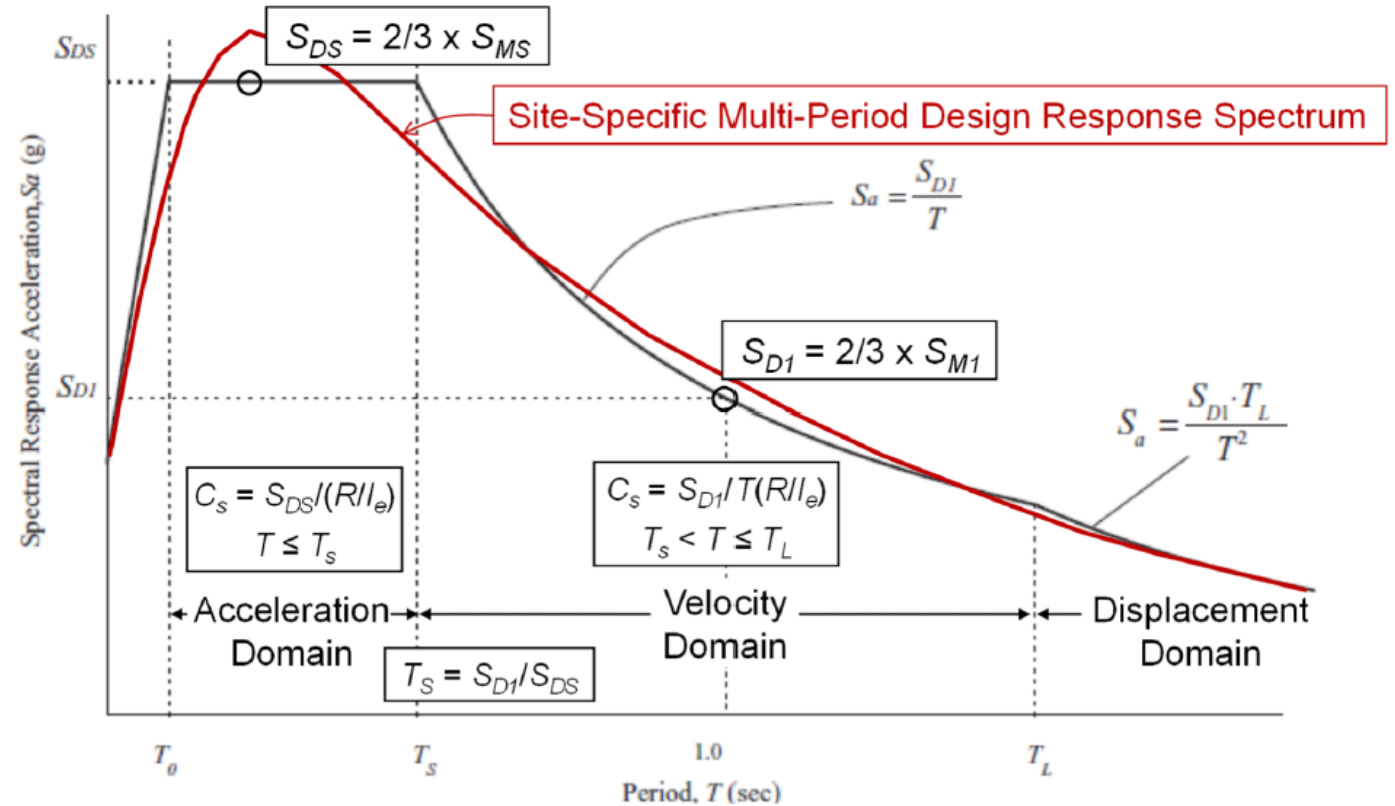

Section 3.3 - The “Problem” with ASCE 7-10

- For softer sites, in particular those where seismic hazard is governed by large magnitude earthquakes:
 - Frequency content of ground motions (spectrum shape) is not accurately characterized by of the two-period design response spectrum and site coefficients
 - Design ground motions are significantly underestimated (e.g., by as much as a factor of 2 at longer response periods)



FEMA

 Building Seismic
Safety Council



Section 3.3 - Comparison of ASCE/SEI 7-16 Two-Period (ELF) Design Spectrum w/o Spectrum Shape Adjustment with MPRS Design Spectrum

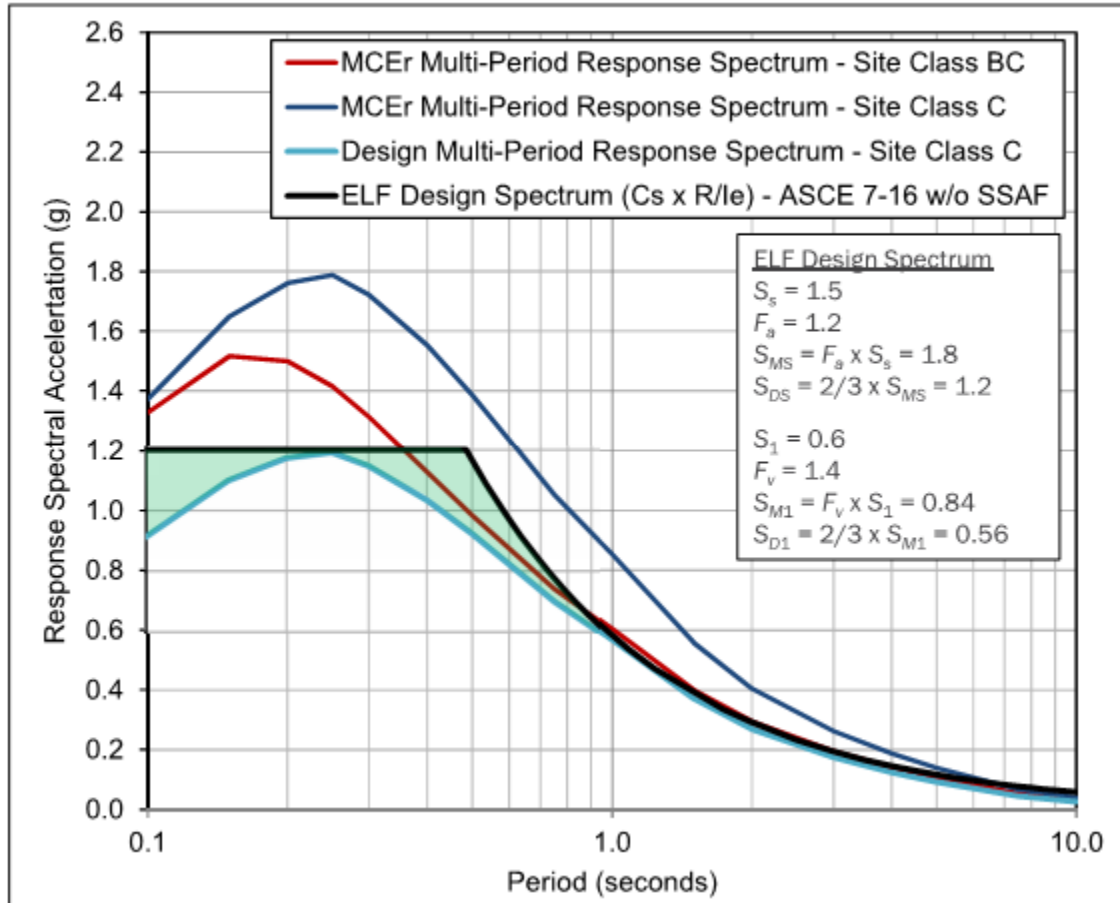

MPRS based on M7.0 earthquake ground motions at 6.8 km – Site Class C

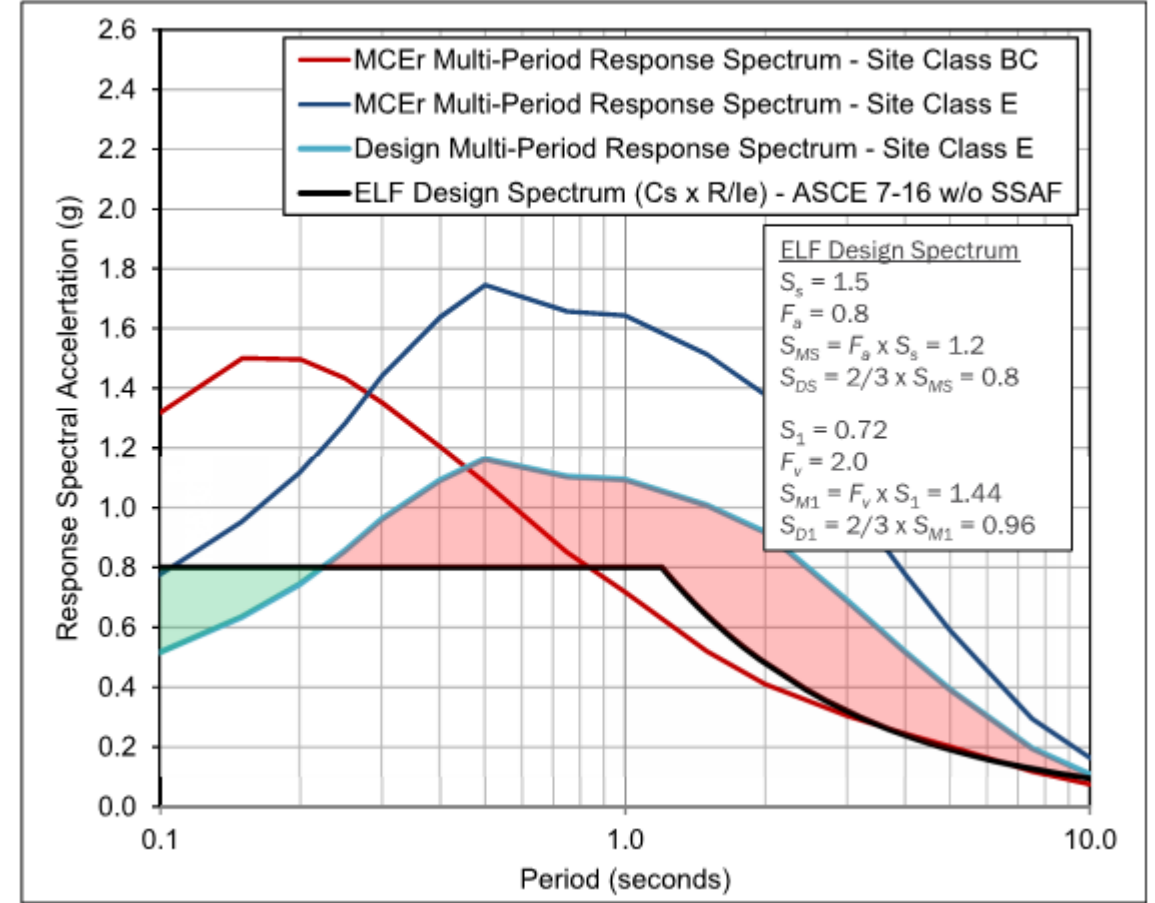

MPRS based on M8.0 earthquake ground motions at 9.9 km – Site Class E



FEMA

Building Seismic Safety Council



Section 3.3 - Interim Solution of ASCE/SEI 7-16 (2015 NEHRP Provisions)

- Require site-specific analysis to determine design ground motions for softer sites, but provide exceptions to permit design using “conservative” values seismic design parameters
 - Site Class D - Site-specific ground motion procedures are required for structures on Site Class D sites where values of S_1 are greater than or equal to 0.2.
 - An exception permits ELF (and MRSA) design using a “conservative” value of the seismic design coefficient based on a 50 percent increase in the value of the seismic parameter S_{M1} (S_{D1}), effectively extending the acceleration domain to $1.5T_s$
 - Site Class E - Site-specific ground motion procedures required for structures on Site Class E sites where values of S_s are greater than or equal to 1.0 (or S_1 greater than 0.2)
 - An exception permits ELF design using a “conservative” value of the seismic design coefficient based on the seismic parameter S_{MS} (S_{DS}) for Site Class C, regardless of the design period, T , effectively eliminating the velocity domain



Section 3.3 - Long-Term Solution - MPRS in 2020 NEHRP Provisions and ASCE/SEI 7-22

- Define MCE_R and design ground motions in terms of MPRS (e.g., for MRSA design or as the basis for selecting records for NRHA)
- Derive values of seismic design parameters (e.g., S_{DS} and S_{D1}) from the MPRS of interest (e.g., for ELF design)
- Provide MPRS and associated values of seismic design parameters for User-specified values of:
 - Site Location (latitude, longitude)
 - Site Class
 - From USGS web service at <http://doi.org/10.5066/F7NK3C76> (aka USGS Seismic Design Geodatabase for ASCE 7-22) and
 - Other user-friendly providers (e.g., WBDG, ASCE 7 Hazard Tool, etc.)



FEMA

 Building Seismic
Safety Council



Section 3.3 - New Site Classes and Associated Values of Shear Wave Velocities (Table 2.2-1, FEMA P-2078, June 2020)

Site Class		Shear Wave Velocity, V_{s30} (fps)			USGS ² V_{s30} (mps)
Name	Description	Lower Bound ¹	Upper Bound ¹	Center	
A	Hard rock	5,000			1,500
B	Medium hard rock	3,000	5,000	3,536	1,080
BC	Soft rock	2,100	3,000	2,500	760
C	Very dense soil or hard clay	1,450	2,100	1,732	530
CD	Dense sand or very stiff clay	1,000	1,450	1,200	365
D	Medium dense sand or stiff clay	700	1,000	849	260
DE	Loose sand or medium stiff clay	500	700	600	185
E	Very loose sand or soft clay		500		150

1. Upper and lower bounds, Table 20.3-1, ASCE/SEI 7-22.
2. Center of range (rounded) values used by USGS to develop MPRS.



Section 3.3 - MPRS Format

- Values available for conterminous US regions with ground motion models for all combinations of 22 periods and 8 site classes

Period <i>T</i> (s)	5%-Damped Response Spectral Acceleration or PGA by Site Class (g)							
	A	B	BC	C	CD	D	DE	E
0.00	0.501	0.565	0.658	0.726	0.741	0.694	0.607	0.547
0.010	0.503	0.568	0.662	0.730	0.748	0.703	0.617	0.547
0.020	0.519	0.583	0.676	0.739	0.749	0.703	0.617	0.547
0.030	0.596	0.662	0.750	0.792	0.778	0.703	0.617	0.547
0.050	0.811	0.888	0.955	0.958	0.888	0.758	0.620	0.551
0.075	1.040	1.142	1.214	1.193	1.076	0.900	0.713	0.624
0.10	1.119	1.252	1.371	1.368	1.241	1.040	0.825	0.724
0.15	1.117	1.291	1.535	1.606	1.497	1.266	1.002	0.875
0.20	1.012	1.194	1.500	1.710	1.662	1.440	1.153	1.010
0.25	0.897	1.075	1.397	1.714	1.766	1.584	1.299	1.153
0.30	0.810	0.976	1.299	1.665	1.829	1.705	1.443	1.301
0.40	0.689	0.833	1.138	1.525	1.823	1.802	1.607	1.484
0.50	0.598	0.724	1.009	1.385	1.734	1.803	1.681	1.596
0.75	0.460	0.536	0.760	1.067	1.407	1.566	1.598	1.589
1.0	0.368	0.417	0.600	0.859	1.168	1.388	1.512	1.578
1.5	0.261	0.288	0.410	0.600	0.839	1.086	1.348	1.540
2.0	0.207	0.228	0.309	0.452	0.640	0.877	1.192	1.458
3.0	0.152	0.167	0.214	0.314	0.449	0.632	0.889	1.111
4.0	0.120	0.132	0.164	0.238	0.339	0.471	0.655	0.815
5.0	0.100	0.109	0.132	0.188	0.263	0.359	0.492	0.607
7.5	0.063	0.068	0.080	0.110	0.148	0.194	0.256	0.311
10	0.042	0.045	0.052	0.069	0.089	0.113	0.144	0.170
PGA_G	0.373	0.429	0.500	0.552	0.563	0.527	0.461	0.416



Move from Two-Point Spectra (2PRS) to Multi-Point Spectra (MPRS)

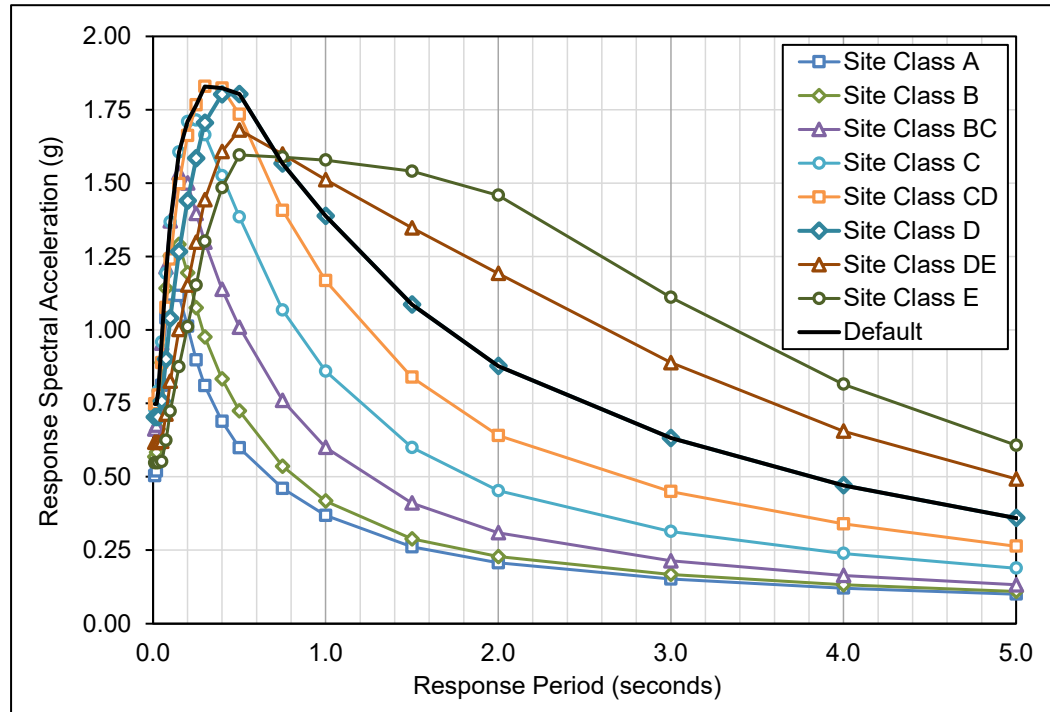

Example MPRS from ASCE/SEI 7-22
Table 21.2-1 (from 2020 NEHRP
Training Materials by C. Kircher)

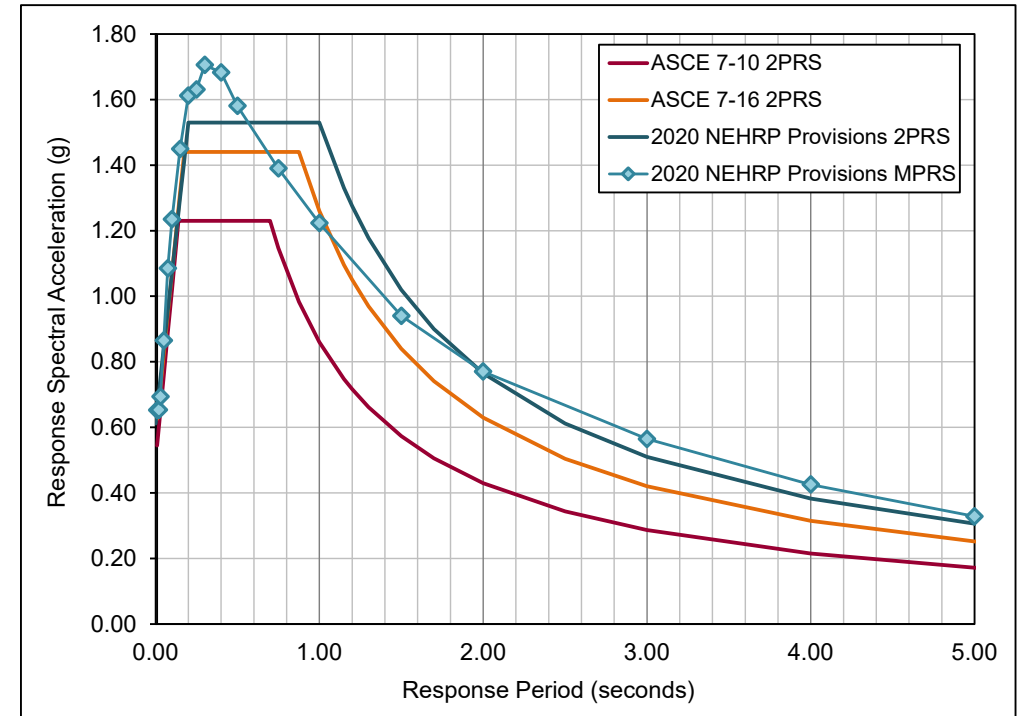

San Mateo, CA for default
soil class (from FEMA
P-2078, Figure 8.2-2)

Velocity domain of the ASCE 7-16 (2PRS) design spectrum includes the 1.5 multiplier of the applicable Section 11.4.8 exception.



FEMA

Building Seismic
Safety Council



Section 3.3 - Design (As Usual) Using New MPRS

- Design Ground Motions
 - Ground motion parameters (and MPRS) are available online from a USGS web service [<https://doi.org/10.5066/F7NK3C76>] for user specified site location (i.e., latitude and longitude) and site conditions (i.e., site class)
 - Site-specific ground motion procedures (Chapter 21) now permit use of MPRS obtained online from the USGS web service (in lieu of a hazard analysis)
- Design Procedures
 - ELF procedures (Chapter 12) are not affected by proposed changes (although values of design parameters, S_{DS} and S_{D1} , would better match the underlying response spectrum of the site of interest)
 - MRSA procedures (Chapter 12) are not affected by proposed changes (although multi-period design spectra would provide a more reliable calculation of dynamic response)



Section 3.4 – Other Changes to Ground Motion Provisions in ASCE/SEI 7-22 (Crouse): Topics

- Maximum Considered Earthquake Geometric Mean (MCE_G) Peak Ground Acceleration (ASCE/SEI 7-22, Section 21.5)
- Vertical Ground Motion for Seismic Design (ASCE/SEI 7-22, Section 11.9)
- Site Class when Shear Wave Velocity Data Unavailable (ASCE/SEI 7-22, Section 20.3)

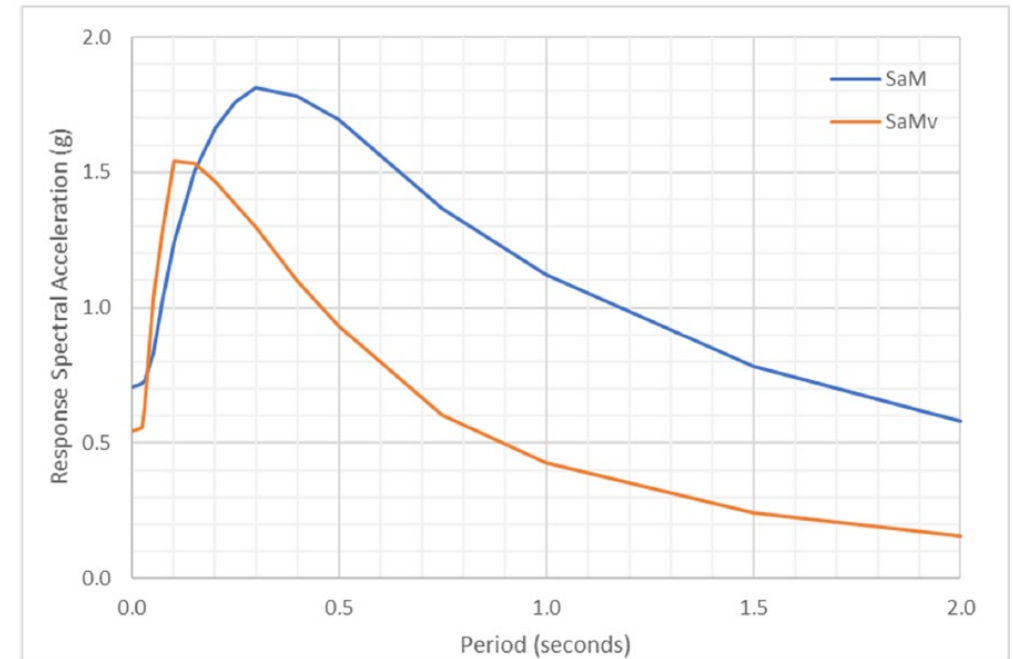

Comparison of S_{aMv} and S_{aM} for Irvine, CA site and Site Class D



FEMA

Building Seismic
Safety Council



Chapter 4 – Ductile Reinforced Concrete Shear Walls

Chapter 4 – Ductile Coupled RC Shear Walls (Ghosh and Dasgupta): Topics

- Ductile coupled shear wall system
- Research justification
- Design example
 - Overall demands
 - Design of shear wall
 - Design of coupling beams

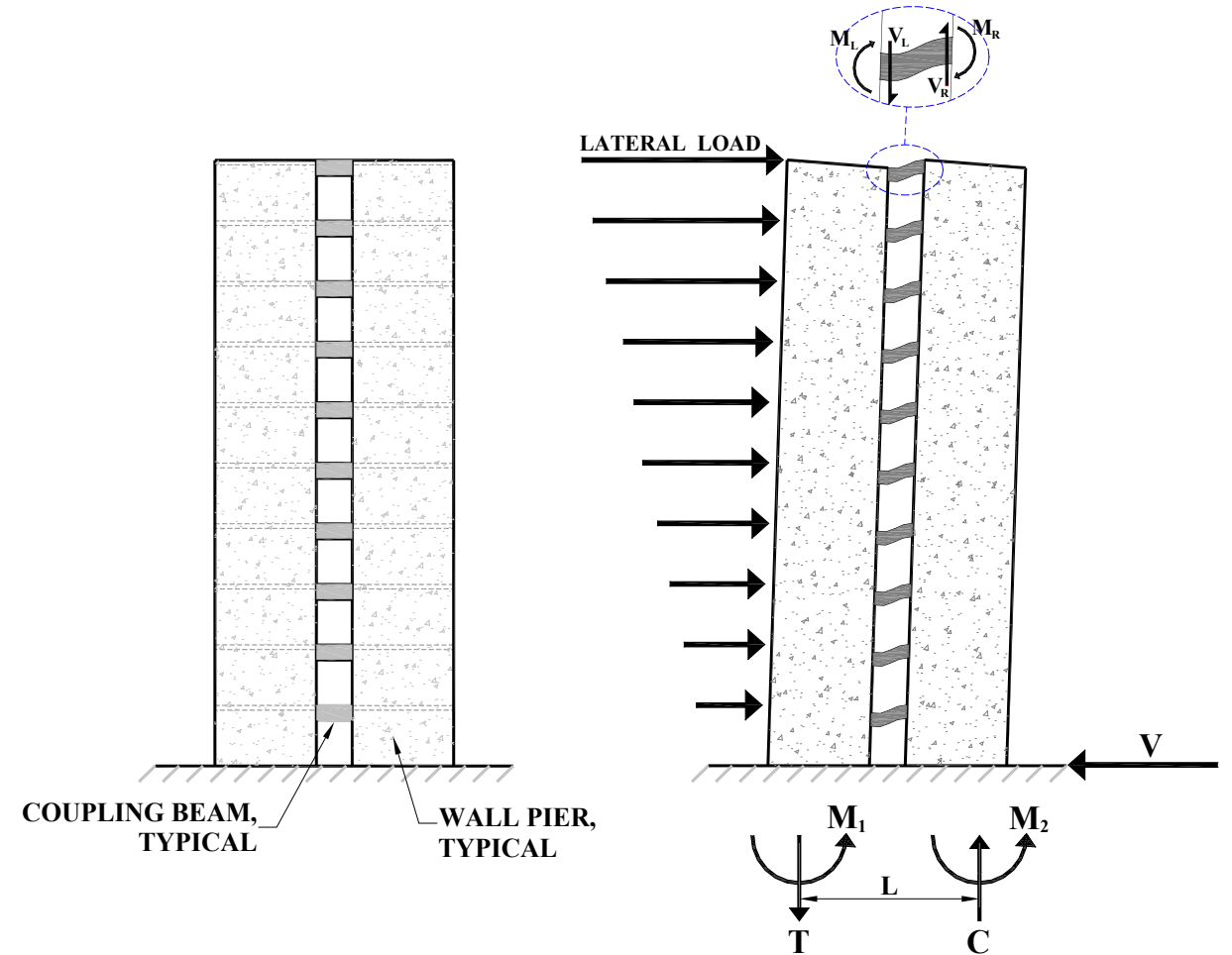
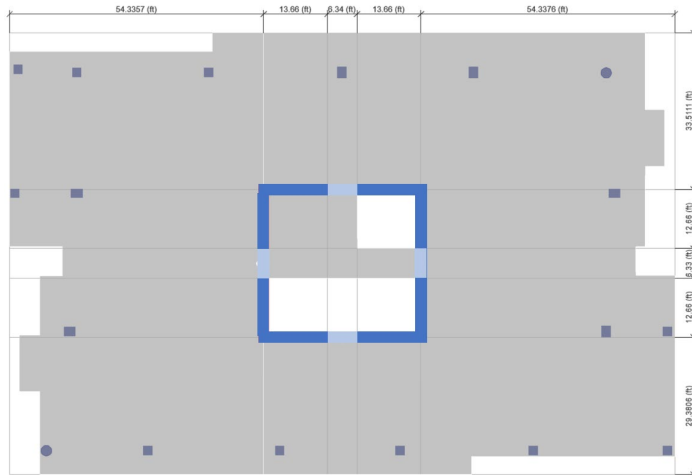

Chapter 2 – Ductile Coupled RC Shear Wall: Details

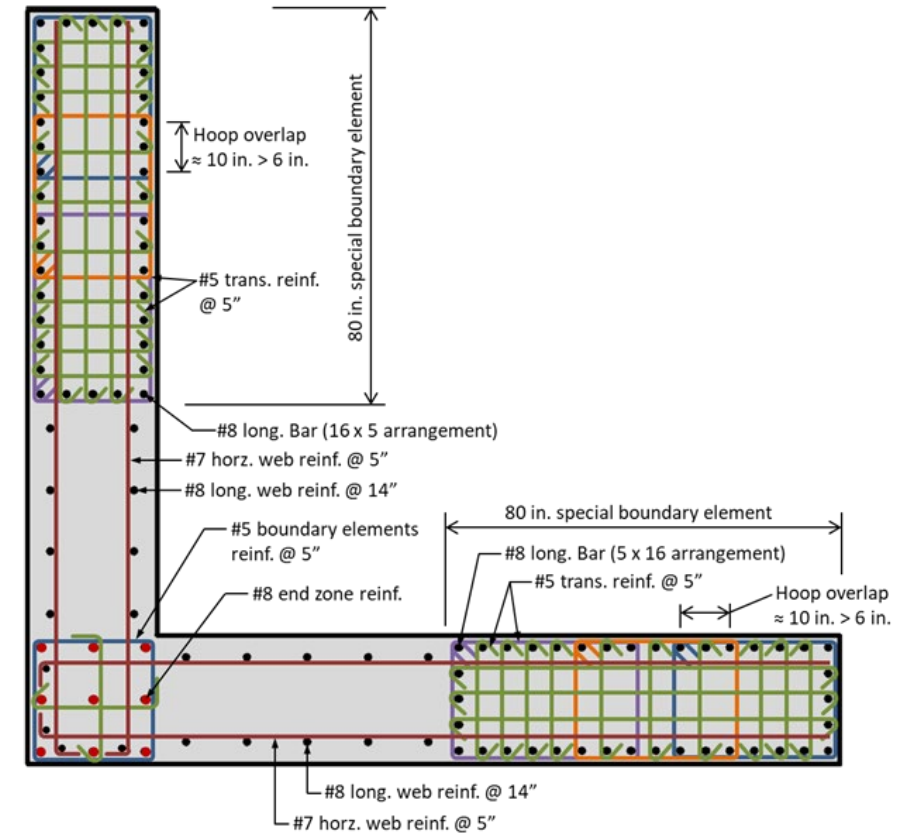
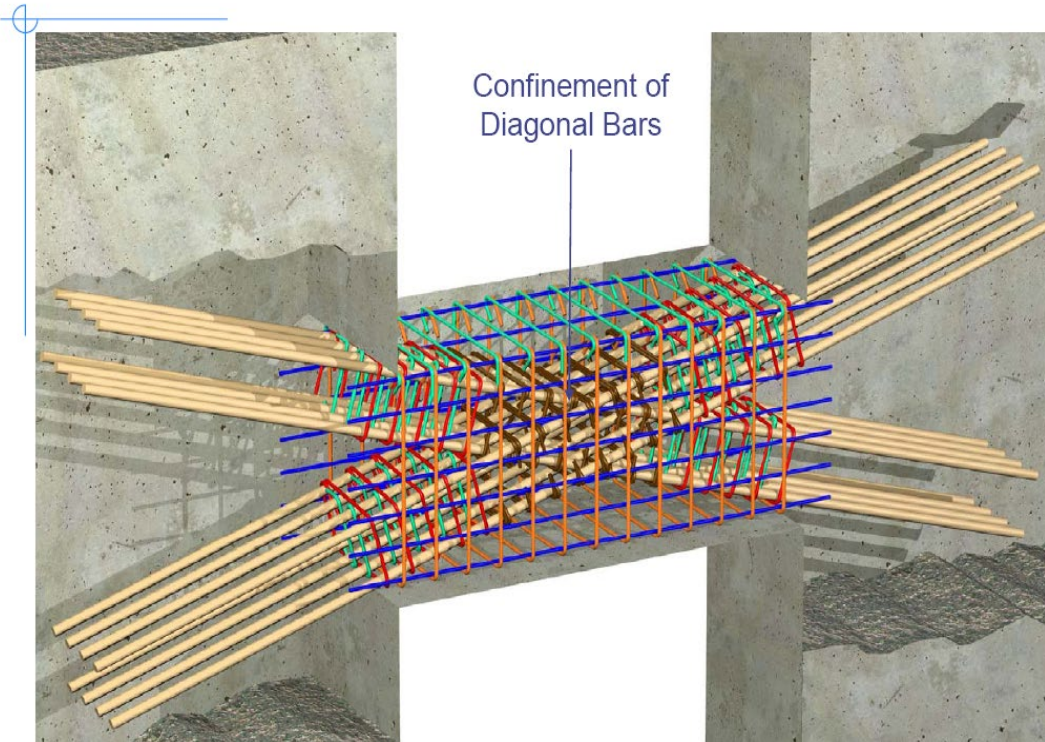

Source: <http://nees.seas.ucla.edu/pankow>

Shear wall plan section



FEMA



Building Seismic Safety Council



Chapter 5 – Coupled Composite Plate Shear Walls/Concrete Filled (C-PSW/CF)

Chapter 5 – C-PSW/CF: Seismic Design Philosophy

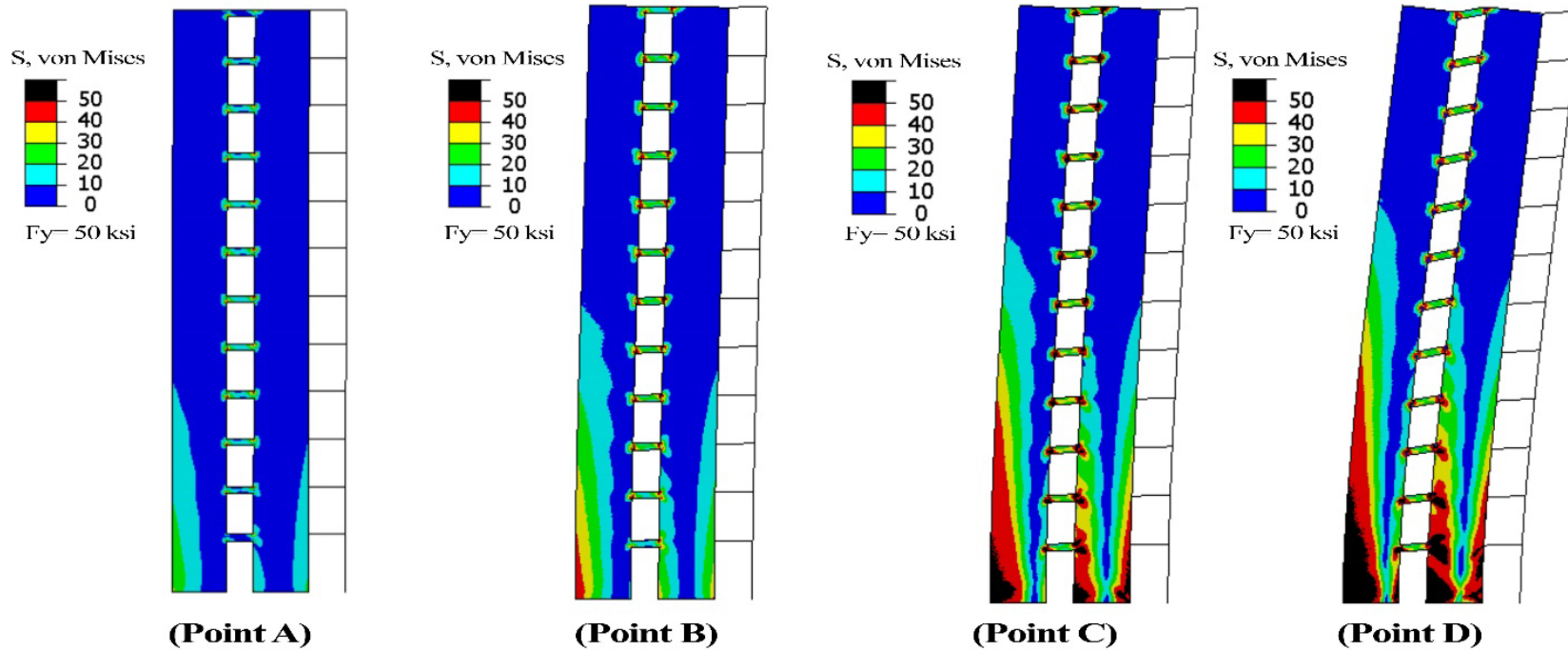
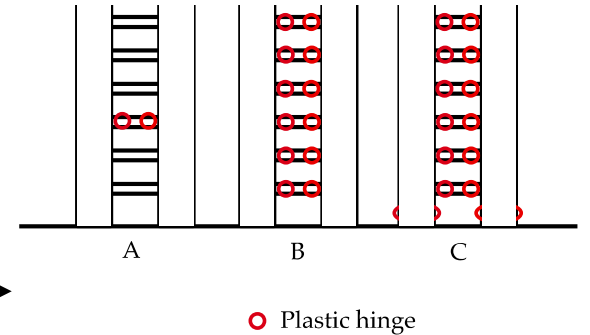
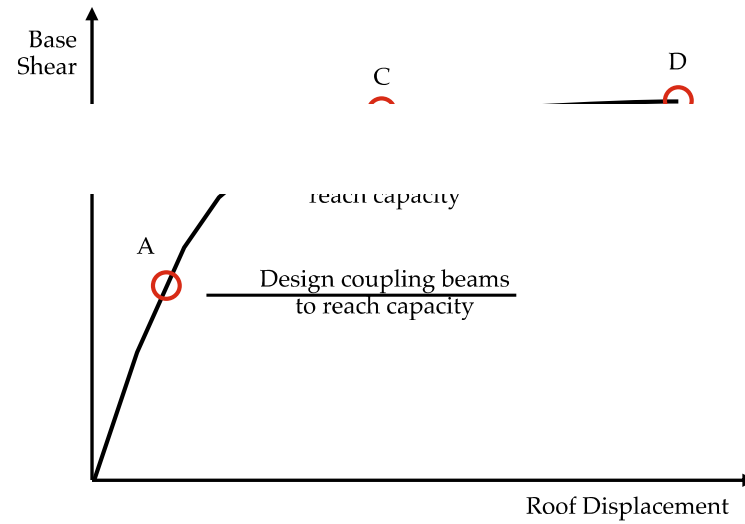

From AISC Design Guide 37
(AISC, 2021)



FEMA

Building Seismic
Safety Council



Chapter 5 – C-PSW/CF: Coupling Beam-to-Wall Connection

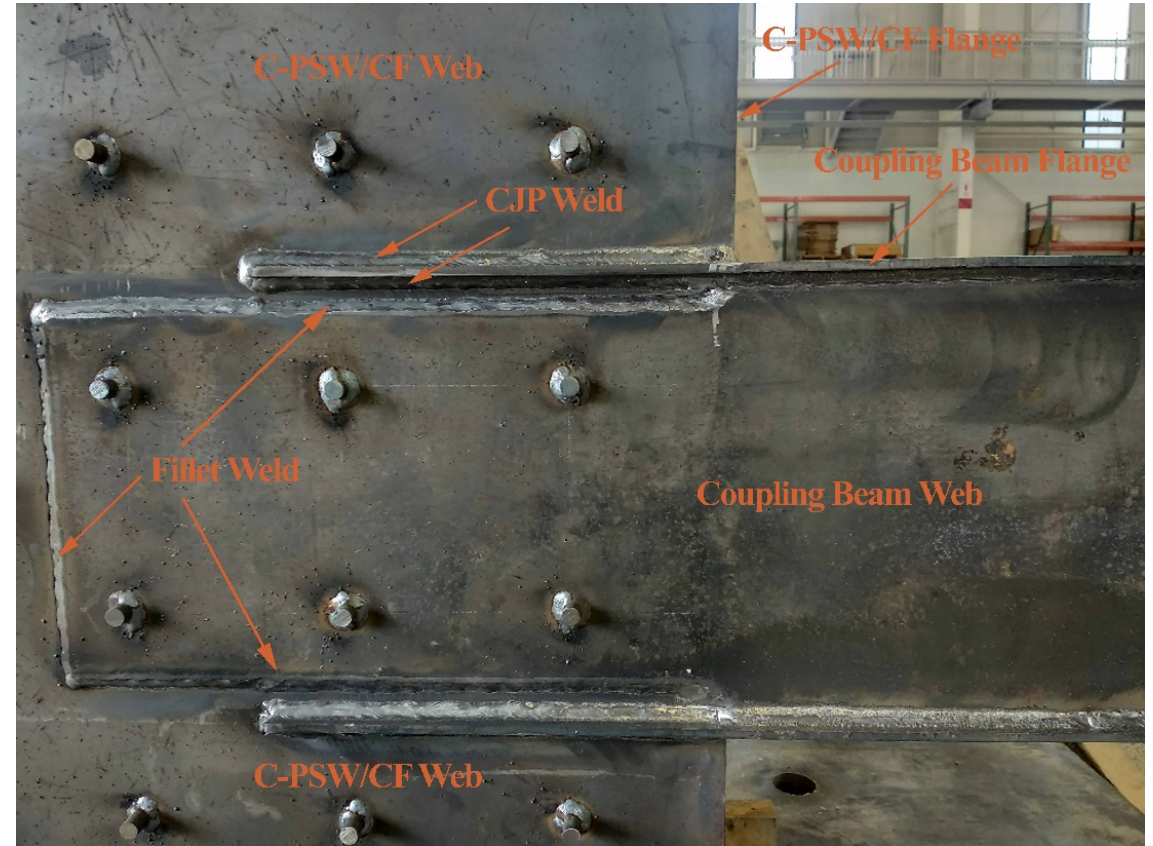
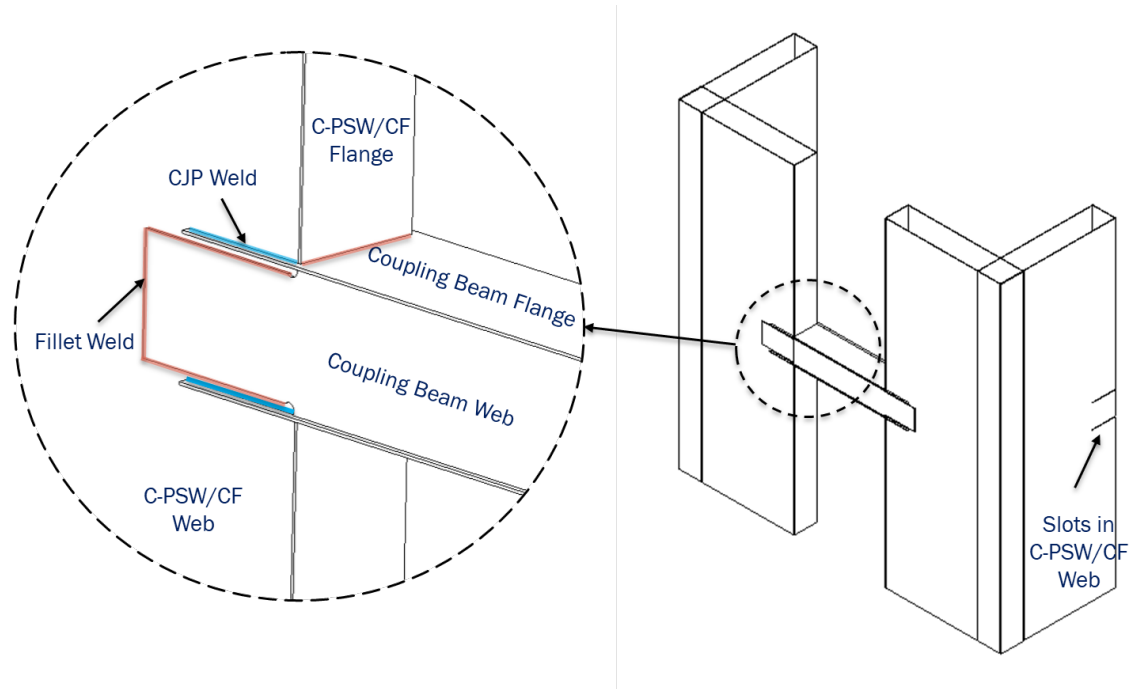

Chapter 6 – Cross-Laminated Timber Shear Walls

Chapter 6 - Cross-Laminated Timber (CLT) Shear Wall (Line and Amini): Topics

- This example features the seismic design of cross-laminated timber shear walls used in a three-story, six-unit townhouse cross-laminated timber building of platform construction
- The CLT shear wall design in this example includes:
 - Check of CLT shear wall shear strength
 - Check of CLT shear wall hold-down size and compression zone length for overturning
 - Check of CLT shear wall deflection for conformance to seismic drift

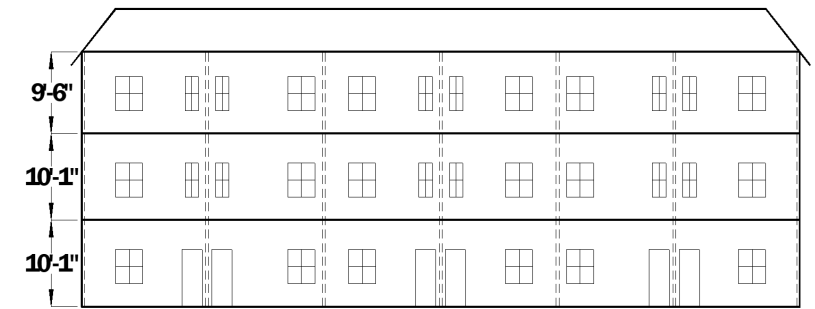

Figure 6-2. Elevation

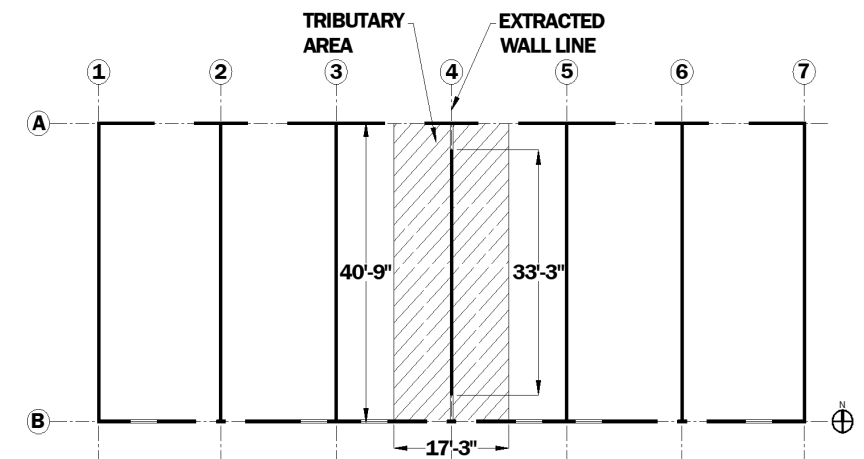

Figure 6-3. Typical Floor Plan (first story openings shown)

Chapter 6 – CLT Shear Wall: Construction



Photo credits: Will Pryce



FEMA

Building Seismic Safety Council



Chapter 6 – CLT: Shear Wall Details

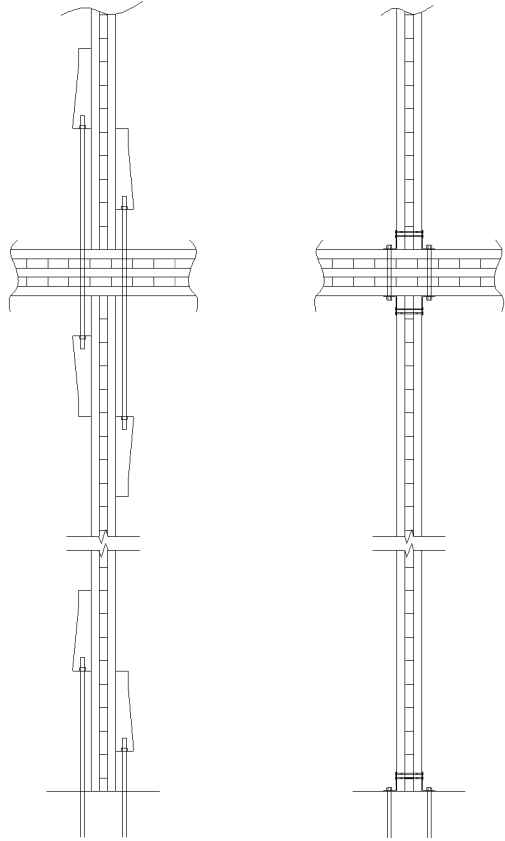

SECTION A-A

SECTION B-B

Wall-to-floor intersections

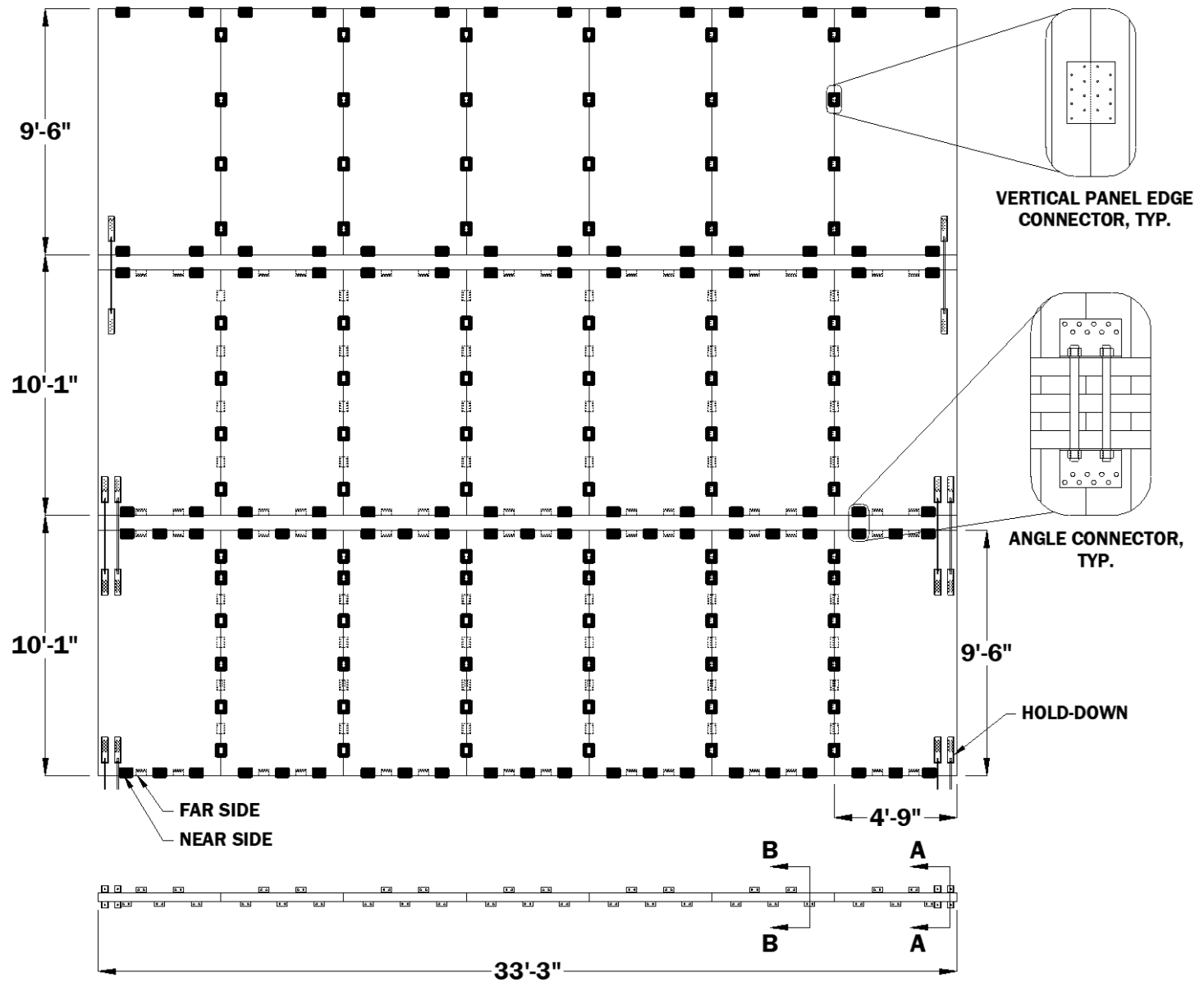

Chapter 7 – Horizontal Diaphragm Design

Chapter 7 – Horizontal Diaphragm Design (Cobeen): Topics

- All diaphragm seismic design methods
 - Sections 12.10.1 and 12.10.2 - **Traditional Diaphragm Design Method** (in ASCE/SEI 7-10)
 - Section 12.10.3 - **Alternative Design Provisions** is added (added in ASCE/SEI 7-16)
 - Cast-in-place concrete, precast concrete, and wood structural panel diaphragms
 - Section 12.10.3 - **Alternative Design Provisions** is expanded (in ASCE/SEI 7-22)
 - Bare steel deck, concrete-filled steel deck diaphragms
 - Section 12.10.4 - **Alternative RWFD Provisions** is added (in ASCE/SEI 7-22)
- Design examples
 - Determination of diaphragm design forces
 - One-story wood assembly hall
 - One-story bare steel deck diaphragm building
 - Multi-story steel building with steel deck diaphragms

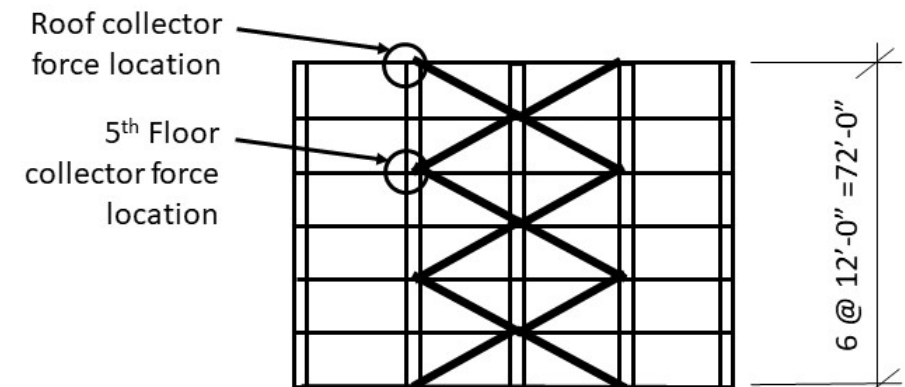

Chapter 7: Diaphragm Seismic Design Method Comparison

- Advantages of using Section 12.10.3 Alternative Design Provisions:
 - Better reflects vertical distribution of diaphragm forces
 - Better reflects effect of diaphragm ductility and displacement capacity
 - May result in lower seismic demands
- Advantages of using Section 12.10.4 Alternative RWFD Method;
 - Better reflects seismic response of RWFD buildings
 - May result in lower seismic demands
 - Is anticipated to result in better performance
- When will the Section 12.10.1 and 12.10.2 Traditional Method result in lower design forces?
 - Bare steel deck diaphragms not meeting the AISI S400 special seismic detailing provisions
 - Other



FEMA



Building Seismic
Safety Council



Chapter 7: Section 12.10.3 Alternative Design Provisions

Part 1: Vertical distribution of seismic forces for near-elastic diaphragm behavior

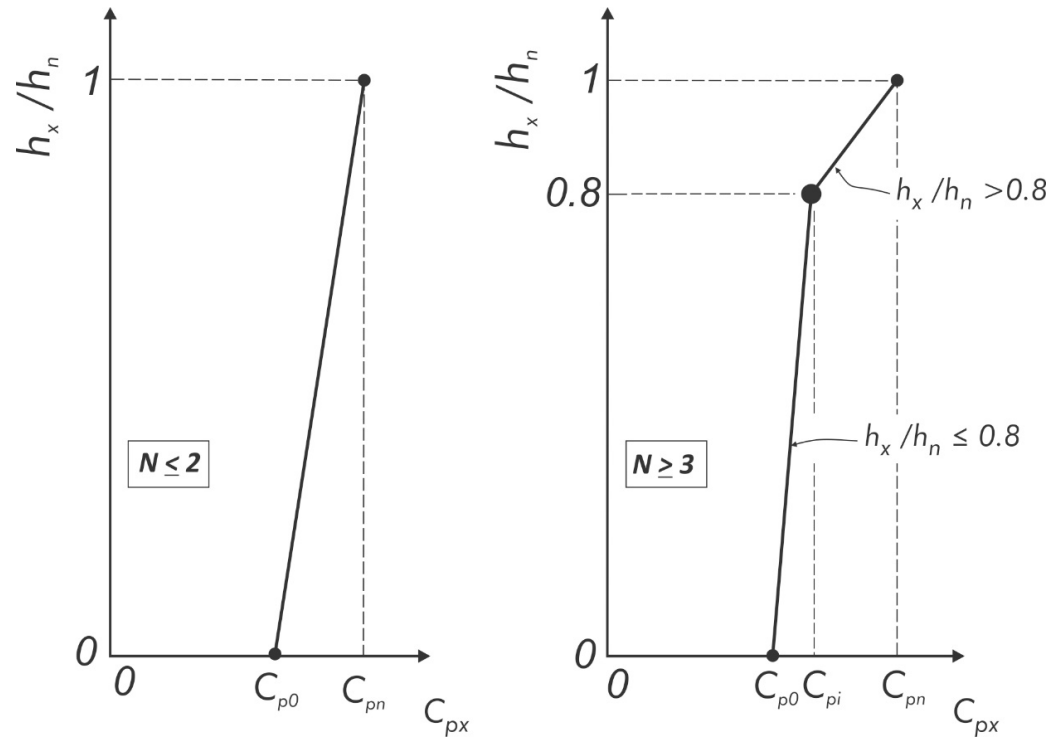

Part 2: Parameter R_s modifies near-elastic forces based on diaphragm ductility and deformation capacity

$$F_{px} = \frac{C_{px}}{R_s} W_{px}$$



FEMA



Building Seismic Safety Council



Chapter 7: Section 12.10.4 Alternative RWFD Design Method

Design to encourage distributed inelastic behavior for improved seismic performance

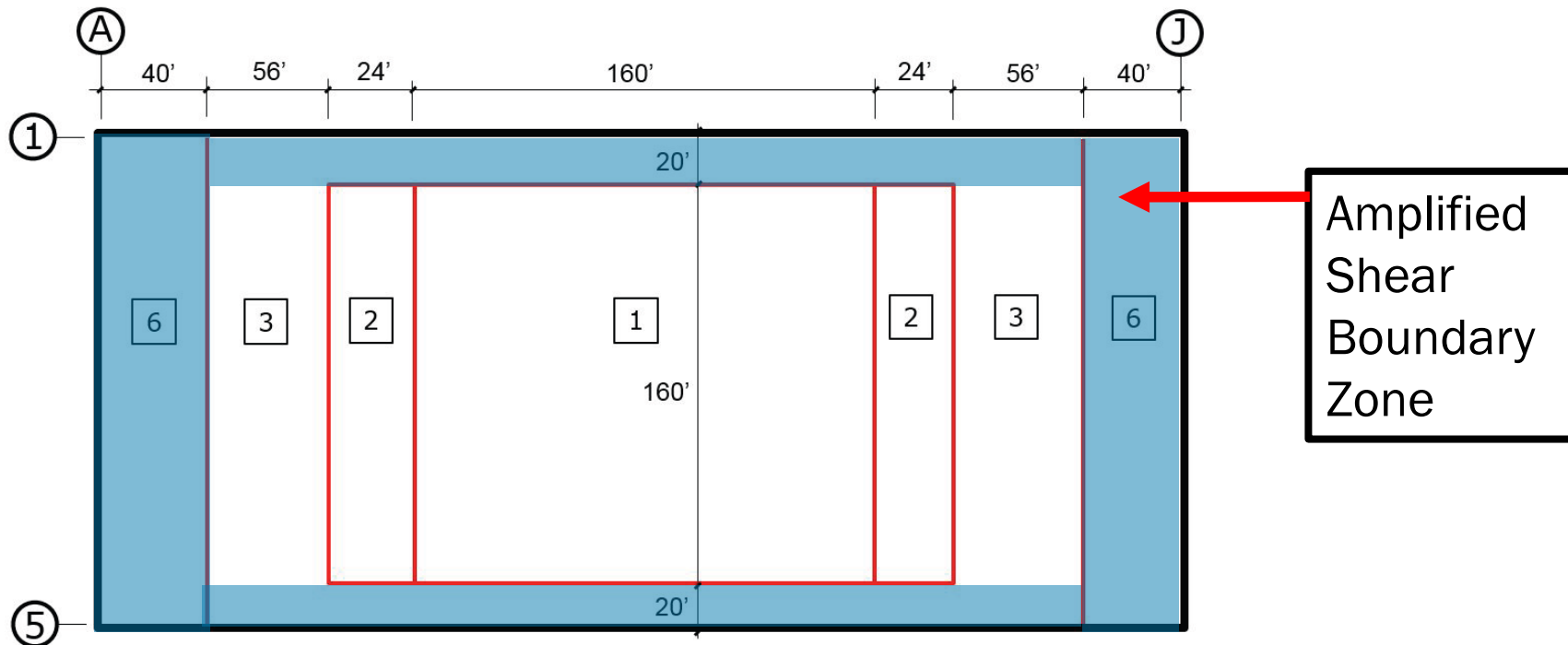

FEMA



Building Seismic Safety Council



Chapter 7: Section 12.10.4 Alternative RWFD Design Method

Optional incorporation of actual seismic response of RWFD buildings for vertical elements – 2 stage analysis

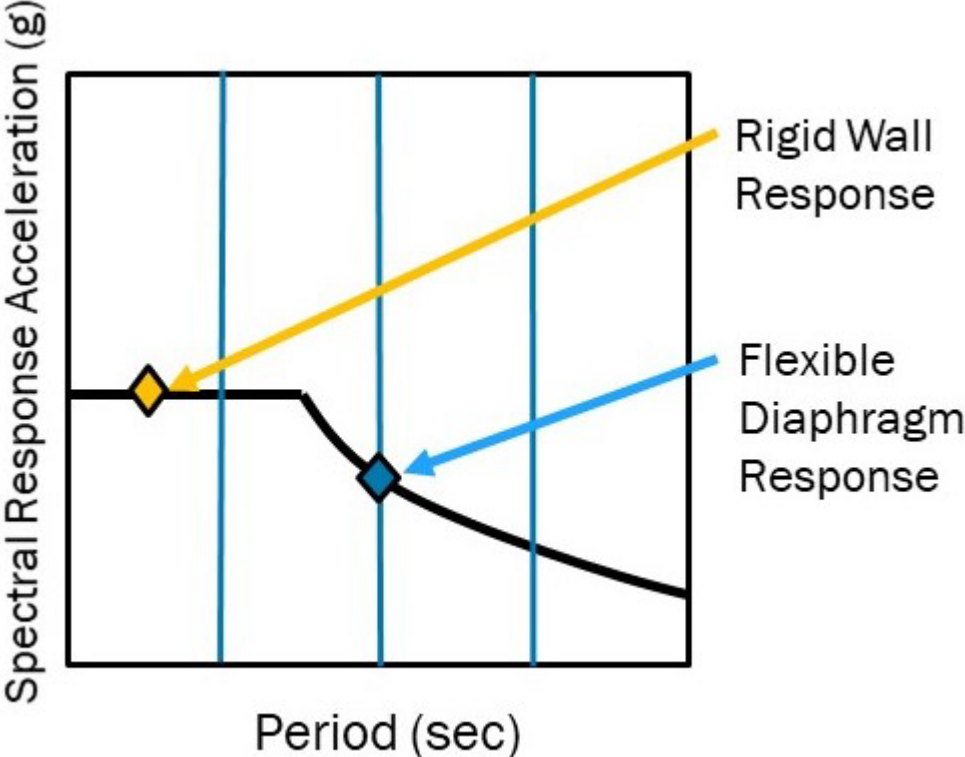
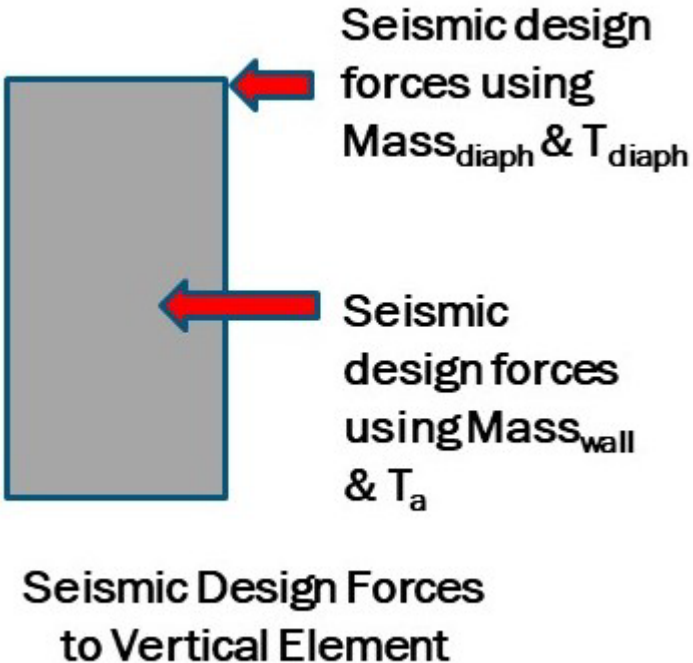

Chapter 8 - Nonstructural Components

Chapter 8 - Design Examples for Nonstructural Components (Lizundia): Topics

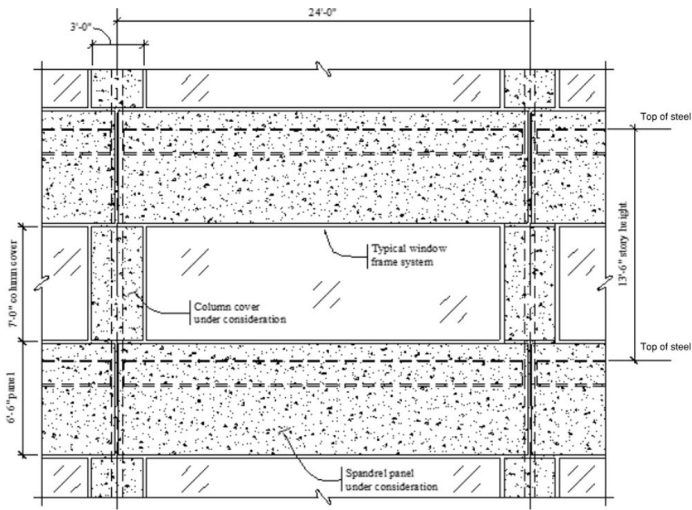

Architectural precast concrete

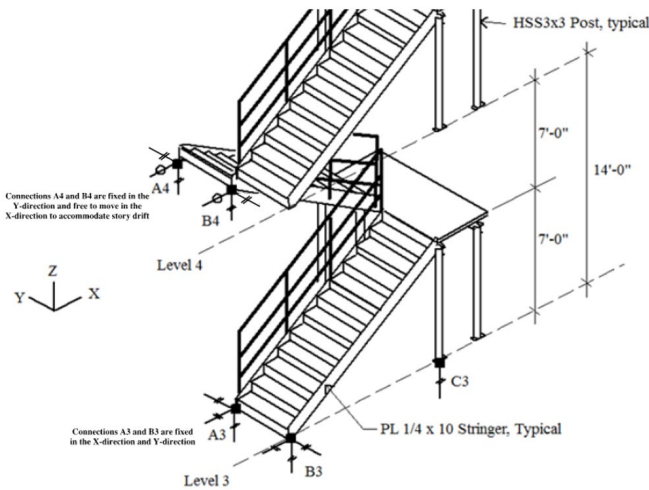

Egress stairs

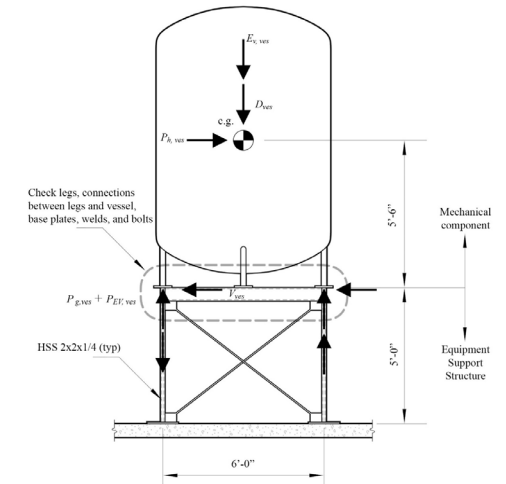

Pressure vessel

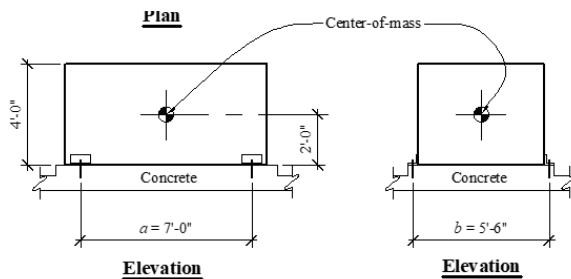

HVAC fan unit

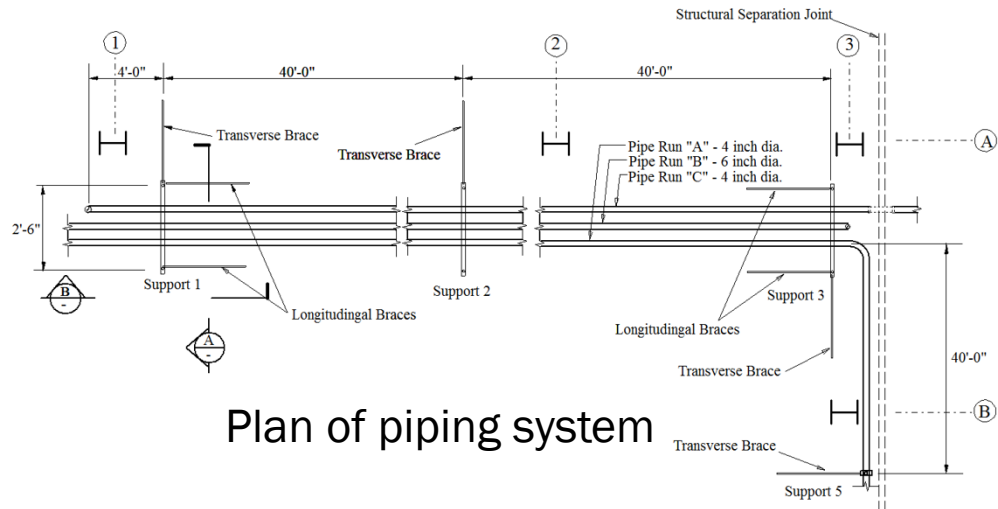

Plan of piping system



FEMA

Building Seismic Safety Council



Chapter 8 - Nonstructural Components Example: Architectural Precast Concrete

Example Summary

- **Nonstructural component:** Architectural – exterior nonstructural wall elements and connections
- **Building seismic force-resisting system:** Steel special moment frames
- **Equipment support:** Not applicable
- **Occupancy:** Office
- **Risk Category:** II
- **Component Importance Factor:** $I_p = 1.0$
- **Number of stories:** 5
- $S_{DS} = 1.487$

Topics Covered

- Providing gravity support and accommodating story drift in cladding
- Spandrel panel
- Column cover
- Prescribed seismic displacements



FEMA

 Building Seismic Safety Council



Chapter 8 - Nonstructural Components Example: Rocking Cladding Mechanism

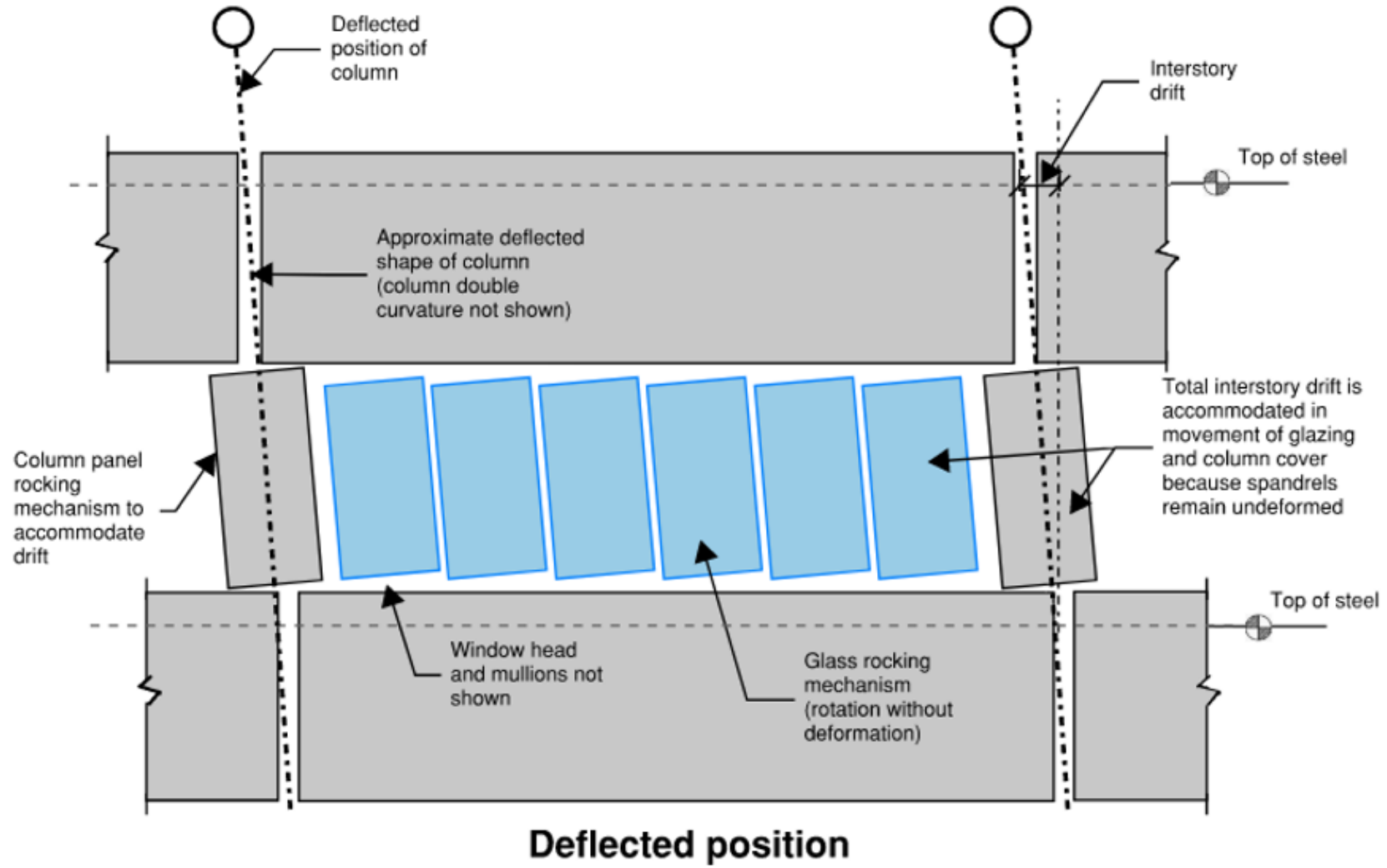

Chapter 8 - Nonstructural Components Example: Piping System Seismic Design

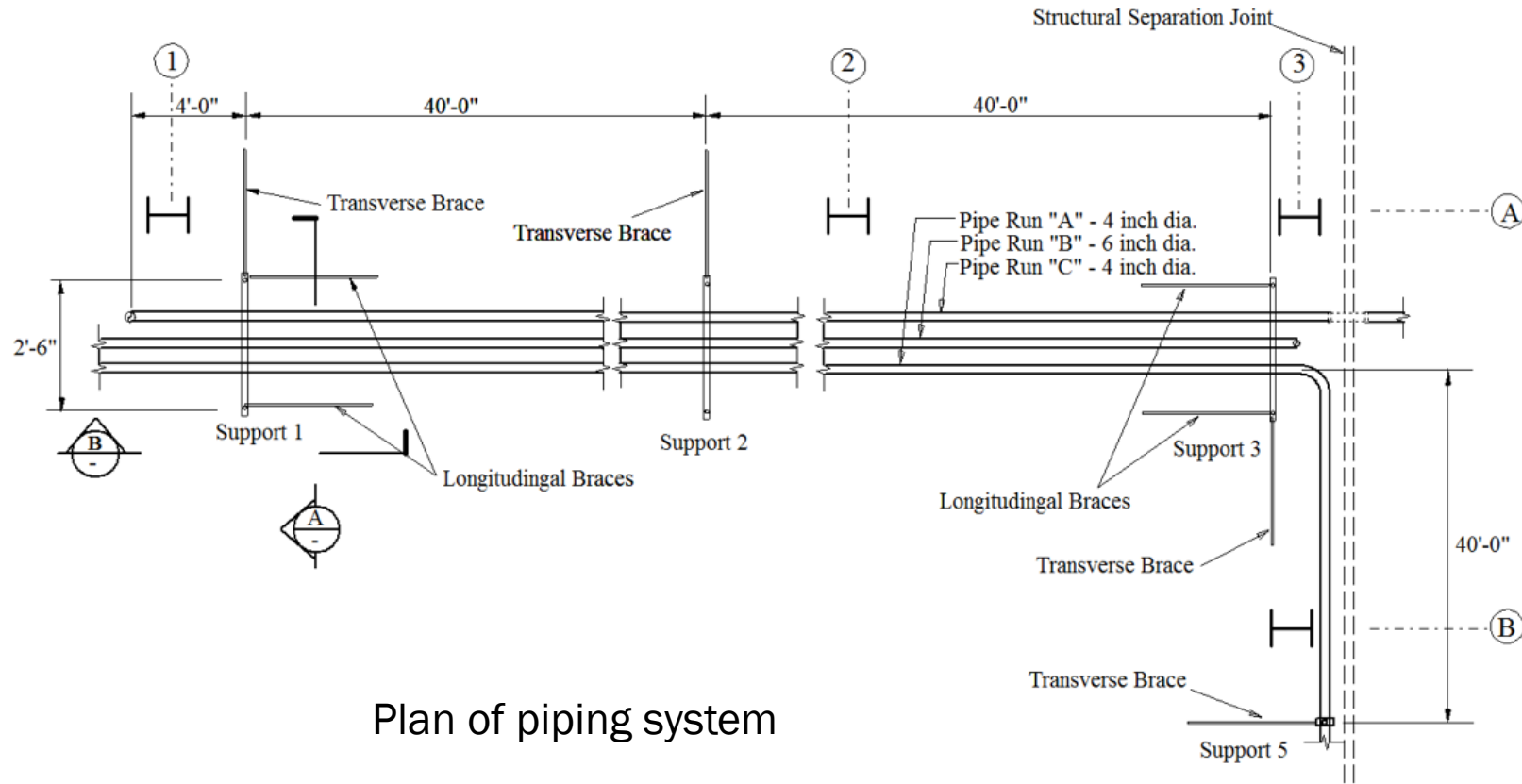

Plan of piping system

Topics Covered

- Piping system design
- Pipe supports and bracing
- Prescribed seismic displacements

Chapter 8 - Nonstructural Components Example: Egress Stairs

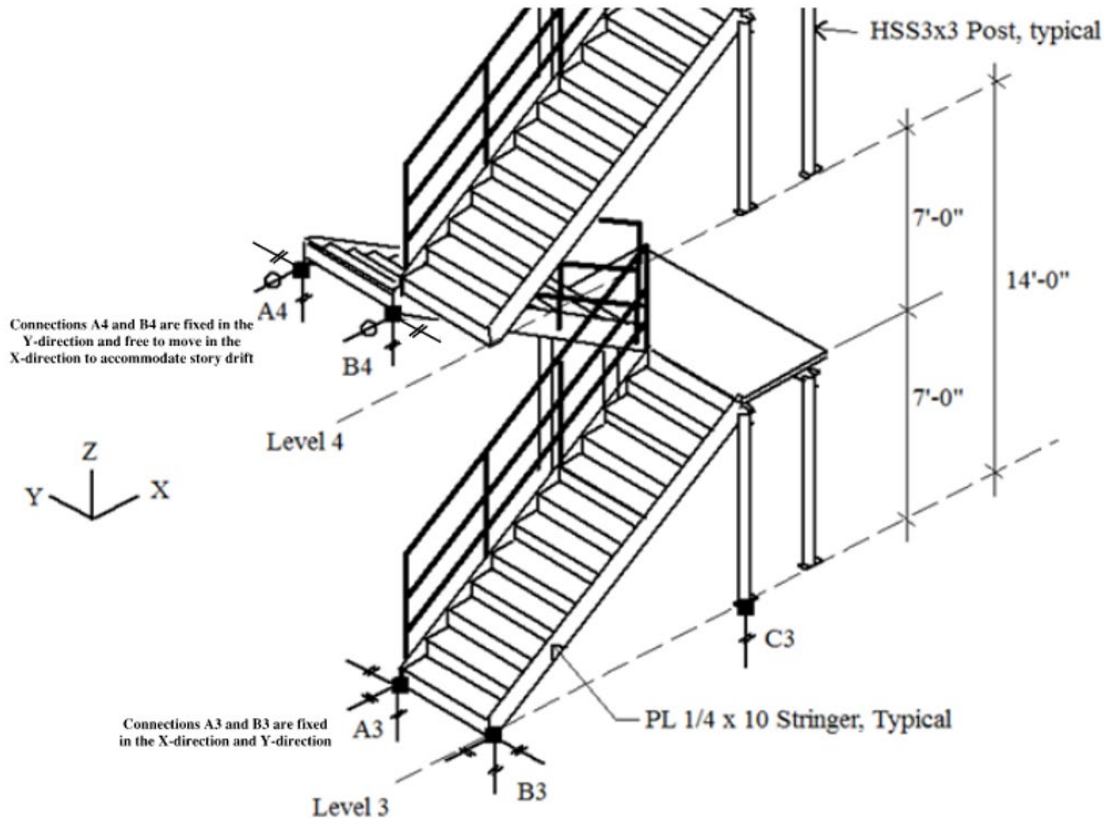

Isometric view of egress stairs

Topics Covered

- Prescribed seismic forces
 - Egress stairways not part of the building seismic force-resisting system
 - Egress stairs and ramp fasteners and attachments
- Prescribed seismic displacements

Chapter 8 - Nonstructural Components Example: Elevated Vessel

Example Summary

- **Nonstructural components:**
Mechanical and electrical – pressure vessel not supported on skirts
- **Building seismic force-resisting system:** Special reinforced concrete shear walls
- **Equipment support:** Equipment support structures and platforms –
Seismic Force-Resisting Systems with $R > 3$
- **Occupancy:** Storage
- **Risk Category:** II
- **Component Importance Factor:** $I_p = 1.0$
- **Number of stories:** 3
- $S_{DS} = 1.20$
- $S_1 = 0.65$

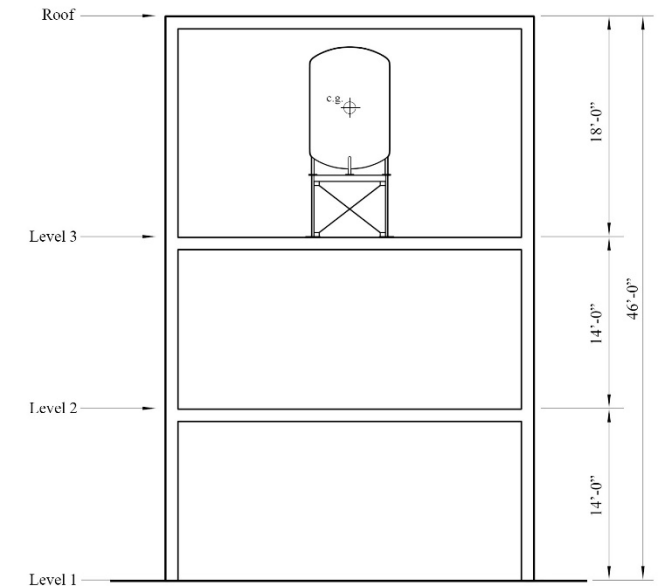

Elevation

Chapter 8 - Nonstructural Components Example: Elevated Vessel

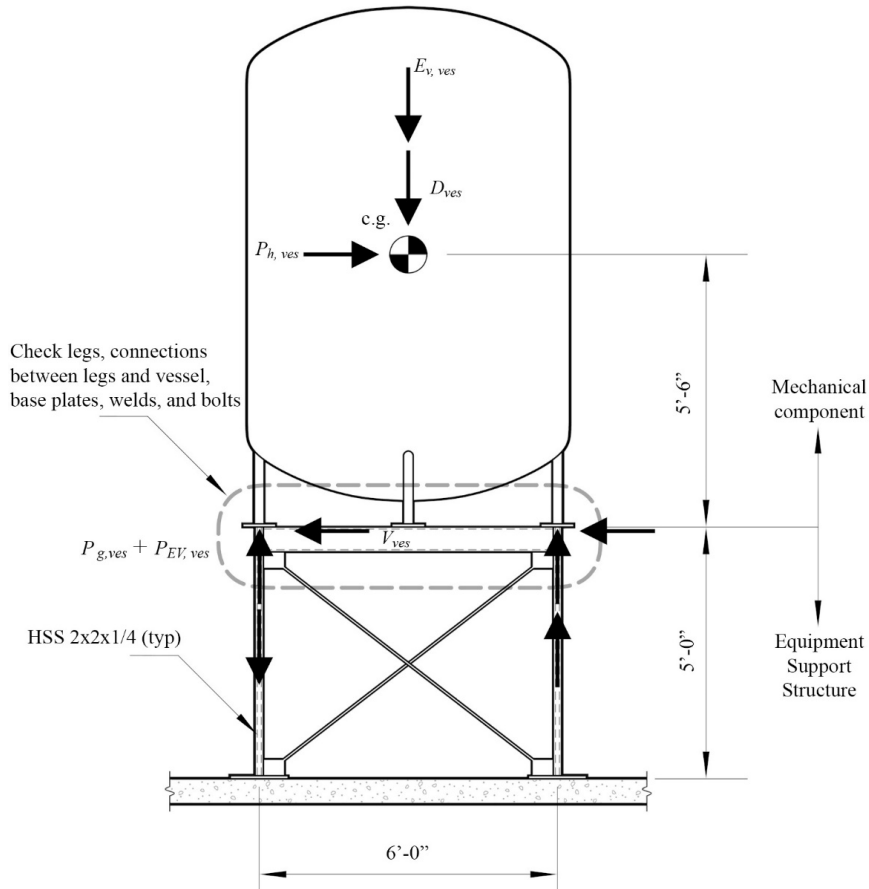

Changes in ASCE/SEI 7-22

ASCE/SEI 7-16 required the nonstructural components and supporting structure to be designed with the same seismic design forces, F_p , regardless of their interaction, and the force was based on the component properties. A platform supporting a pressure vessel would be designed for pressure vessel forces regardless of whether the platform structure was made of concrete, steel braced frames, or steel moment frames.

In ASCE/SEI 7-22, the concept of an equipment support structure or platform has been introduced and defined. Definitions are given in Section 11.2 and properties have been added to Table 13.6-1. Section 13.6.4.6 has been added to ASCE/SEI 7-22 to require that the support structures and platforms be designed in accordance with those properties. This permits a more accurate determination of forces that more realistically reflect the differences in dynamic properties and ductilities between the component and the support structure or platform.

Chapter 8 - Prescribed Seismic Forces: Vessel Support and Attachments

- Vessel and legs weight, $W_{p,ves} = D_{ves} = 5,000$ lb
- Seismic design force, F_p

$$F_p = 0.4S_{DS}I_pW_p \left[\frac{H_f}{R_\mu} \right] \left[\frac{C_{AR}}{R_{po}} \right] = 0.4(1.2)(1.0)(W_p) \left[\frac{2.52}{1.48} \right] \left[\frac{1.4}{1.5} \right] = 0.762W_p \quad (\text{controlling equation})$$

$$F_{p,max} = 1.6S_{DS}I_pW_p = 1.6(1.2)(1.0)(W_p) = 1.92W_p$$

$$F_{p,min} = 0.3S_{DS}I_pW_p = 0.3(1.2)(1.0)(W_p) = 0.360W_p$$

$$F_{p,ves} = 0.762W_p = 0.762(5,000 \text{ lb}) = 3,808 \text{ lb} \quad (\text{controlling seismic design force})$$



Chapter 8 - Nonstructural Component Example: HVAC Fan Unit Support

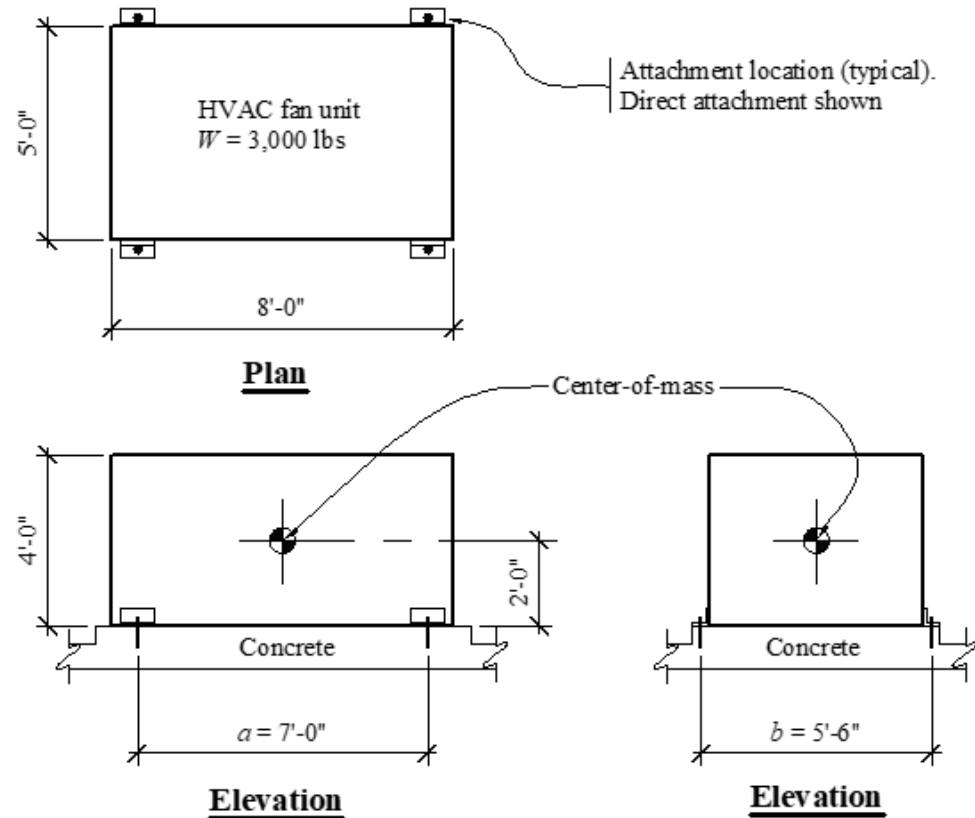

HVAC Fan Unit

Topics Covered

- **Case 1:** Direct attachment to the structure using cast-in place anchors
- **Case 2:** Support on vibration isolation springs that are attached to the slab post-installed expansion anchors.

Organization and Presentation of the Design Example Chapters

Outline of the 2020 *Design Examples* Chapters

- Chapter 1: Introduction
- Chapter 2: Fundamentals
- Chapter 3: Earthquake Ground Motions
- Chapter 4: Ductile Coupled Reinforced Concrete Shear Walls
- Chapter 5: Coupled Composite Plate Shear Walls/Concrete Filled
- Chapter 6: Three-Story Cross-Laminated Timber (CLT) Shear Wall
- Chapter 7: Horizontal Diaphragm Design
- Chapter 8: Nonstructural Components



FEMA



Building Seismic
Safety Council



How to Use the 2015 and 2020 *Design Examples* Together

- Both the 2015 and 2020 *Design Examples* are intended to be used together.
- The 2020 *Design Examples* cover major changes and new seismic force-resisting systems, but the 2015 *Design Examples* still apply in many situations.



FEMA

Building Seismic Safety Council



How to Use the 2015 and 2020 *Design Examples* Together

Topic	2015 <i>Design Examples</i> and ASCE/SEI 7-16	2020 <i>Design Examples</i> and ASCE/SEI 7-22
Fundamentals	Chapter 2 – Summary of fundamentals of earthquake engineering	Chapter 2 – Summary of fundamentals of earthquake engineering, updated from 2015 <i>Design Examples</i> .
Seismic Resilience	Not covered in 2015 <i>Design Examples</i> . <u>Use 2020 <i>Design Examples</i>.</u>	Section 2.7 – Summarizes application of resilience design to the <i>NEHRP Provisions</i> and includes a CLT case study.
Earthquake Ground Motion	Chapter 3 – Provides basis for Risk Targeted design maps, discusses hazard assessment, site specific spectra, and ground motion selection and scaling. <u>Selection and scaling discussion are still generally applicable with ASCE/SEI 7-22.</u> Use 2020 <i>Design Examples</i> otherwise.	Chapter 3 – Summarizes basis for new design maps, addition of more site classes, major update from two-period spectra to multi-period spectra, and update on vertical ground motion.
Linear Analysis	Chapter 4 – Design examples with equivalent lateral force procedure, modal response spectrum analysis, and new linear response history analysis. <u>Applicable with ASCE/SEI 7-22.</u>	Not covered in 2020 <i>Design Examples</i> . See Section 1.4 of this Chapter on relaxation of modal response spectrum analysis requirements.
Nonlinear Response History Analysis (NRHA)	Chapter 5 – Design example using NRHA for a tall reinforced concrete shear wall building. <u>Applicable with ASCE/SEI 7-22.</u>	Not covered in 2020 <i>Design Examples</i> .
Diaphragm Analysis	Chapter 6 – Design examples comparing traditional and new alternate methods. <u>Use the 2020 <i>Design Examples</i>.</u>	Chapter 7 – Design examples showing all diaphragm analysis methods including new methods introduced with the 2020 <i>NEHRP Provisions</i> . Diaphragm design for precast diaphragms has been moved out of ASCE/SEI 7-22 to ACI publications, and this is discussed.



How to Use the 2015 and 2020 *Design Examples* Together

Topic	2015 <i>Design Examples</i> and ASCE/SEI 7-16	2020 <i>Design Examples</i> and ASCE/SEI 7-22
Foundation and Liquefaction	Chapter 7 – Design examples for shallow and deep foundations and for foundations on liquefiable soil. <u>Applicable with ASCE/SEI 7-22.</u>	Not covered in 2020 <i>Design Examples</i> .
Soil-Structure Interaction (SSI)	Chapter 8 – Design example of a four-story reinforced concrete shear wall building with and without SSI. <u>Applicable with ASCE/SEI 7-22.</u>	No examples in 2020 <i>Design Examples</i> . See Section 1.4 of this Chapter for discussion on changes to SSI provisions in ASCE/SEI 7-22.
Structural Steel	Chapter 9 – Design examples for a high-bay warehouse with an ordinary concentric braced frame and an intermediate moment frame and for an office building with a special steel moment frame and a special concentric braced frame. <u>Applicable with ASCE/SEI 7-22.</u>	Not covered in 2020 <i>Design Examples</i> .
Reinforced Concrete	Chapter 10 – Design examples for an intermediate moment frame, a special moment frame, and special concrete shear walls. <u>Applicable with ASCE/SEI 7-22.</u>	Chapter 4 – Design example for a new reinforced concrete ductile coupled wall.
Precast Concrete	Chapter 11 – Design examples for precast diaphragms, intermediate precast concrete shear walls, tilt-up concrete, and precast special moment frame. <u>Applicable with ASCE/SEI 7-22.</u>	Not covered in 2020 <i>Design Examples</i> .
Composite Steel and Concrete	Chapter 12 – Design example of composite partially restrained moment frame. <u>Applicable with ASCE/SEI 7-22.</u>	Chapter 5 – Design example for a new steel and concrete coupled composite plate shear walls.



How to Use the 2015 and 2020 *Design Examples* Together

Topic	2015 <i>Design Examples</i> and ASCE/SEI 7-16	2020 <i>Design Examples</i> and ASCE/SEI 7-22
Masonry	Chapter 13 – Design examples for two reinforced masonry bearing wall buildings. <u>Applicable with ASCE/SEI 7-22.</u>	Not covered in 2020 <i>Design Examples</i> .
Wood	Chapter 14 – Design examples for an apartment, wood roof diaphragm and roof-to-wall anchorage in a masonry building. <u>Use the 2020 <i>Design Examples</i> for wood diaphragms.</u>	Chapter 6 – Design example for new cross-laminated timber shear wall system.
Seismic Isolation	Chapter 15 – Design example of an essential facility with lead rubber bearings using the significantly revised isolation provisions. <u>Applicable with ASCE/SEI 7-22.</u>	Not covered in 2020 <i>Design Examples</i> .
Damping	Chapter 16 – Design example of fluid viscous dampers in a steel moment frame building. <u>Applicable with ASCE/SEI 7-22.</u>	Not covered in 2020 <i>Design Examples</i> .
Nonbuilding Structures	Chapter 17 – Design examples for pipe racks, industrial storage rack, power generating plant, pier, storage tanks, and tall vertical storage vessel. <u>Applicable with ASCE/SEI 7-22.</u>	No examples in 2020 <i>Design Examples</i> . See Section 1.4 for discussion on changes to nonbuilding structures in ASCE/SEI 7-22.
Nonstructural Components	Chapter 18 – Design examples for precast cladding, egress stair, roof fan anchorage, piping system, and elevated vessel. <u>Use 2020 <i>Design Examples</i>.</u>	Chapter 8 – Background on development of new design equations and other changes, plus design examples for precast cladding, egress stair, roof fan anchorage, piping system, and elevated vessel.



Presentation Techniques in the 2020 *Design Examples*

Reference to ASCE/SEI 7-22

For ease of reader use, the 2020 *Design Examples* typically reference ASCE/SEI 7-22 sections and equations rather than the 2020 *NEHRP Provisions*. However, at the time of completion of writing the 2020 *Design Examples* in the summer of 2021, ASCE/SEI 7-22 had not been finalized or published. Publication was expected in December 2022. The June 17, 2021, draft of ASCE/SEI 7-22 issued for public comment was used as the reference document for ASCE/SEI 7-22. At that time, all major proposals from the ASCE committee responsible for the standard had been incorporated, but public review remained. This may lead to changes in the final published version of ASCE/SEI 7-22. As such, when that published version is available, the reader of this 2020 *Design Examples* should look at the sections in the published version where revisions from ASCE/SEI 7-16 are indicated to determine whether there are meaningful differences.



Presentation Techniques in the 2020 Design Examples

- Free-body diagrams are used.
- A worked-out example of the calculations is typically shown in detail only once. Summary tables then show the results for the other similar components.
- The focus is on key selected items in each example to keep the document size manageable. Not all necessary items that would need to be checked or designed are shown. In many cases, a list of these additional items is provided.
- Changes between the NEHRP provisions and ASCE/SEI 7-22 are flagged:

Changes Between the NEHRP Provisions and ASCE/SEI 7-22

Equation 13.3-6 in the 2020 NEHRP Provisions was modified for ASCE/SEI 7-22, by adding I_e into the denominator to better estimate the structure ductility.

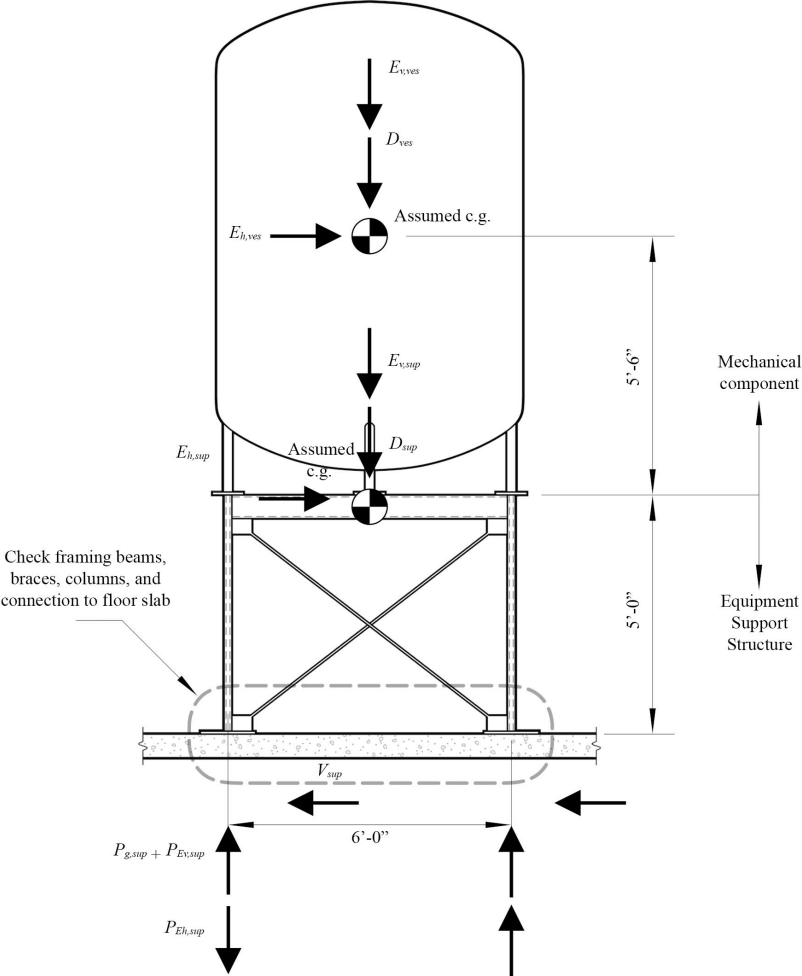

BSSC NEHRP Webinar Training: nibs.org/events/nehrrp-webinar-series

- *Introduction to the 2020 NEHRP Provisions Design Examples:* Bret Lizundia and Mai Tong
- *Fundamentals of Earthquake Engineering:* James Harris
- *Diaphragm Seismic Design Part 1 and Part 2:* Kelly Cobeen
- *Ductile Coupled Reinforced Concrete Shear Walls:* S.K. Ghosh
- *Nonstructural Components Part 1 and Part 2:* Bret Lizundia
- *Fundamentals and Evolution of U.S. Seismic Design Values and the 2018 Update of the USGS National Seismic Hazard Model:* Sanaz Rezaeian and Ronald Hamburger
- *Multi-Period Response Spectra Provisions, Other Changes to Ground Motion Provisions, and Dissection of Example Changes to the Ground Motion Values:* Charles Kircher, C.B. Crouse, and Nicolas Luco
- *Cross-Laminated Timber Shear Wall Design and Resilience-Based Design:* M. Omar Amini, David Bonowitz, and Philip Line
- *Coupled Composite Plate Shear Walls / Concrete Filled:* Soheil Shafaei and Amit Varma



FEMA



Building Seismic
Safety Council



Questions?



FEMA



Building Seismic
Safety Council



DISCLAIMER

- NOTICE: Any opinions, findings, conclusions, or recommendations expressed in this publication do not necessarily reflect the views of the Federal Emergency Management Agency. Additionally, neither FEMA nor any of its employees make any warranty, expressed or implied, nor assume any legal liability or responsibility for the accuracy, completeness, or usefulness of any information, product or process included in this publication.
- The opinions expressed herein regarding the requirements of the *NEHRP Recommended Seismic Provisions*, the referenced standards, and the building codes are not to be used for design purposes. Rather the user should consult the jurisdiction's building official who has the authority to render interpretation of the code.
- This training material presentation is intended to remain complete in its entirety even if used by other presenters. While the training material could be tailored for use in other presentations, we caution users to account for issues of completeness and interpretation if only part of the material is used. We also strongly suggest users give proper credit/citation to this presentation and its author.



FEMA



Building Seismic
Safety Council



Chapter 2 (Sections 2.1 to 2.6) Fundamentals

2020 NEHRP Provisions Training Materials
James Harris, J. R. Harris & Company



EMA



Building Seismic
Safety Council

| BSSC



Overview

- **Fundamental Concepts**
- Ground Motions and Their Effects
- Structural Dynamics of Linear SDOF Systems
- Response Spectra
- Structural Dynamics of Simple MDOF Systems
- Inelastic Behavior
- Structural Design



FEMA



Building Seismic
Safety Council



The consists of text outlining the key topics in this presentation.

This slide provides an overview of the topics presented in this slide set.

Fundamental Concepts (1)

- Ordinarily, a large earthquake produces the most severe loading that a building is expected to survive. The probability that failure will occur is very real and is greater than for other loading phenomena. Also, in the case of earthquakes, the definition of failure is altered to permit certain types of behavior and damage that are considered unacceptable in relation to the effects of other phenomena.
- The levels of uncertainty are much greater than those encountered in the design of structures to resist other phenomena. The high uncertainty applies both to knowledge of the loading function and to the resistance properties of the materials, members, and systems.
- The details of construction are very important because flaws of no apparent consequence often will cause systematic and unacceptable damage simply because the earthquake loading is so severe and an extended range of behavior is permitted.



FEMA



Building Seismic
Safety Council



Slide contains text taken from Chapter 2 of FEMA P-1051 discussing probabilities and uncertainties of failure due to earthquakes.

These bullet items are taken directly from the text of Chapter 2 of FEMA P-1051.

Fundamental Concepts (2)

- During an earthquake the ground shakes violently in all directions. Buildings respond to the shaking by vibration, and the movements caused by the vibration and the ground motion induce inertial forces throughout the structure.
- In most parts of the country the inertial forces are so large that it is not economical to design a building to resist the forces elastically. Thus, inelastic behavior is necessary, and structures must be detailed to survive several cycles of inelastic behavior during an earthquake.
- The structural analysis that is required to exactly account for the dynamic loading and the inelastic response is quite complex and is too cumbersome for most projects. The *NEHRP Provisions* and ASCE 7 provide simplified approximate analysis approaches that overcome these difficulties.
- Rules for detailing structures for seismic resistance are provided by standards such as ACI 318 and the AISC Specification and the AISC *Seismic Provisions*



FEMA



Building Seismic
Safety Council



This slide contains text with additional text discussing fundamental concepts of seismic design.

Fundamental concepts, continued.

Overview

- Fundamental Concepts
- **Ground Motions and Their Effects**
- Structural Dynamics of Linear SDOF Systems
- Response Spectra
- Structural Dynamics of Simple MDOF Systems
- Inelastic Behavior
- Structural Design



FEMA



Building Seismic
Safety Council



Slide contains text of an overview of the topics presented in this slide set.

This slide provides an overview of the topics presented in this slide set.

Seismic Activity on Earth

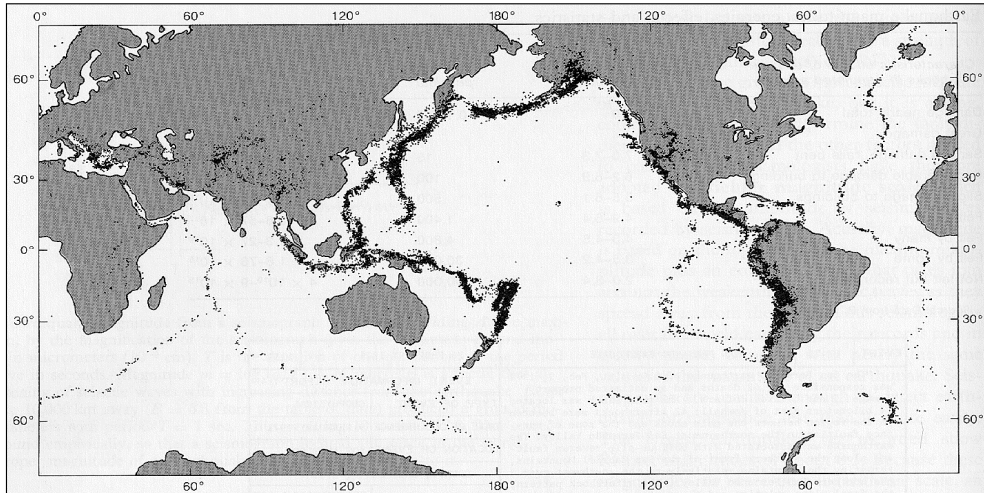

FEMA

Building Seismic
Safety Council



6

This slide contains an image where earthquakes have occurred historically in the world.

This slide shows a series of dots where earthquakes have occurred historically in the world. As may be seen, the dots are not randomly oriented, but instead for distinct patterns. It has been determined that the dot patterns outline the boundaries of tectonic “plates” that form the crust of the earth. The San Andreas fault in western California lies along one of the plate boundaries. Note also the heavy concentration of dots along the west coast of South America, and along the north-western Pacific coast, and the Aleutian Island Chain. Most of the historic “great earthquakes” have occurred in these locations.

Note the scarcity of dots in the central and eastern U.S. Earthquakes are rare here, but large earthquakes have occurred in central Missouri and in South Carolina.

Tectonic Plates

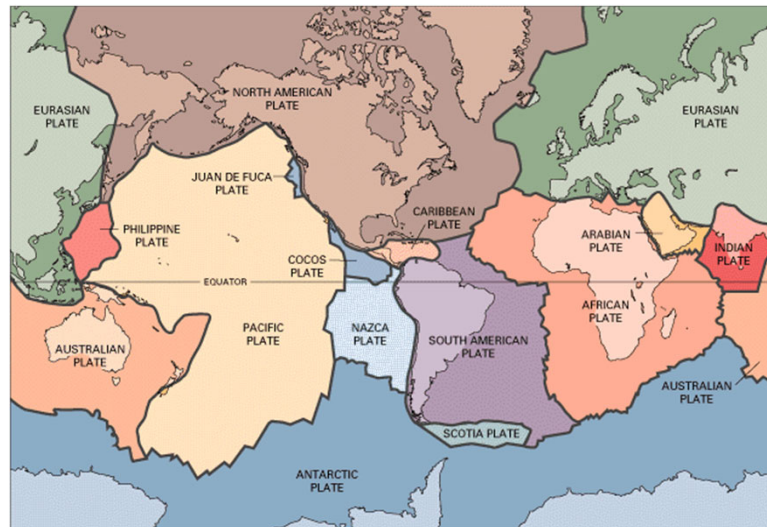

FEMA

Building Seismic
Safety Council



This figure shows an image of the tectonic plates and the plate names on earth.

This slide shows the tectonic plates and the plate names. Heavy black lines mark the main plate boundaries.

Section of Earth Crust at Ocean Rift Valley

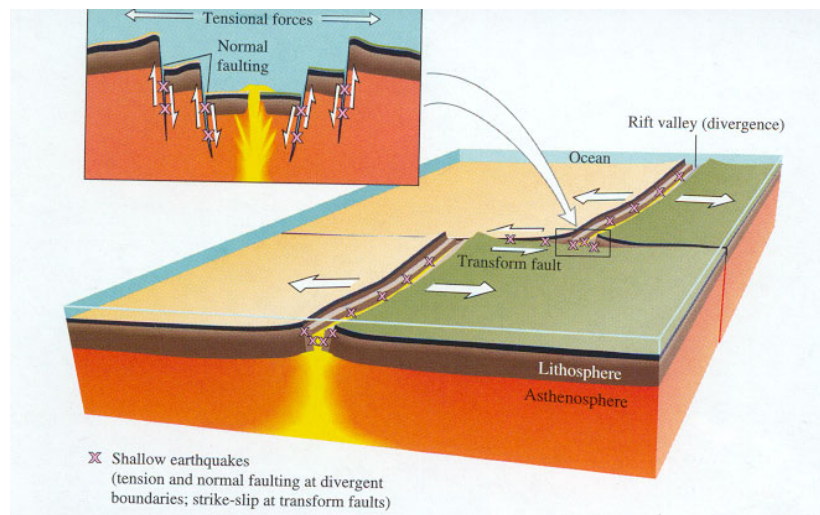

FEMA



Building Seismic
Safety Council



From E.V. Leyendecker, USGS

8

An image of a section of the earth's crust and the driving mechanism for plate movement in ocean rift valleys.

This slide, from Bolt, shows a section of the Earth's crust, and the driving mechanism for plate movement in ocean rift valleys.

Section of Earth Crust at Plate Boundary (Subduction Zone)

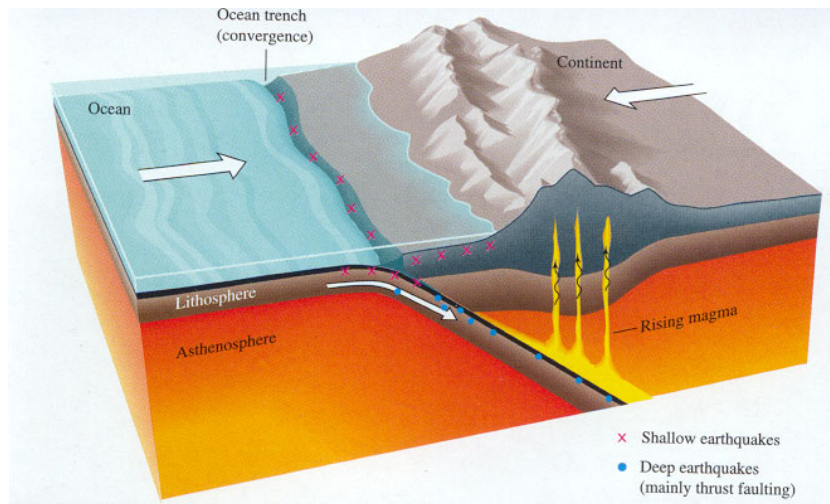

From E.V. Leyendecker, USGS



FEMA



Building Seismic
Safety Council



This slide contains an image showing the subduction type mechanism.

If the plates continue to diverge at the ridges, the surface of the earth would have to grow (or buckle) unless there were some mechanism to return some cool rock into the *asthenosphere*. This slide, also from Bolt, shows how the plate submerges (or subducts) under the continental shelf at the plate boundary. The sudden release of frictional forces that develop at this interface are a major source of earthquakes. Volcanic activity is also a source of earthquakes, but the resulting ground motions are usually not as severe. A note about the buckling: this does occur where two continental plates converge, such as the boundary between India and Asia; the result is the highest mountain chain on earth.

Fault Features

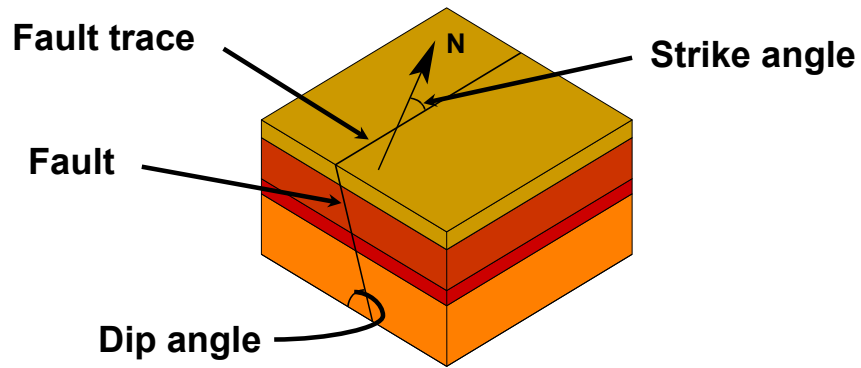

FEMA



Building Seismic
Safety Council



From S.T. Algermissen, USGS

10

This slide contains an image highlighting fault and their features.

Zones of relative weakness in the Earth's crust are called *faults*. After the stresses build up in the rock, one particular area will rupture with relative movement. Define a few key terms for description of faults.

Faults and Fault Rupture

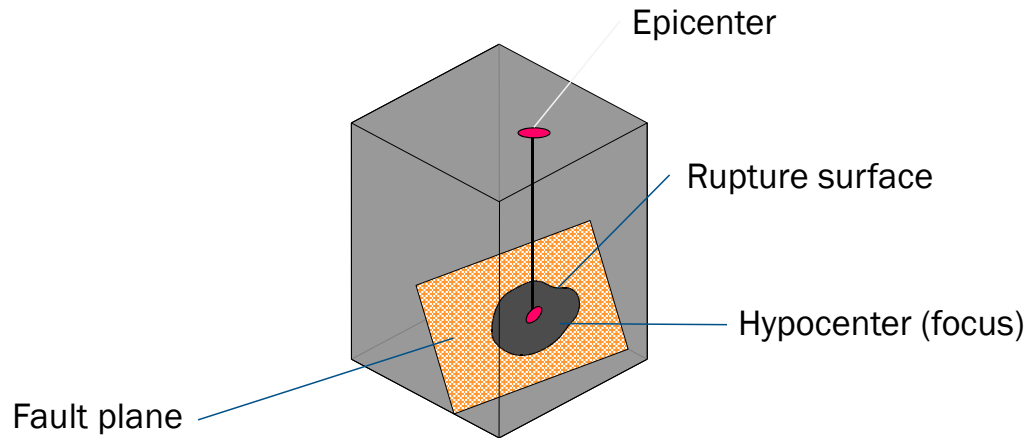

FEMA



Building Seismic
Safety Council



From S.T. Algermissen, USGS

11

This slide contains an image highlighting fault plane, hypocenter, rupture surface, and epicenter of an earthquake.

When an earthquake occurs the rupture spreads over a portion of the fault. The point where the rupture begins is called the *focus* or *hypocenter*. The rupture will then propagate at a very high speed, forming a *fault plane*. The vertical projection of the focus to the surface is the *epicenter*. For shallow earthquakes, the fault plate may intersect the surface, causing a visible *fault rupture* and possible *escarpment*. For some deeper earthquakes, the fault may not be seen at the surface. These are called *blind faults*.

Types of Faults

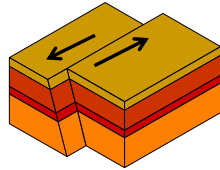

Strike Slip
(Left Lateral)

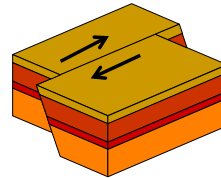

Strike Slip
(Right Lateral)

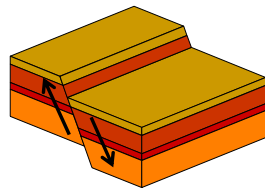

Normal

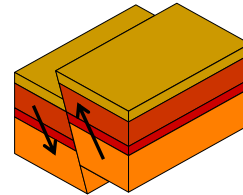

Reverse (Thrust)



FEMA



Building Seismic
Safety Council



From S.T. Algermissen, USGS

12

Contains images of different fault types.

These are the various types of faults representing either lateral or vertical movement. The fault plane may be vertical or skewed as shown. For *strike slip* faults, the type designation comes from the movement of one block relative to an observer. If the observer is standing on one of the blocks looking across the fault and the far block moves to the observer's right, it is a *right lateral* fault. For a *normal fault*, the two blocks move away from each other (extensional). For a *thrust fault*, the blocks are moving towards each other (compressional). The visible wall formed from the movement is called an *escarpment*. Of course, the fault may be a combined strike-slip or normal/reverse fault.

Seismic Wave Forms (Body Waves)

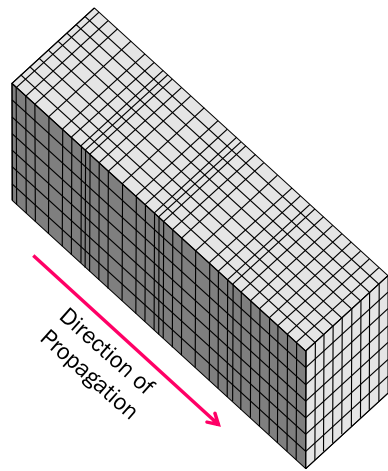

Compression Wave (P Wave)

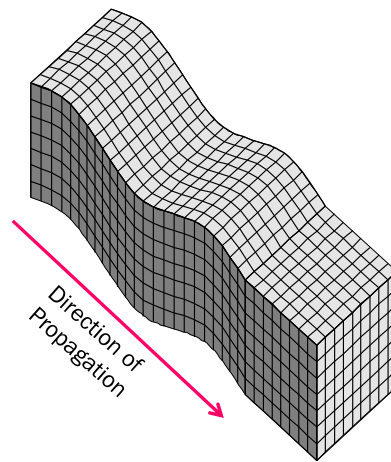

Shear Wave (S Wave)



FEMA

Building Seismic
Safety Council



This slide contains two images, one illustrating a compression wave (p wave), and the other illustrating a shear wave (s wave).

The energy released during an earthquake propagates in waves. The two types of waves are *body waves* and *surface waves*. The principal body waves are the *Compression (P) wave* and the *Shear (S) wave*. Compression and shear waves move on a spherical front. Sometimes the compression waves are called “push-pull” as they work like an accordion. Compression waves travel the fastest of all waves (4.8 km/second in granite), and they travel through both solids and liquids. Shear waves move from side to side. Because fluids (e.g. water and magma) have no shear stiffness, shear waves do not pass through. Shear waves are the second wave type to arrive, moving at about 3.0 km/second.

Seismic Wave Forms (Surface Waves)

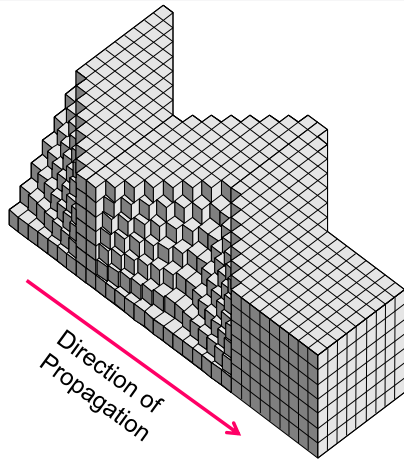

Love Wave

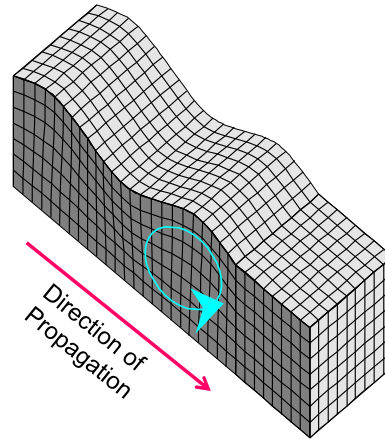

Rayleigh Wave



FEMA



Building Seismic
Safety Council



This slide contains two images, one showing a love wave, the other showing a Rayleigh wave.

The next waves to arrive are the surface waves. The two main types are *Love* waves and *Rayleigh* waves. These waves have a somewhat longer period than P or S waves.

Arrival of Seismic Waves

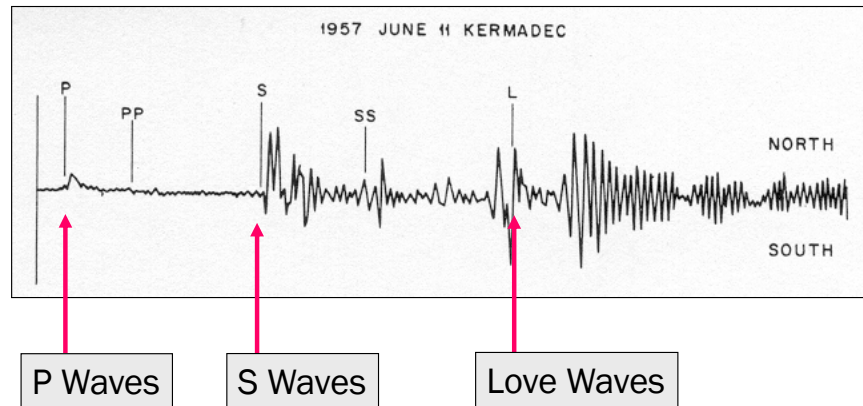

FEMA

Building Seismic
Safety Council



Image from USGS

15

This slide contains an image of an earthquake recording, showing the sequential arrival of P, S, and Love waves.

This recording shows the sequential arrival of P, S, and Love waves. With travel speeds of the various waves known, this type of diagram can be used to estimate the distance to the wave source.

Effects of Earthquakes

- Ground Failure
 - Rupture
 - Landslide
 - Liquefaction
 - Lateral Spreading
- Tsunami
- Seiche
- Ground Shaking



FEMA



Building Seismic
Safety Council



This slide contains text of hazards related to earthquakes

There are numerous hazards related to earthquakes. While ground shaking is emphasized in this topic, it is not necessarily the greatest hazard. Tsunamis in December 2004 and March 2011 were incredibly destructive. Ground shaking is responsible for several of the other effects: landslide, liquefaction, lateral spreading and seiche, which is oscillation of a body of water with effects similar to tsunami, but a completely different cause.

Recorded Ground Motions

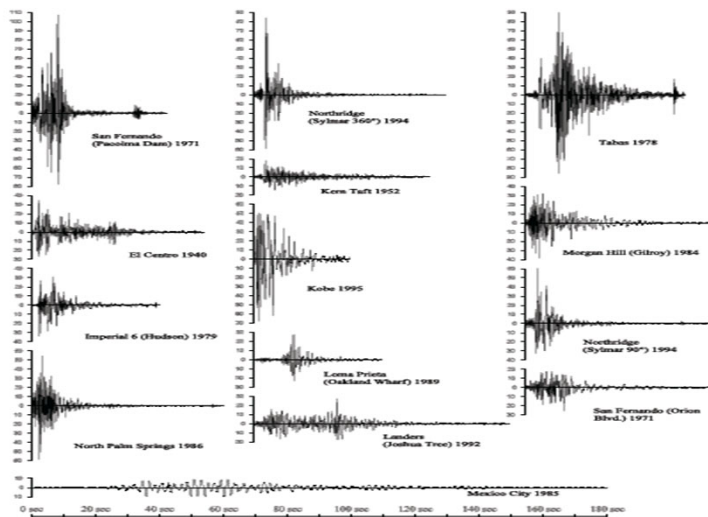

From Housner, G., and Jennings, P. (1982). *Earthquake Design Criteria*, EERI.



FEMA

Building Seismic Safety Council



Slide contains images of recorded ground motions.

In most seismically active areas of the world seismologists have laid out vast instrument arrays that can capture the ground motion in terms of a recording of ground acceleration vs time. Usually, each instrument can record two horizontal components and one vertical component at the same station.

This slide shows some of the horizontal component recordings for a variety of earthquakes worldwide. All of the recordings are of the same horizontal (time) and vertical (acceleration) scale, with the maximum acceleration approximately 1.0 g. The character of the ground motion recording depends on many factors, including the soil type, the distance from the epicenter, and the direction of travel of seismic waves. The 1984 Mexico City Earthquake, shown at the bottom, is noted for its long duration and low frequency. This is characteristic of recordings on very soft soil, taken at some distance from the epicenter.

Shaking at the Holiday Inn During the 1971 San Fernando Valley EQ

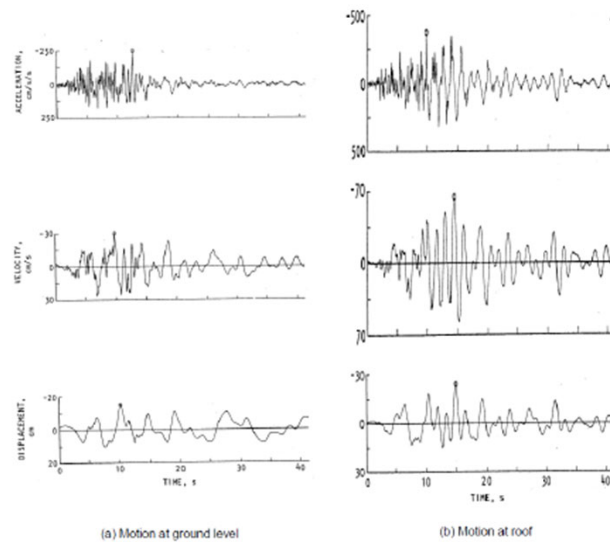

From Housner, G., and Jennings, P. (1982). *Earthquake Design Criteria*, EERI.



FEMA



Building Seismic Safety Council



Slide contains images of records of the 1971 San Fernando Valley earthquake at a Holiday Inn.

Holiday Inn ground and building roof motion during the M6.4 1971 San Fernando earthquake: (a) north-south ground acceleration, velocity, and displacement and (b) north-south roof acceleration, velocity, and displacement (Housner and Jennings, 1982). The Holiday Inn, a 7-story, reinforced concrete frame building, was approximately 5 miles from the closest portion of the causative fault. The recorded building motions enabled an analysis to be made of the stresses and strains in the structure during the earthquake.

Overview

- Fundamental Concepts
- Ground Motions and Their Effects
- **Structural Dynamics of Linear SDOF Systems**
- **Response Spectra**
- Structural Dynamics of Simple MDOF Systems
- Inelastic Behavior
- Structural Design



FEMA



Building Seismic
Safety Council



Slide contains text providing an overview of the topics presented in this slide set.

This slide provides an overview of the topics presented in this slide set.

NEHRP (2009) Seismic Hazard Maps

- Probabilistic / Deterministic (Separate Maps)
- Uniform Risk (Separate Maps)
- Spectral Contours (PGA, 0.1, 0.2 sec)
- 5 % Damping
- Site Class B/C Boundary
- Maximum Direction Values

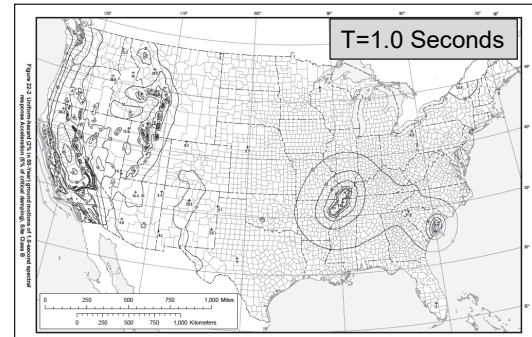
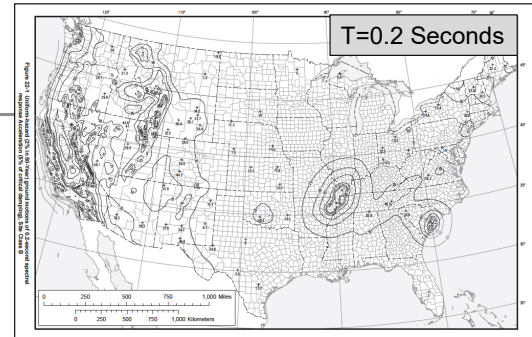

From 2009 *NEHRP Provisions*



FEMA

Building Seismic
Safety Council



Slide contains two images of maps of the USA, showing the spectral accelerations for 0.2 second structures and 1.0 second structures.

In the 2009 *NEHRP Provisions* and in ASCE 7-05 and -10, ground motion is represented by a quantity called Spectral Acceleration, which represents the total expected acceleration that a mass of a Single Degree of Freedom Structure (SDOF) would feel at a given location in the country. Chapter 3 of P-751 and Topic 3 of this slide series discusses the maps in some detail. The point made here is that the spectral accelerations are Response Spectrum ordinates, and that some grasp of structural dynamics is needed to understand what a response spectrum is.

The 2020 *NEHRP Provisions* establish spectral accelerations at 22 periods of vibrations, which will be shown following the introduction of the response spectrum concept.

Structural Dynamics of SDOF Systems

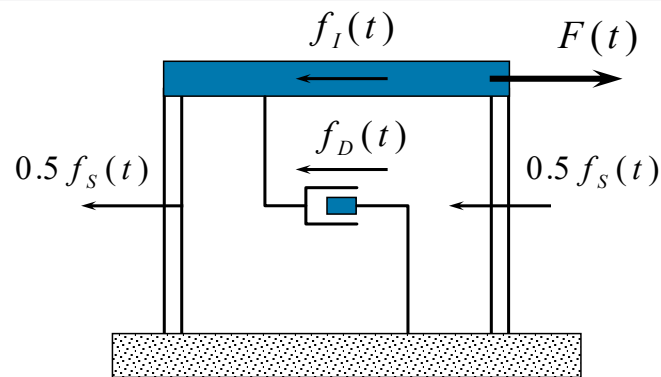

$$f_I(t) + f_D(t) + f_S(t) = F(t)$$

$$m \ddot{u}(t) + c \dot{u}(t) + k u(t) = F(t)$$

Image from Finley Charney



FEMA



Building Seismic Safety Council



This slide shows an image of an idealized and simple structure to demonstrate a dynamic dashpot system. An equation underneath shows the equation of dynamic equilibrium.

This slide shows a simple, highly idealized structure. In this structure the columns are flexible, and the beam is rigid. All of the mass of the structure is assumed to reside in the beam. A (fictitious) dashpot is shown for the purpose of providing some damping in the system. The properties of the system are the stiffness, k , the damping constant, c , and the mass, m . A time-varying horizontal load $F(t)$ is applied to the mass, and the displacement history $u(t)$ is to be obtained. The solution is obtained by solving the equation of dynamic equilibrium shown at the bottom of the slide, which represents a time-wise balance of inertial, damping, elastic, and applied forces.

Mass

- Includes all dead weight of structure
- May include some live load
- Has units of force/acceleration

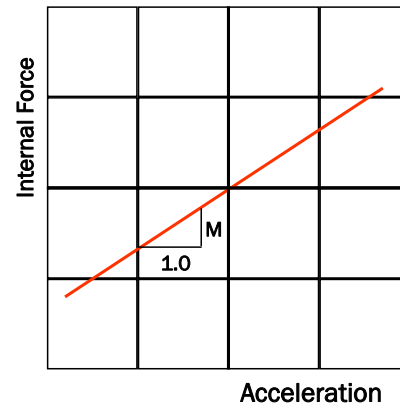
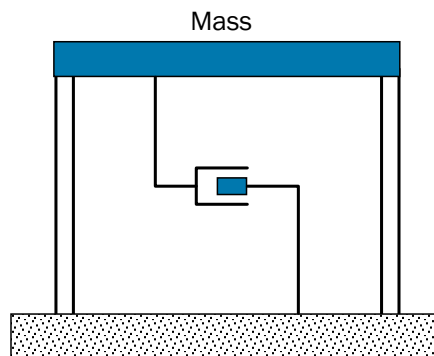

FEMA



Building Seismic
Safety Council



Image from Finley Charney

22

This slide is focused on the mass of the dynamic system, and it contains text overviewing its parameters. An image on the left points out the mass in the simplified and idealized structure. The graph on the right shows the relationship between acceleration and force of mass.

The mass, m , of the system represents all of the weight of the structure and its fixed attachments. It may include some live load if it can be assumed that the live load (e.g. storage loads) will move in phase with the structure when it vibrates. Note that the units of force/acceleration.

Linear Viscous Damping

- In absence of dampers, is called inherent damping
- Usually represented by linear viscous dashpot
- Has units of force/velocity

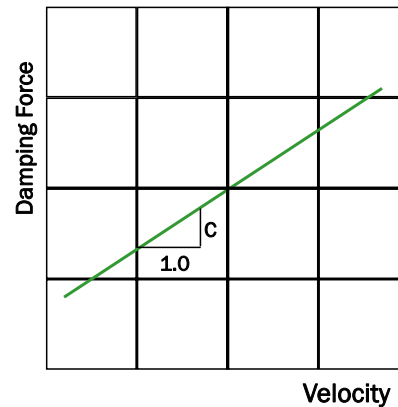
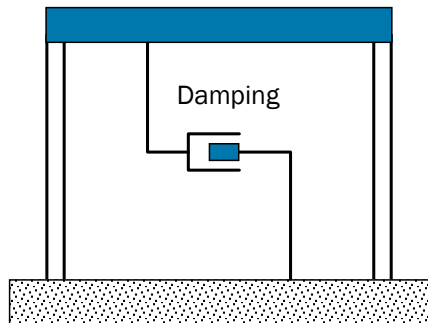

Image from Finley Charney



FEMA



Building Seismic
Safety Council



This slide is focused on the damping of the dynamic system, and it contains text overviewing its parameters. An image on the left points out the damping in the simplified and idealizes structure. The graph on right illustrates the relationship between velocity and force for damping.

Experience shows that a system set in motion and allowed to vibrate freely will eventually come to rest. This is due to damping in the system, which is a means of converting energy into heat, which is then irrecoverably dissipated. In real structures, damping occurs due to a variety of reasons, ranging from material damping, to friction in connections, and friction in nonstructural components and contents. In structural dynamics, it is convenient to represent the damping as a linear viscous “dashpot” for which the resistance is proportional to the deformational velocity in the dashpot (which is the same as the velocity of the mass relative to the base of the structure). The damping constant, c , is impossible to specify directly, and instead, a damping ratio is used in computations (as shown later).

Damping and Energy Dissipation

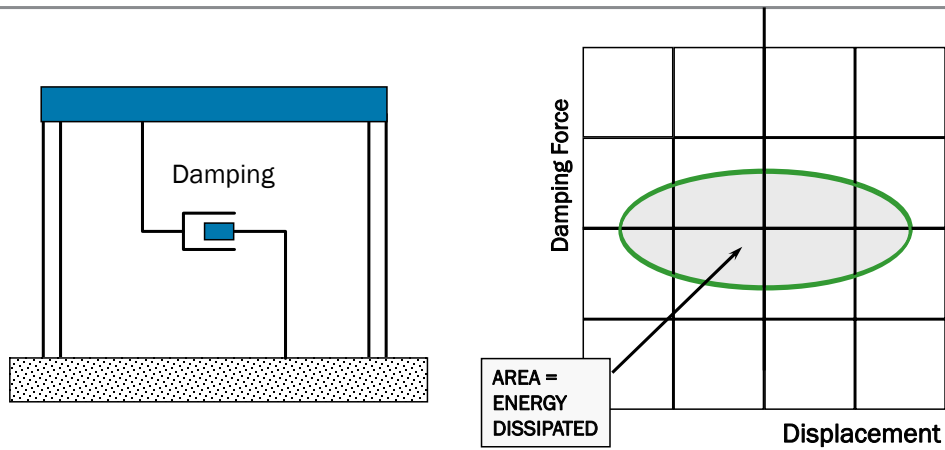

Damping vs displacement response is elliptical for linear viscous damper.



FEMA

Building Seismic
Safety Council



Image from Finley Charney

24

This slide is focused on the damping of the dynamic system, and it shows how energy is dissipated. An image on the left points out the damping in the simplified and idealized structure. The graph on right illustrates the relationship between energy dissipated and the area of the force displacement plot.

When the damping force is plotted vs displacement, an elliptical hysteresis occurs (when the system is under steady state vibration). The area within the hysteresis curve represent the energy dissipated per cycle.

Elastic Stiffness

- Includes all structural members
- May include some “seismically nonstructural” members
- Requires careful mathematical modelling
- Has units of force/displacement

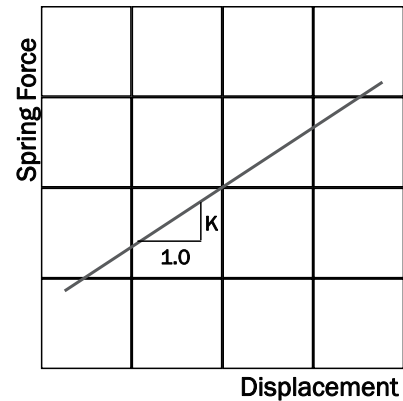
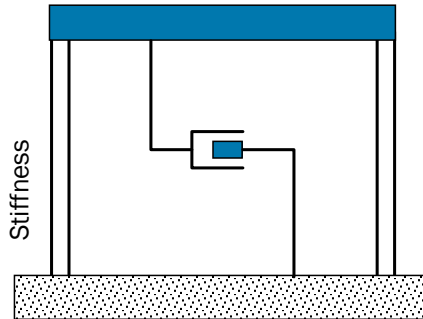

Image from Finley Charney



FEMA

Building Seismic Safety Council



This slide is focused on the stiffness of the dynamic system, it and contains text overviewing its parameters. An image on the left points out the stiffness in the simplified and idealizes structure. The graph on right shows the relationship between displacement and force of stiffness.

The stiffness, k , of the structure is described in this slide. For real structures it is difficult to obtain an exact value of k because of a variety of uncertainties. For example, in concrete structures, cracking has a large influence on stiffness, but the amount of cracking due to environmental and service loads can not be predicted with any precision. Similarly, in steel structures, it is difficult to quantify the effect of connection stiffness, or the influence of partially composite slabs.

Inelastic Behavior

- Is almost always nonlinear in real seismic response
- Nonlinearity is implicitly handled by codes
- Explicit modelling of nonlinear effects is possible (but very difficult)

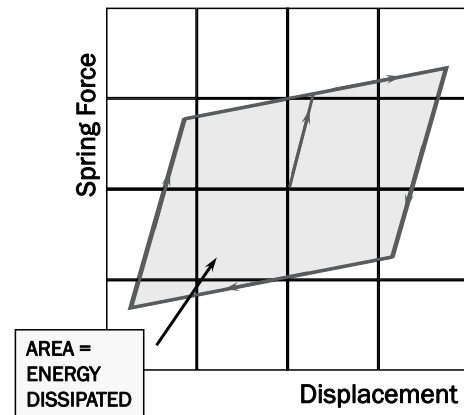
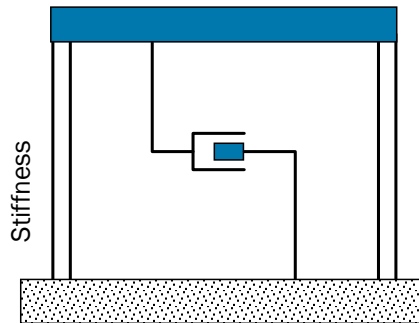

FEMA

Building Seismic Safety Council



Image from Finley Charney

26

This slide is focused on the stiffness of the dynamic system, and it shows how energy is dissipated. An image on the left points out the stiffness in the simplified and idealized structure. The graph on right illustrates the relationship between energy dissipated and the area of the force displacement plot.

As mentioned earlier, we can generally not afford to design structures to remain elastic during major earthquakes. Thus, we must allow the structure to deform inelastically in a controlled manner. Like damping, inelastic behavior produces an irrecoverable energy dissipation, shown here as the area enclosed within the cyclic force-deformation plot.

While it is possible to perform a nonlinear analysis, this is quite difficult, and is done only in special circumstances. The vast majority of analysis is performed using linear procedures which implicitly account for the inelastic behavior in the structure.

Undamped Free Vibration

Equation of motion: $m \ddot{u}(t) + k u(t) = 0$

Initial conditions: $\dot{u}_0 \quad u_0$

Assume: $u(t) = A \sin(\omega t) + B \cos(\omega t)$

Solution: $A = \frac{\dot{u}_0}{\omega} \quad B = u_0 \quad \omega = \sqrt{\frac{k}{m}}$

$$u(t) = \frac{\dot{u}_0}{\omega} \sin(\omega t) + u_0 \cos(\omega t)$$



FEMA



Building Seismic
Safety Council



Slide contains equations of undamped free vibration of a structure.

It is beyond the scope of this topic to present the details of computing the dynamic response. However, the computed responses of a few simple loadings will be presented to provide some needed nomenclature.

The first such loading is undamped free vibration, where the damping is assumed to be absent, and the structure is set in motion by an initial displacement and/or velocity. The response is in the form of a sine wave. The frequency of vibration, (omega) is called the circular or angular frequency, and it has units of radians/second. As can be seen, this frequency is in effect a structural property as it involves only mass and stiffness.

Undamped Free Vibration (2)

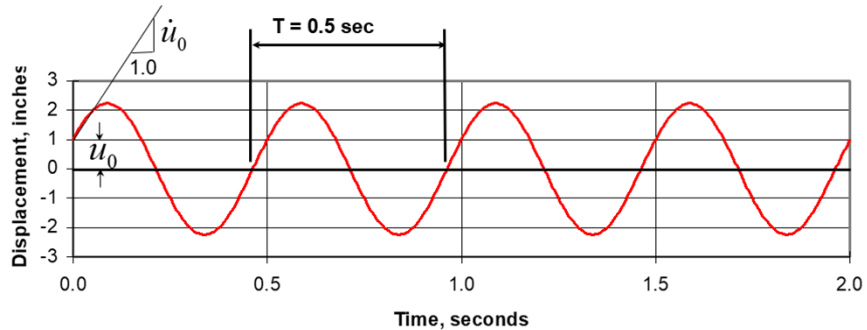

Circular Frequency
(radians/sec)

$$\omega = \sqrt{\frac{k}{m}}$$

Cyclic Frequency
(cycles/sec, Hertz)

$$f = \frac{\omega}{2\pi}$$

Period of Vibration
(sec/cycle)

$$T = \frac{1}{f} = \frac{2\pi}{\omega}$$



FEMA

Building Seismic
Safety Council



Image from Finley Charney

Slide contains an image illustrating undamped free vibration. Equations are displayed to find the circular frequency, cyclic frequency and period of vibration.

This slide shows the dynamic response of a system in undamped free vibration. In structural engineering, it is common to use the period of vibration, T , instead of circular frequency (omega) or cyclic frequency (Hz).

The proper units of period of vibration is seconds/cycle, although the word “cycle” is almost universally omitted.

Periods of Vibration of Common Structures

20-story moment resisting frame	T = 2.4 sec
10-story moment resisting frame	T = 1.3 sec
1-story moment resisting frame	T = 0.2 sec
20-story steel braced frame	T = 1.6 sec
10-story steel braced frame	T = 0.9 sec
1-story steel braced frame	T = 0.1 sec
Gravity dam	T = 0.2 sec
Suspension bridge	T = 20 sec



FEMA



Building Seismic
Safety Council



Slide shows typical periods of vibrations of common structures.

This slide shows some periods of vibration of common structures. The *Provisions* provides approximate formulas for computing period, based on material, structural system, and height.

Damped Free Vibration

Equation of motion: $m \ddot{u}(t) + c \dot{u}(t) + k u(t) = 0$

Initial conditions: $u_0 \quad \dot{u}_0$

Assume: $u(t) = e^{st}$

Solution:

$$u(t) = e^{-\xi \omega t} \left[u_0 \cos(\omega_D t) + \frac{\dot{u}_0 + \xi \omega u_0}{\omega_D} \sin(\omega_D t) \right]$$

$$\xi = \frac{c}{2m\omega} = \frac{c}{c_c}$$

$$\omega_D = \omega \sqrt{1 - \xi^2}$$



FEMA



Building Seismic
Safety Council



Slide contains equations of damped free vibration of a structure.

In this slide the equation for motion is shown for the system under damped free vibration is shown. Two important quantities result from the solution to the equation, the damping ratio (Greek letter xi), and damped frequency of vibration omega sub D. In earthquake engineering, xi is almost universally taken as 0.05, and c is then back-calculated using this value, m, and omega. For xi=0.05, there is practically no difference between the damped and undamped frequency, so the undamped value is used for convenience.

Damped Free Vibration (2)

$$\xi = \frac{c}{2m\omega} = \frac{c}{c_c} \quad c_c \text{ is the } \textit{critical damping constant}.$$

ξ is expressed as a ratio ($0.0 < \xi < 1.0$) in computations.

Sometimes ξ is expressed as a% ($0 < \xi < 100\%$).



Response of Critically Damped System, $\xi=1.0$ or 100% critical



FEMA

Building Seismic
Safety Council



Image from Finley Charney

Slide contains equations regarding damping, and a graph of a displacement vs time of a critically damped system.

The important point on this slide is the use of ξ as a ratio versus a percentage. Some computer programs require this number as input, and it is important to get the value entered correctly.

Damped Free Vibration (3)

True damping in structures is NOT viscous. However, for low damping values, viscous damping allows for linear equations and vastly simplifies the solution.

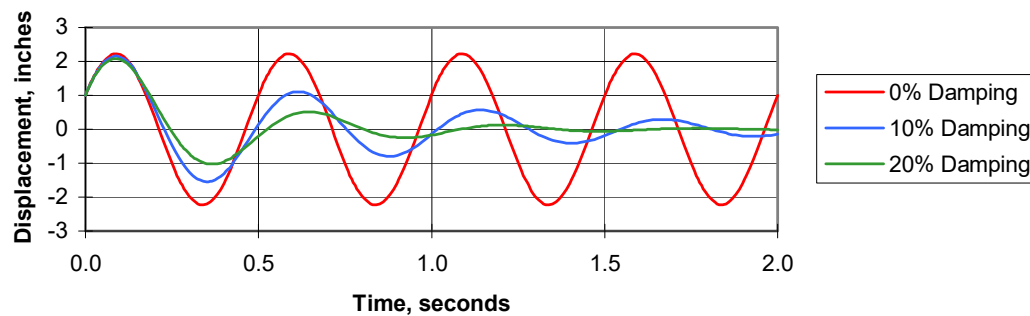

Image from Finley Charney



FEMA



Building Seismic
Safety Council



This slide contains a graph showing the effect of different percentages of damping on a displacement vs time plot.

In free vibration, damping reduces the response over time, and the greater the damping, the more rapid the decay in vibration amplitude.

Damping in Structures

Welded steel frame	$\xi = 0.010$
Bolted steel frame	$\xi = 0.020$
Uncracked prestressed concrete	$\xi = 0.015$
Uncracked reinforced concrete	$\xi = 0.020$
Cracked reinforced concrete	$\xi = 0.035$
Glued plywood shear wall	$\xi = 0.100$
Nailed plywood shear wall	$\xi = 0.150$
Damaged steel structure	$\xi = 0.050$
Damaged concrete structure	$\xi = 0.075$
Structure with added damping	$\xi = 0.250$



FEMA

Building Seismic
Safety Council



This slide contains typical damping percentages of different structures.

This slide lists some reasonable damping ratios in structures, and as can be seen the values can vary considerably. In the *Provisions*, values of damping other than 5% critical are (very approximately) accounted for in the response modification coefficient, R . Note that the seismic hazard maps are based on 5% critical damping.

Undamped Harmonic Loading and Resonance

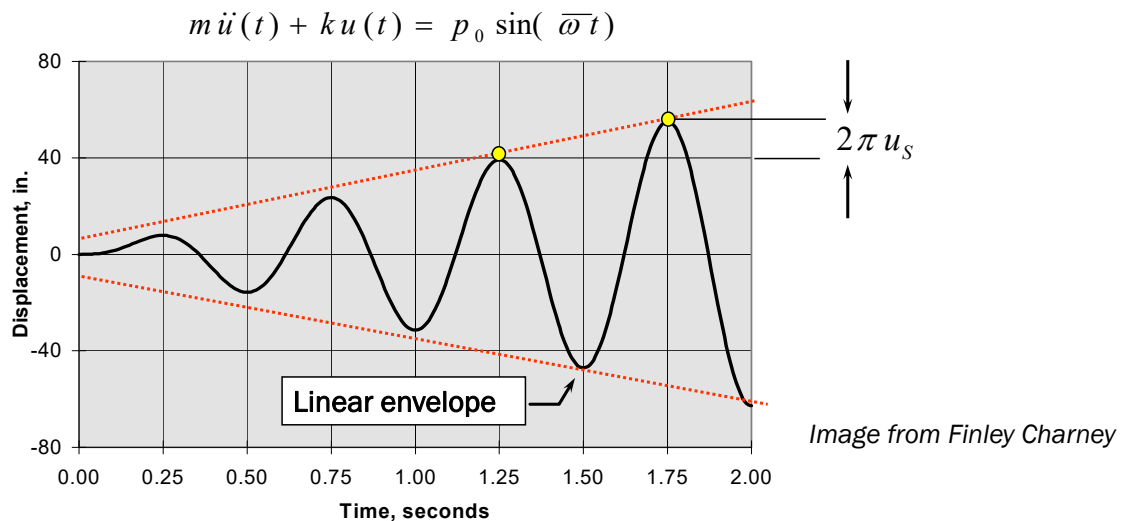

FEMA

Building Seismic
Safety Council



This slide contains an image of undamped harmonic loading and response.

When an undamped system is loaded harmonically, the response will grow without bound when the loading frequency ($\bar{\omega}$) is equal to the structure's own natural frequency. Such a phenomena is known as "resonance." An unbounded response is, of course, only mathematical because any system will become damaged and fail at some point of deformation if the system is brittle, or it will yield (changing the structure's frequency and adding damping in the form of hysteretic energy dissipation) and fall out of resonance. Nevertheless, resonance is undesirable. Unfortunately, all ground motions will contain at least one frequency which is in phase with the structure's own natural frequency, so all earthquake response is resonant. In most cases the structure will not fall out of resonance when the system yields because there is some other frequency component of the ground motion which will be in resonance with the new structural frequency.

Damped Harmonic Loading and Resonance

$$m \ddot{u}(t) + c \dot{u}(t) + k u(t) = p_0 \sin(\bar{\omega} t)$$

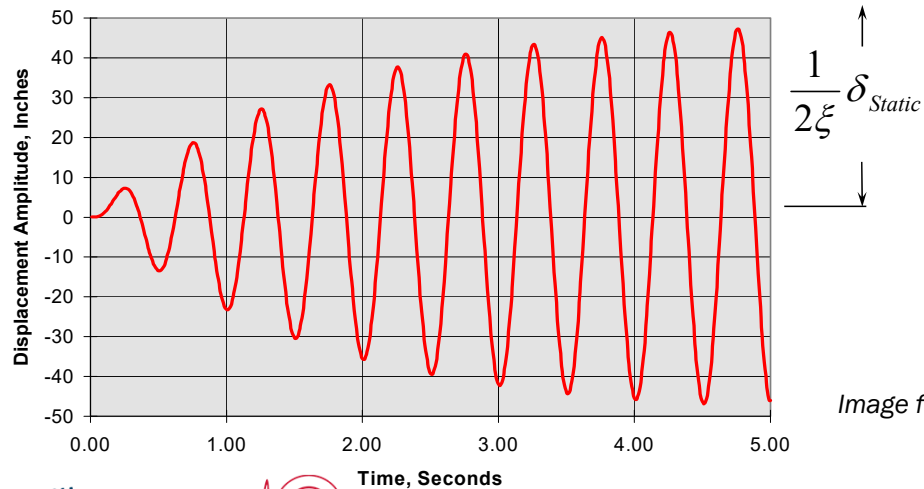

Image from Finley Charney



FEMA

Building Seismic
Safety Council



This slide contains an image showing damped harmonic loading and response.

When the damped system is loaded at resonance the response will initially build up rapidly, but it will eventually reach a steady state displacement as shown in the plot. The maximum displacement achieved (assuming no yielding) is $1/(2 \text{ times } \xi)$ times the static displacement (e.g. the displacement under p sub o applied as a static load).

Resonant Response Curve

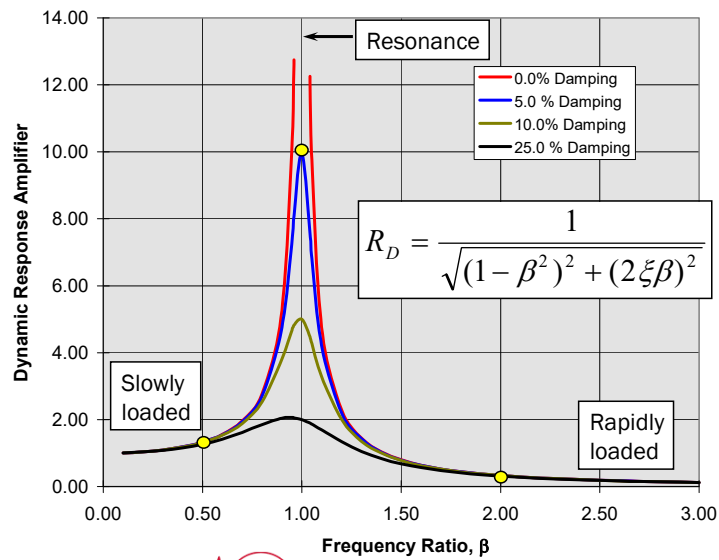

Image from Finley Charney



FEMA



Building Seismic Safety Council



This slide contains an image of a resonant response curve.

This plot is a set of resonance response curves, with one curve plotted for each of four damping values. The vertical axis (amplifier) is the ratio of maximum dynamic response to static response, and the horizontal axis is the ratio of loading frequency to structural frequency. As may be seen, when $\beta=1$ the system is in resonance, and damping is extremely effective in reducing response. Since earthquake loading is a resonant phenomena, damping is always very important, and the more the better.

General Dynamic Loading

- Fourier transform
- Duhamel integration
- Piecewise exact
- Newmark techniques

All techniques are carried out numerically.



FEMA



Building Seismic
Safety Council



This slide contains text showing the different ways in which it is possible to solve dynamic response.

For most types of dynamic loading there is not a closed-form solution. In such cases it is necessary to solve for the response using numerical procedures. This slide lists some of the more common methods. The last two methods are most commonly used. The piecewise exact method is restricted to linear systems, and it produces a mathematically exact response of the loading consists of linear load between discrete time increments. The Newmark method is close to exact for linear systems, and it may be used for nonlinear systems as well.

Effective Earthquake Force

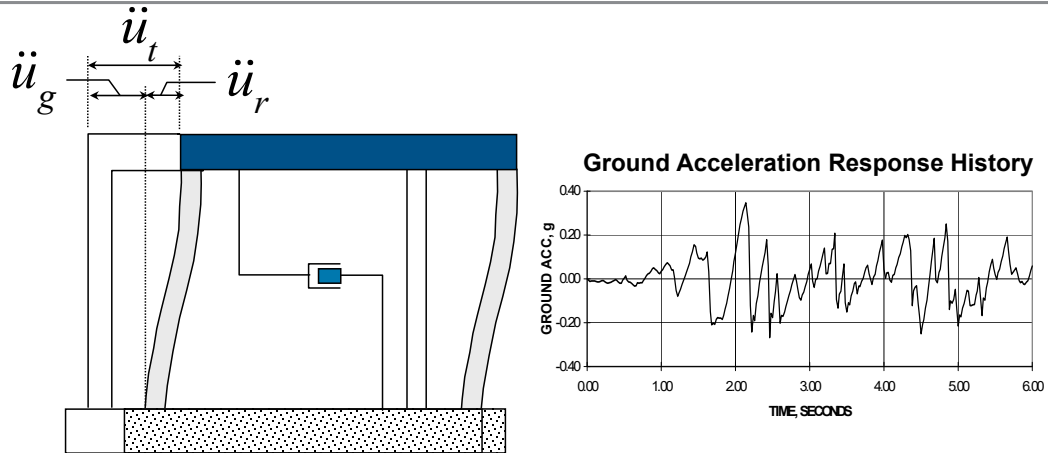

$$m[\ddot{u}_g(t) + \ddot{u}_r(t)] + c\dot{u}_r(t) + k u_r(t) = 0$$

$$m\ddot{u}_r(t) + c\dot{u}_r(t) + k u_r(t) = -m\ddot{u}_g(t)$$

Image from Finley Charney



FEMA

Building Seismic Safety Council



This slide contains two images, one of the simplified and idealized structure, the other of a ground acceleration response history. An equation underneath is of dynamic equilibrium.

Seismic load in the form of a ground acceleration history is converted to an equivalent seismic load as shown in this slide. Note that the response quantities (displacement, velocity, acceleration) are **relative to the base of the structure**, hence the subscript r. Given the digital nature of the loading, the piecewise linear method is most suitable for solution when the response is linear.

Simplified SDOF Equation of Motion

$$m\ddot{u}_r(t) + c\dot{u}_r(t) + ku_r(t) = -m\ddot{u}_g(t)$$

Divide through by m:

$$\ddot{u}_r(t) + \frac{c}{m}\dot{u}_r(t) + \frac{k}{m}u_r(t) = -\ddot{u}_g(t)$$

Make substitutions:

$$\frac{c}{m} = 2\xi\omega \qquad \frac{k}{m} = \omega^2$$

Simplified form:

$$\ddot{u}_r(t) + 2\xi\omega\dot{u}_r(t) + \omega^2u_r(t) = -\ddot{u}_g(t)$$



FEMA



Building Seismic
Safety Council



This slide contains equations of a simplified single degree of freedom system, or SDOF.

In this slide a revised equation of motion is shown where all terms have been divided through by mass (never zero). Now the response to a given ground motion can be computed “generically” for a system with a given damping ratio and frequency of vibration (actual mass and stiffness need not be specified). This form of the equation of motion is useful for computing response spectra.

Use of Simplified Equation of Motion

For a given ground motion, the response history $u_r(t)$ is function of the structure's frequency ω and damping ratio ξ .

$$\ddot{u}_r(t) + 2\xi\omega\dot{u}_r(t) + \omega^2 u_r(t) = -\ddot{u}_g(t)$$

Structural frequency

Damping ratio

Ground motion acceleration history



FEMA



Building Seismic
Safety Council



This slide clarifies different parts of the SDOF equation.

This slide repeats some of the points made on the previous slide, but in a more clear fashion.

Use of Simplified Equation

Change in ground motion or structural parameters ξ and ω requires re-calculation of structural response

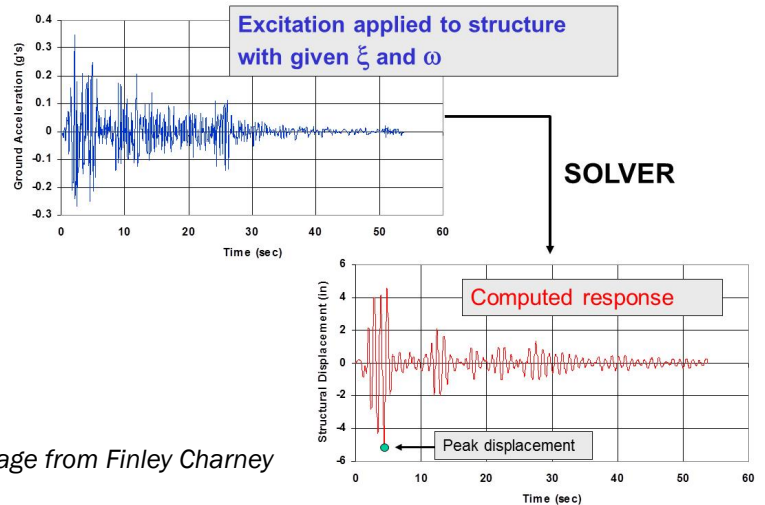

Image from Finley Charney



FEMA

Building Seismic Safety Council



This image illustrates the use of a “Solver”, such as the Piecewise Exact Method, to compute the response history. There are two graphs of the input and output of the solver.

This slide illustrates the use of a “Solver”, such as the Piecewise Exact Method, to compute the response history. For the purpose of computing response spectra, the key parameter of interest in the solution is the absolute value of maximum or “Peak” displacement, regardless of the sign or time of occurrence.

Creating an Elastic Response Spectrum

An *elastic displacement response spectrum* is a plot of the peak computed relative displacement, u_r , for an elastic structure with a constant damping ξ , a varying fundamental frequency ω (or period $T = 2\pi/\omega$), responding to a given ground motion.

5% damped response spectrum for structure responding to 1940 El Centro ground motion

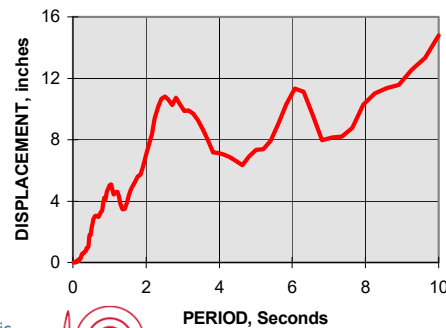

Image from Finley Charney



FEMA



Building Seismic Safety Council



The graph is a spectral displacement plot.

An elastic displacement response spectrum is computed by repeatedly solving a system with a given ground motion, given damping, and varying period of vibration. Note the jagged appearance of the curve, and mention that no two earthquakes will produce the same response spectrum. Note also that the displacement quantity being computed is the **relative displacement**.

Pseudoacceleration Spectrum

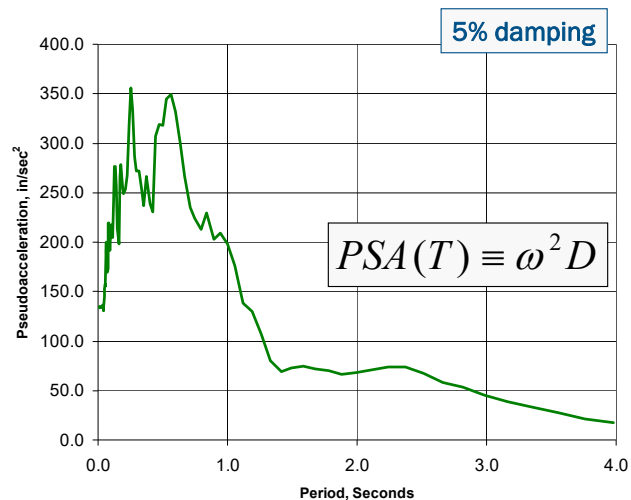

FEMA



Building Seismic
Safety Council



This slide contains a plot of a pseudoacceleration spectrum, and an equation showing how it is derived.

A very important curve, derived from the displacement spectrum, is the pseudoacceleration spectrum. It is obtained by dividing each displacement ordinate by the square of the circular frequency at given period. The mapped values of acceleration given by the *Provisions* are, essentially, pseudoacceleration ordinates at periods of 0.2 and 1.0 seconds.

Pseudoacceleration is Total Acceleration

The pseudoacceleration response spectrum represents the **total acceleration** of the system, not the relative acceleration. It is nearly identical to the true total acceleration response spectrum for lightly damped structures.

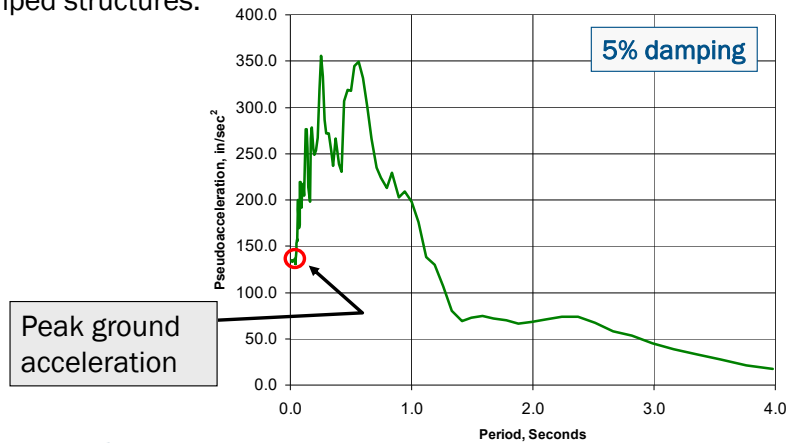

Image from Finley Charney



FEMA

Building Seismic Safety Council



This slide shows a plot of pseudoacceleration, and it highlights that pseudoacceleration is total acceleration.

It is very important to recognize that pseudoacceleration **is total acceleration**, even though it is derived from relative displacement. Thus, for $T=0$, pseudoacceleration is equal to the peak ground acceleration. At very large period (greater than about 10 seconds) pseudoacceleration will approach zero.

Using Pseudoacceleration to Compute Seismic Force

Example Structure

$$K = 500 \text{ k/in}$$

$$W = 2,000 \text{ k}$$

$$M = 2000/386.4 = 5.18 \text{ k-sec}^2/\text{in}$$

$$\omega = (K/M)^{0.5} = 9.82 \text{ rad/sec}$$

$$T = 2\pi/\omega = 0.64 \text{ sec}$$

5% critical damping

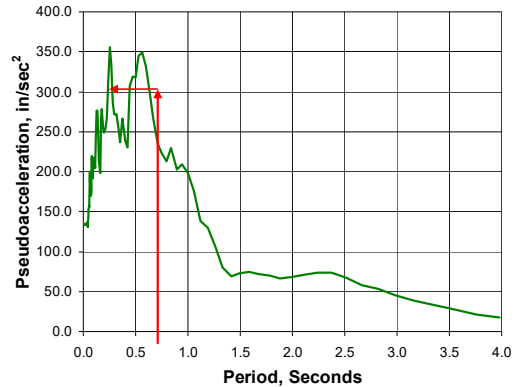

At $T = 0.64 \text{ sec}$, pseudoacceleration = 301 in./sec^2

Base shear = $M \times \text{PSA} = 5.18(301) = 1559 \text{ kips}$

Image from Finley Charney



FEMA

Building Seismic
Safety Council



This slide shows the same graph of pseudoacceleration and demonstrates how to use the graph to compute seismic force.

Given the pseudoacceleration spectrum, it is easy to compute the peak base shear developed in a SDOF system. Assuming 5% damping and the earthquake used to generate the spectrum (El Centro), the shear can be computed as shown. Once the shear is known the **relative displacement** can be found by dividing by k (thus the displacement spectrum is not needed)

Response Spectra for 1971 San Fernando Valley EQ (Holiday Inn)

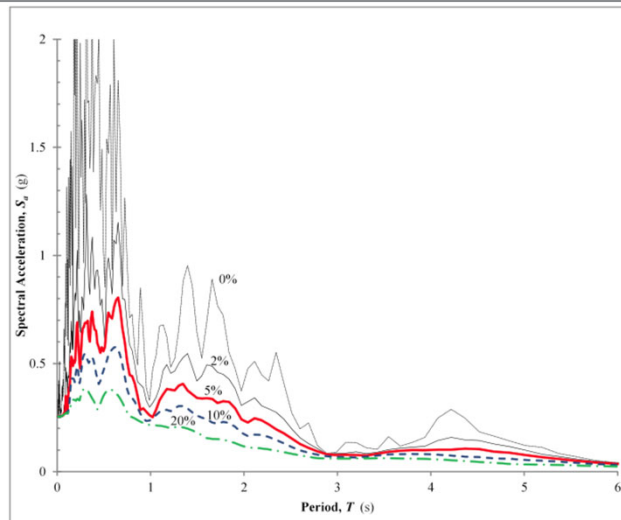

Image from Finley Charney



FEMA

Building Seismic
Safety Council



This slide contains a plot of spectral acceleration of different damping ratios for the 1971 San Fernando valley earthquake.

This slide shows several pseudoacceleration spectra for the 1971 San Fernando Valley, 1971 EQ. Here, the different spectra are for different damping values, ranging from zero to 20% critical. The bold red line is for 5% damping. Note the tremendous influence of damping on amplitude and shape, particularly at the lower periods.

Averaged Spectrum and Code Spectrum

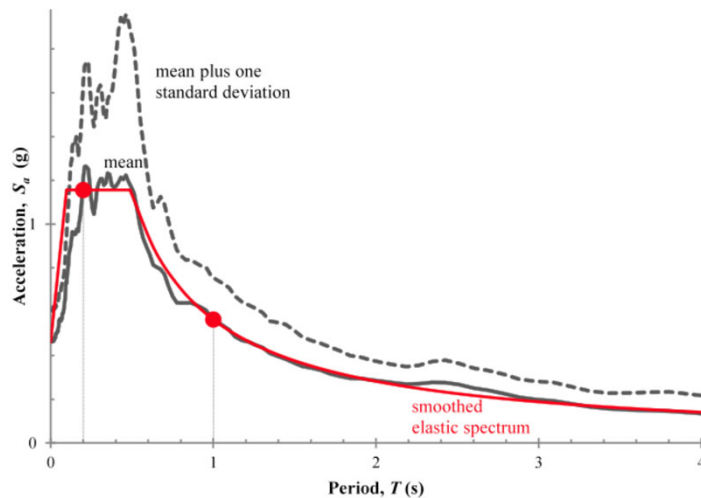

Image from Finley Charney



FEMA



Building Seismic
Safety Council



This slide contains a plot comparing the average spectrum compared to a smoothed code spectrum.

This chart shows the mean spectrum among seven ground motion spectra, the mean plus one standard deviation, and the “smoothed” code version of the spectrum (red line). Note the close fit between the average spectrum and the code spectrum (such fits are not always possible). The *Provisions*, as well as ASCE 7 use the smoothed spectrum in lieu of true ground motion spectra because of the ease of use and uniformity.

NEHRP/ASCE 7 Design Spectrum

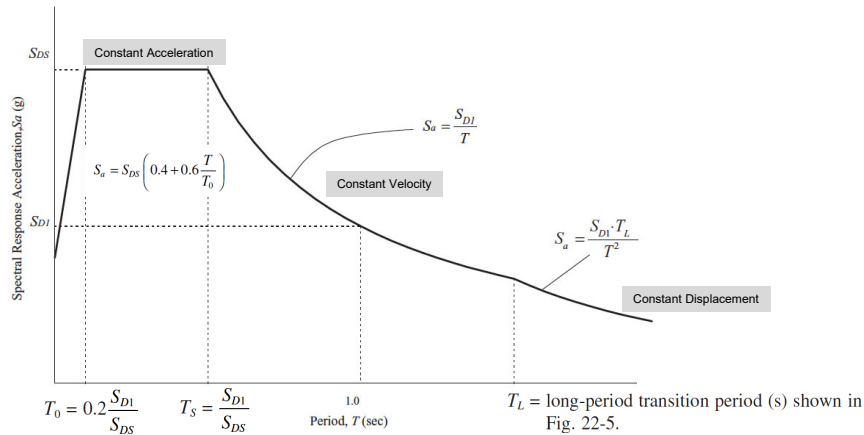

Image from Finley Charney



FEMA



Building Seismic Safety Council



This slide contains a graph of the NEHRP/ASCE7 basic design spectrum.

This slide shows the basic design spectrum, which is Figure 11.4-1 from ASCE 7-10. This spectrum would be used in Modal Response Spectrum Analysis as described in Section 12.9 of ASCE 7-10. The shape of this spectrum can be traced back to work done by Newmark in the 1960s. The Constant Velocity label indicates that if the spectrum were to be converted to a velocity spectrum, this segment of the spectrum would be constant. Similar for the Constant Displacement branch. Note the unit inconsistency of the values; for example, the division by T in the constant velocity region produces units inconsistency if the units of seconds are attached to T .

See the slide set on "Ground Motions" for more detail.

NEHRP 2020 Multi-Period Spectrum and "Two" Period Spectrum

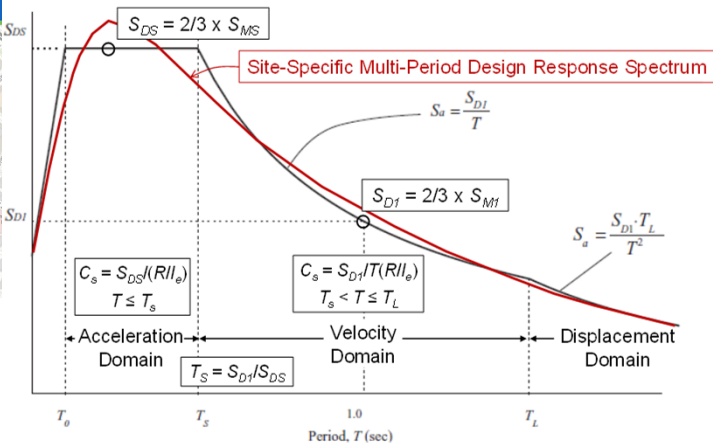
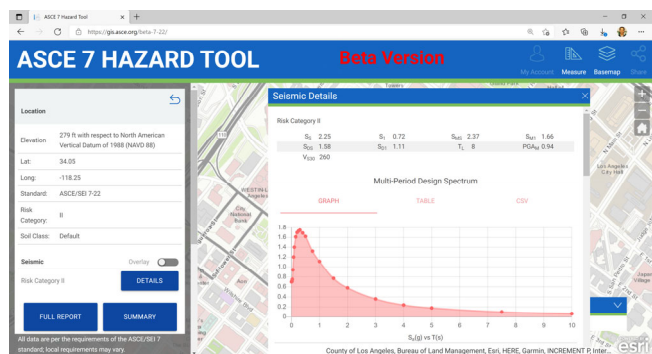

This slide shows the new multi-period spectrum (22 points) that is the basis of the 2020 *NEHRP Provisions* and ASCE 7-22, and how the conventional two period spectrum is derived from it. The S_{DS} value is 90% of the maximum S_a in short periods, and the S_{D1} value is set so the curve does not fall below 90% of the S_a in the velocity domain.

Overview

- Fundamental Concepts
- Ground Motions and Their Effects
- Structural Dynamics of Linear SDOF Systems
- Response Spectra
- **Structural Dynamics of Simple MDOF Systems**
- Inelastic Behavior
- Structural Design



FEMA



Building Seismic
Safety Council



This slide contains text that provides an overview of the topics presented in this slide set.

This slide provides an overview of the topics presented in this slide set.

MDOF Systems

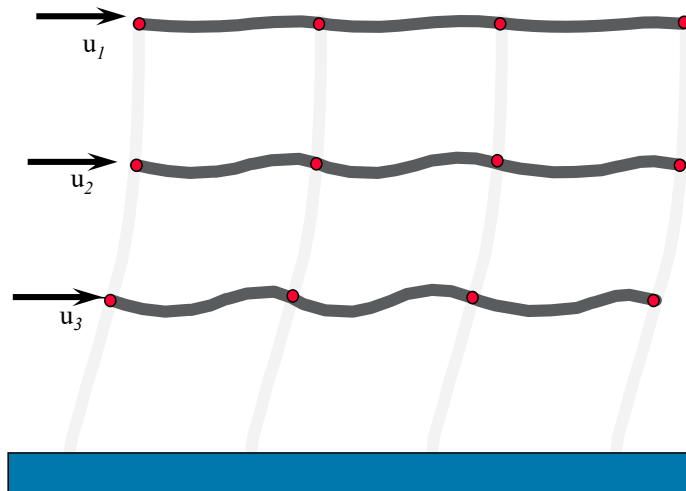

*Image from Finley
Charney*



FEMA



Building Seismic
Safety Council



This slide contains an image of a simplified multiple degree of freedom system, or MDOF

Analysis of Linear MDOF Systems

- MDOF Systems may either be solved step by step through time by using the full set of equations in the original coordinate system, or by transforming to the “Modal” coordinate system, analyzing all modes as SDOF systems, and then converting back to the original system. In such a case the solutions obtained are mathematically exact, and identical. This analysis is referred to as either Direct (no transformation) or Modal (with transformation) Linear Response History Analysis. This procedure is covered in Chapter 16 of ASCE 7.
- Alternately, the system may be transformed to modal coordinates, and only a subset (first several modes) of equations be solved step by step through time before transforming back to the original coordinates. Such a solution is approximate. This analysis is referred to as Modal Linear Response History Analysis. This procedure is not directly addressed in ASCE 7 (although in principle, Ch. 16 could be used)



FEMA



Building Seismic
Safety Council



This slide contains text explaining MDOFs, and how to solve them.

The points in this slide are self-explanatory.

Analysis of Linear MDOF Systems

- Another alternate is to convert to the modal coordinates, and instead of solving step-by-step, solve a subset (the first several modes) of SDOF systems system using a response spectrum. Such a solution is an approximation of an approximation. This analysis is referred to as Modal Response Spectrum Analysis. This procedure is described in Chapter 12 of ASCE 7.
- Finally, the equivalent lateral force method may be used, which in essence, is a one-mode (with higher mode correction) Modal Response Spectrum Analysis. This is an approximation of an approximation of an approximation (but is generally considered to be “good enough for design”.) The *Provisions* and ASCE 7 do place some restrictions on the use of this method.



FEMA



Building Seismic
Safety Council



This slide contains additional text explaining MDOFs, and how to solve them.

The points in this slide are self-explanatory.

Overview

- Fundamental Concepts
- Ground Motions and Their Effects
- Structural Dynamics of Linear SDOF Systems
- Response Spectra
- Structural Dynamics of Simple MDOF Systems
- **Inelastic Behavior**
- Structural Design



FEMA



Building Seismic
Safety Council



This slide contains text that provides an overview of the topics presented in this slide set.

This slide provides an overview of the topics presented in this slide set.

Basic Base Shear Equations in NEHRP and ASCE 7

$$V = C_s W$$
$$C_s = \frac{S_{DS}}{(R/I_e)} \qquad C_s = \frac{S_{D1}}{T(R/I_e)}$$

S_{DS} and S_{D1} are short and one second (T=0.2 s and 1.0 s) Design Basis Spectral Accelerations, including Site Effects

I_e is the Importance Factor

R is a Response Modification Factor, representing Inelastic Behavior (Ductility, Over-strength, and a few other minor ingredients).



FEMA



Building Seismic
Safety Council



This slide contains equations covering how to compute base shear based on the *NEHRP Provisions* and ASCE 7

These formulas from Chapter 12 of ASCE 7 have the value R in the denominator. The next several slides provide the background on R .

Building Designed for Wind or Seismic Load

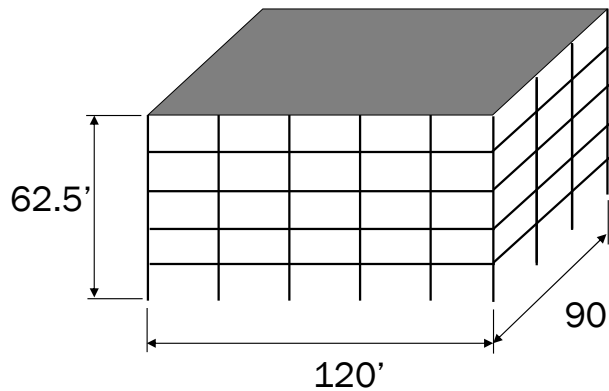

Building properties:
Moment resisting frames
Density $\rho = 8$ pcf
Period $T = 1.0$ sec
Damping $\xi = 5\%$
Soil Site Class "B"

Image from Finley Charney

Total wind force on 120' face = **406 kips**

Total wind force on 90' face = **304 kips**

Total **ELASTIC** earthquake force (in each direction) = **2,592 kips**



FEMA



Building Seismic
Safety Council



This slide contains an image of a simplified structure and its properties, and design wind and seismic loads.

This slide shows (without detailed computations) the total factored wind forces acting on a building at some location, and the ELASTIC seismic forces for the same location. This could represent, for example, a building near Charleston, S.C.

Comparison of EQ vs Wind

- ELASTIC earthquake forces 6 to 9 times wind!
- Virtually impossible to obtain economical design

$$\frac{V_{EQ}}{V_{W120}} = \frac{2592}{406} = 6.4$$

$$\frac{V_{EQ}}{V_{W90}} = \frac{2592}{304} = 8.5$$



FEMA



Building Seismic
Safety Council



This slide compares the difference between design elastic seismic forces and design wind loads.

The computation shows that the seismic loads are 6.4 to 8.5 times the wind forces. When designing for wind it is assumed that the structure remains elastic up to the factored wind loads. It would seem economically prohibitive to design the building to remain elastic for the earthquake loads.

How to Deal with Huge EQ Force?

- Pay the premium for remaining elastic
- Isolate structure from ground (seismic isolation)
- Increase damping (passive energy dissipation)
- **Allow controlled inelastic response**

Historically, building codes use **inelastic response procedure**.

Inelastic response occurs through structural **damage** (yielding).

We must control the damage for the method to be successful.



FEMA



Building Seismic
Safety Council



This slide contains text discussing different means to design for large earthquake forces.

There are a variety of strategies for dealing with the large earthquake forces. The first choice should be avoided except in very special circumstances, such as the design of nuclear power plants. The second two approaches are viable (and supported by the *Provisions* and ASCE 7 with separate chapters) but are not commonly used due to extra cost and required expertise. The vast majority of buildings are designed using the inelastic response method. This is true even in the highest seismic risk areas.

Nonlinear Static Pushover Analysis

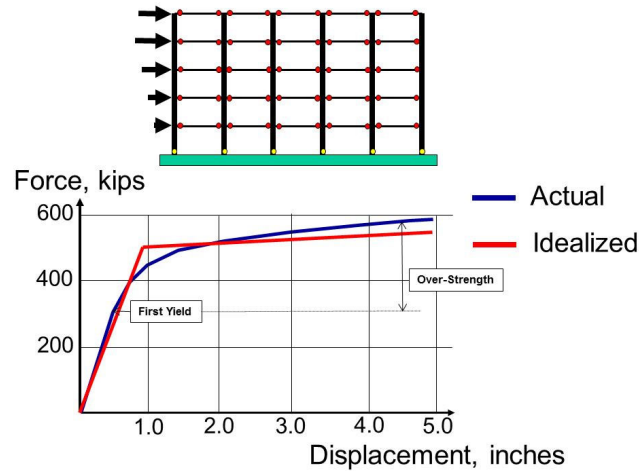

Image from Finley Charney



FEMA

Building Seismic Safety Council



This slide contains an image demonstrating a nonlinear static pushover on a frame, and below shows a plot of its resulting force displacement relationship.

In this slide, we will assume the building with a 2,592 k earthquake load is designed for a strength of about 500 kips, well less than the seismic demand. Assuming the structure has sufficient ductility, it is mathematically “Pushed Over” to form the solid blue line force-displacement shown. Note that the building has considerable reserve strength (called over-strength) beyond first yield. We will make a rather large simplification and assume that the entire building can then be represented dynamically as a SDOF system with the bilinear force-deformation curve shown in red, perform a nonlinear response history analysis to assess the expected behavior. Note that ductility is the ability to deform beyond first yield without excessive loss of strength.

Note that actual ductility above 10 (as shown in the slide) is not realistic for real buildings, and even when $R=8$ a significant portion of that value is related to entities other than ductility (as explained later in this set).

Mathematical Model and Ground Motion

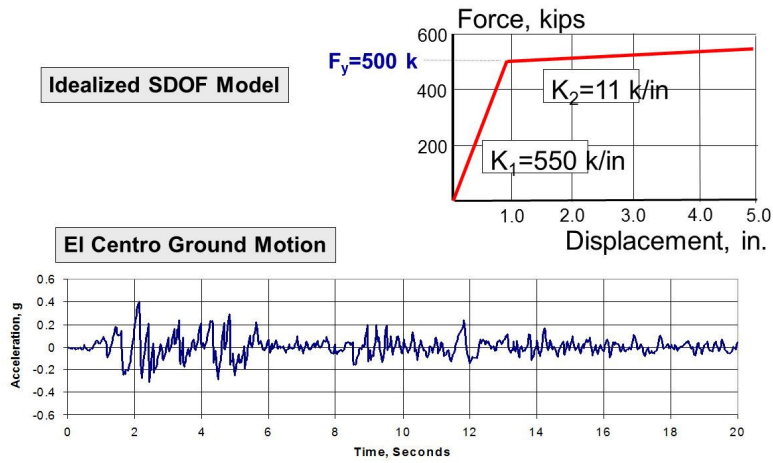

Image from Finley Charney



FEMA

Building Seismic Safety Council



This slide shows the simplified mathematical model and the ground motion used for response history analysis.

Results of Nonlinear Analysis

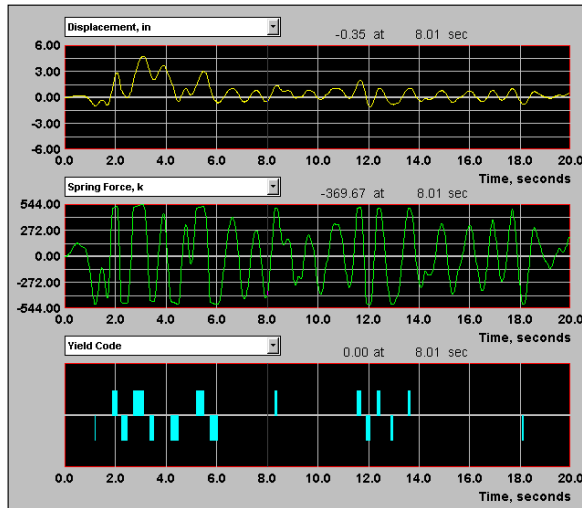

Maximum displacement:

4.79"

Maximum shear force:

542 k

Number of yield events:

15

Image from Finley Charney



FEMA



Building Seismic Safety Council



This slide shows plots of the displacement, spring force, and number yield events of a nonlinear analysis.

The analysis results, produced by the NONLIN Program, is show on this slide. The maximum displacement achieved is 4.79 inches and the maximum shear is 542 kips. There are 15 yield events, seven in one direction and eight in the other.

Response Computed by Nonlin

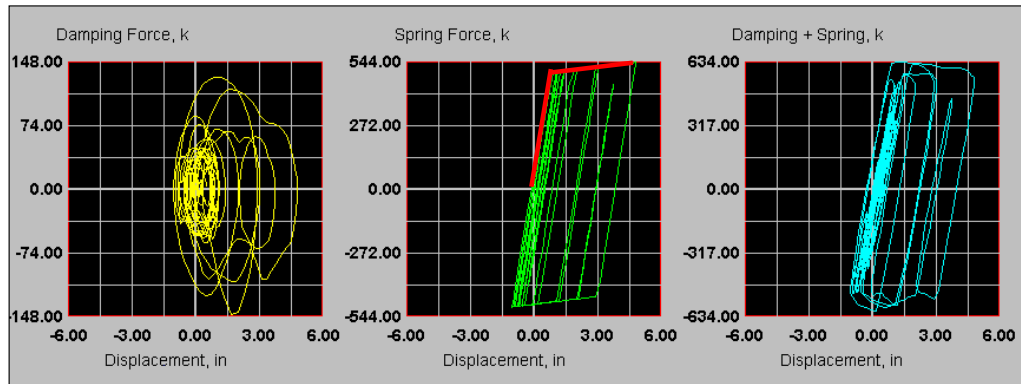

Yield displacement = $500/550 = 0.91$ inch

$$\text{Ductility Demand} \equiv \frac{\text{Maximum Displacement}}{\text{Yield Displacement}} = \frac{4.79}{0.91} = 5.26$$



FEMA

Building Seismic Safety Council



Image from Finley Charney

62

This image demonstrates the concept of ductility demand in graphical form. The first panel is member force only, the second panel is member shear only, and the third panel is member shear plus damping, or total base shear.

This slide gives the basic definition for ductility *demand*. If this much ductility is not actually *supplied* by the structure, collapse may occur.

Note the difference in the second and third force-displacement panels of the slide. The second panel is member shear only and the third panel is member shear plus damping, or total base shear.

Write basic design equation:

$$\text{Ductility Demand} < \text{Ductility Supply}$$

Interim Conclusion (the Good News)

The frame, designed for a wind force which is 15% of the ELASTIC earthquake force, can survive the earthquake if:

- It has the capability to undergo *numerous cycles of INELASTIC deformation*
- It has the capability to *deform at least 5 to 6 times the yield deformation*
- It suffers *no appreciable loss of strength*

REQUIRES ADEQUATE DETAILING



FEMA



Building Seismic
Safety Council



This slide has text going over conclusions of the analysis.

This slide is the “Good News.” It appears that the building can survive the earthquake, but ONLY if the above conditions are met.

Interim Conclusion (The Bad News)

As a result of the large displacements associated with the inelastic deformations, the structure will suffer considerable structural and nonstructural damage.

- This damage must be controlled by adequate detailing and by limiting structural deformations (drift).



FEMA



Building Seismic
Safety Council



This slide has text going over conclusions of the analysis.

The bad news is that the building will probably suffer considerable damage to the structural and nonstructural system. It may be repairable after the earthquake, but there is no guarantee. Also, the *Provisions* and ASCE 7 are based on the recognition that there is a small (about 1% in 50 years) but real probability of collapse. Neither the *NEHRP Provisions* or ASCE 7 provides any explicit protection from damage during moderate earthquakes, and thus they are both considered as “Life Safety” provisions. New concepts in earthquake engineering, called Performance Based Design are being developed to alleviate this issue, but it will be several years before these concepts are brought into the code.

Development of the Equal Displacement Concept

Concept used by:

IBC } In association with “force based”
NEHRP } design concept. Used to predict
ASCE-7 } design forces and displacements

ASCE 41 } In association with static pushover
analysis. Used to predict displacements
at various performance points.



FEMA



Building Seismic
Safety Council



This slide contains text that goes over the development of the equal displacement concept.

The equal displacement concept is the basis for dividing the “Elastic” force demands by the factor R . This is one of the most important concepts in earthquake engineering. The basis for the equal displacement concept is illustrated in the following slides.

The Equal Displacement Concept

“The displacement of an inelastic system, with stiffness K and strength F_y , subjected to a particular ground motion, is approximately equal to the displacement of the same system responding elastically.”

(The displacement of a system is independent of the yield strength of the system.)



FEMA



Building Seismic
Safety Council



This slide contains text explaining the equal displacement concept.

The Equal Displacement Concept in words.

Repeated Analysis for Various Yield Strengths (and constant stiffness)

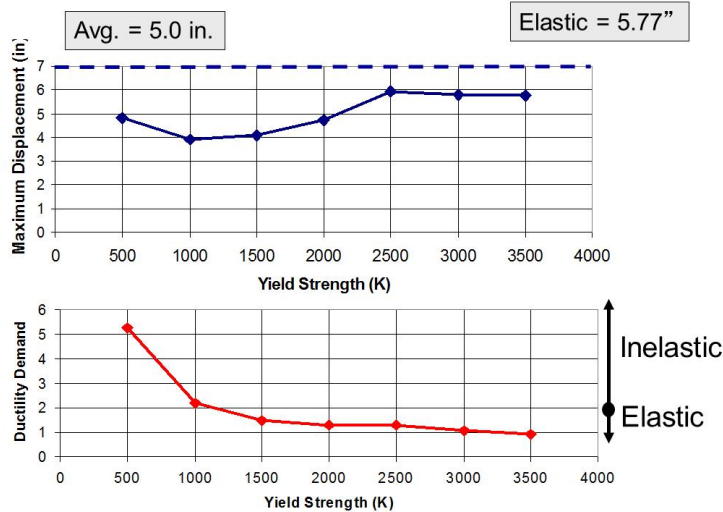

Image from Finley Charney



FEMA

Building Seismic Safety Council



This slide contains plots from NONLIN analyses showing the effects of yield strength on response.

This slide is based on a series of NONLIN analyses wherein all parameters were kept the same as in the original model except for the yield strength, which was systematically increased in 500 kip increments to a maximum of 3,500 kips. The structure with a 3,500 kip strength remains elastic during the earthquake. Note that the displacement appears to be somewhat independent of yield strength, but the ductility demand is much higher for relatively lower strengths.

Constant Displacement Idealization of Inelastic Response

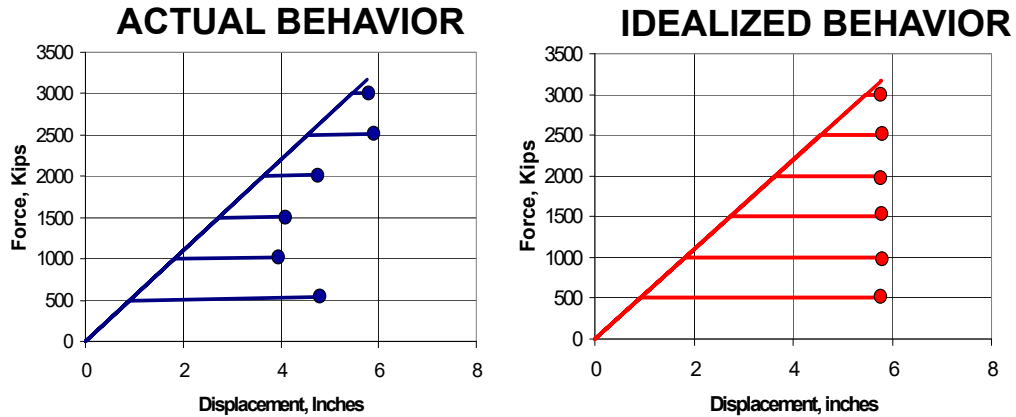

Image from Finley Charney



FEMA



Building Seismic
Safety Council



This slide contains two plots highlighting the difference between actual and idealized inelastic response of equal displacement.

This slide shows simplified force-displacement envelopes from the different analyses. An apparently conservative assumption (with regard to displacements) is shown on the right. The basic assumption is that the displacement demand is relatively insensitive to system yield strength. This is often referred to as the “equal displacement” concept of seismic-resistant design.

Equal Displacement Idealization of Inelastic Response

- For design purposes, it may be assumed that inelastic displacements are equal to the displacements that would occur during an elastic response.
- The required force levels under inelastic response are much less than the force levels required for elastic response.



FEMA



Building Seismic
Safety Council



This slide contains text summarizing last slide.

Equal Displacement Concept of Inelastic Design

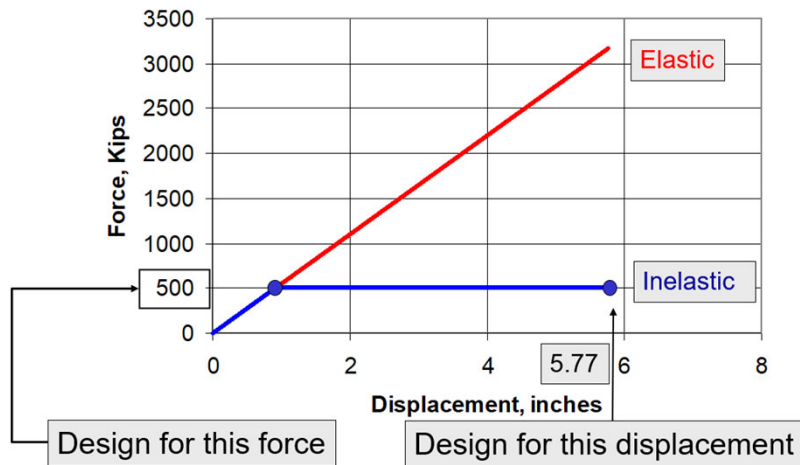

Image from Finley Charney



FEMA

Building Seismic Safety Council



This slide contains a plot showing the concept of equal displacement in a force displacement plot.

The equal displacement concept allows us to use elastic analysis to predict inelastic displacements. For the example system, the predicted elastic displacement (red line) is 5.77 inches, and it is assumed that the inelastic response (blue line) displacement is the same.

Key Ingredient: Ductility

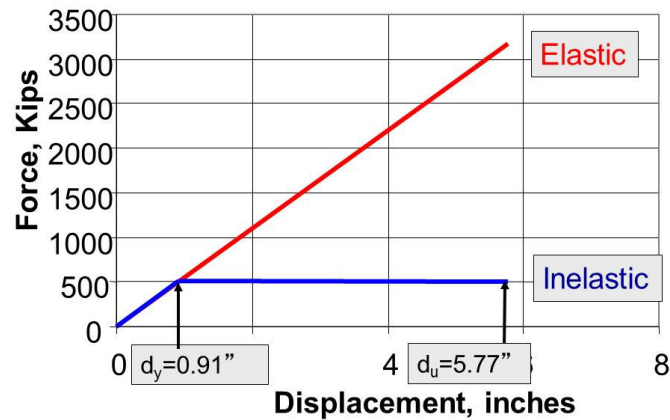

Image from Finley Charney

$$\text{Ductility supply MUST BE} > \text{ductility demand} = \frac{5.77}{0.91} = 6.34$$



FEMA

Building Seismic Safety Council



This slide contains the same plot as last slide, but it highlights the ductility demand of the inelastic system.

For this simple bilinear system, the ductility demand can now be computed. The system must be detailed to have this level of ductility.

For design purposes, we typically reverse the process. We assume some ductility supply (based on the level of detailing provided) and, using this, we can estimate the strength requirements.

Application in Principle

Using response spectra, estimate **elastic** force demand F_E

Estimate ductility supply, m , and determine **inelastic** force demand $F_I = F_E/m$. **Design structure for F_I .**

Compute reduced displacement, d_R , and multiply by m to obtain true inelastic displacement, d_I . **Check Drift using d_I .**

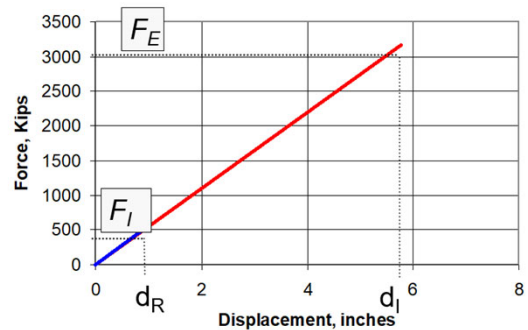

Image from Finley Charney



FEMA

Building Seismic Safety Council



This slide highlights the procedure to apply inelastic force demand in practice. There is an image of a force displacement plot, and it highlights the elastic and inelastic forces one would design for.

The procedure mentioned in the previous slide is explained in more detail here.

Building codes allow for an elastic structural analysis based on applied forces reduced to account for the presumed ductility supplied by the structure. For elastic analysis, use of the reduced forces will result in a significant underestimate of displacement demands. Therefore, the displacements from the reduced-force elastic analysis must be multiplied by the ductility factor to produce the true “inelastic” displacements.

Application in Practice (NEHRP and ASCE 7)

Use basic elastic spectrum but, for strength, divide all pseudoacceleration values by R , a response modification factor that accounts for:

- Anticipated ductility supply
- Overstrength
- Damping (if different than 5% of critical)
- Past performance of similar systems
- Redundancy



FEMA



Building Seismic
Safety Council



This slide contains text explain the response modification factor R , and its implications.

The approach to using the equal displacement concept is discussed in the next several slides. One of the key aspects of the method is the use of the response modification factor, R . This term includes a variety of “ingredients,” the most important of which are ductility and overstrength.

Note that overstrength did not enter into the previous discussion because we were working with idealized systems. Real structures are usually much stronger than required by design. This extra strength, when recognized, can be used to reduce the ductility demands. (If the overstrength was so large that the response was elastic, the ductility demand would be less than 1.0.)

Ductility/Overstrength First Significant Yield

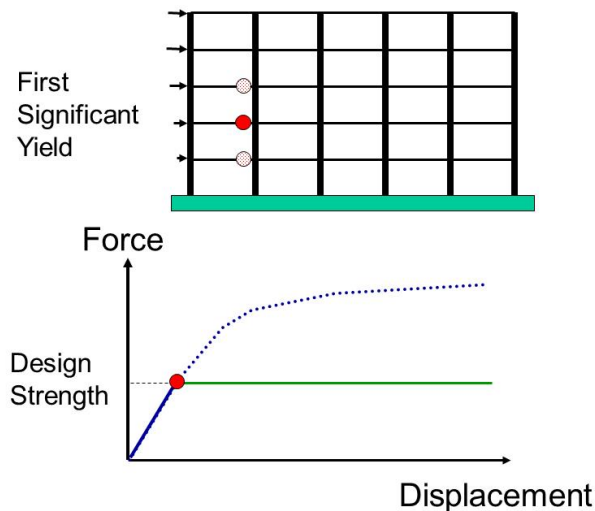

Image from Finley Charney



FEMA



Building Seismic
Safety Council



This slide contains an image of a simplified frame undergoing a pushover analysis. Underneath shows a force displacement plot, highlighting first significant yield.

In this slide and several that follow as structure is being subjected to a pushover analysis. The structure remains essentially elastic until the first full plastic hinge forms. The formation of this “first significant yield” occurs at a level of load referred to as the design strength of the system.

If the hinging region has adequate ductility, it can sustain increased plastic rotations without loss of strength. At the same time, the other potential hinging regions of the structure will attract additional moment until they begin to yield.

First Significant Yield and Design Strength

First Significant Yield is the level of force that causes complete plastification of at least the most critical region of the structure (e.g., formation of the first plastic hinge).

The design strength of a structure is equal to the resistance at first significant yield.



FEMA



Building Seismic
Safety Council



This slide contains text explaining first significant yield.

These definitions come from the commentary to the *NEHRP Provisions* and the commentary to ASCE 7.

Overstrength

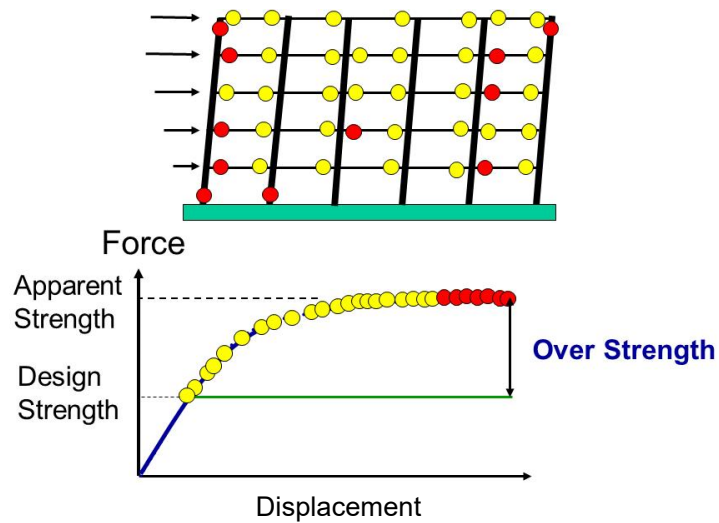

Image from Finley Charney



FEMA



Building Seismic
Safety Council



This slide shows the same simplified frame undergoing pushover and the sequential formation of plastic hinges. Underneath, the force displacement curve also shows the plastic hinges.

This slide show the sequential formation of plastic hinges in the structure. With sufficient ductility, the apparent strength can be considerably greater than the design strength. The reserve capacity is called Overstrength.

Sources of Overstrength

- Sequential yielding of critical regions
- Material overstrength (actual vs specified yield)
- Strain hardening
- Capacity reduction (ϕ) factors
- Member selection
- Structures where the proportioning is controlled by the seismic drift limits



FEMA



Building Seismic
Safety Council



This slide contains text listing the sources of overstrength.

This slide lists most of the sources of overstrength. It is not uncommon for the true strength of a structure, including overstrength, to be two to three times the design strength.

Definition of Overstrength Factor Ω

$$\text{Overstrength Factor } \Omega = \frac{\text{Apparent Strength}}{\text{Design Strength}}$$

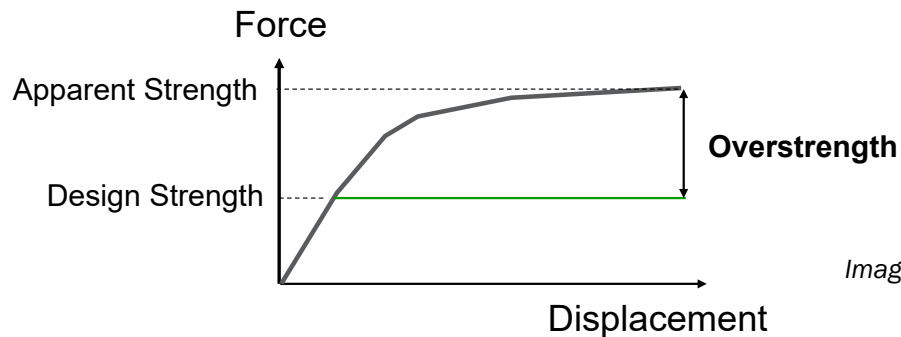

Image from Finley Charney



FEMA



Building Seismic
Safety Council



The image is a force displacement plot showing the definition of overstrength.

This slide defines overstrength in both an equation, and in graphical format in a force displacement plot.

The apparent strength divided by the design strength is called the “overstrength factor.” Note that the symbol Ω used for the overstrength factor is similar to the term Ω_0 in ASCE 7.

As implemented in ASCE 7, Ω_0 is intended to be a high estimate of true overstrength (although not an upper bound).

Definition of Ductility Reduction Factor R_d

$$\text{Ductility Reduction } R_d = \frac{\text{Elastic Strength Demand}}{\text{Apparent Strength}}$$

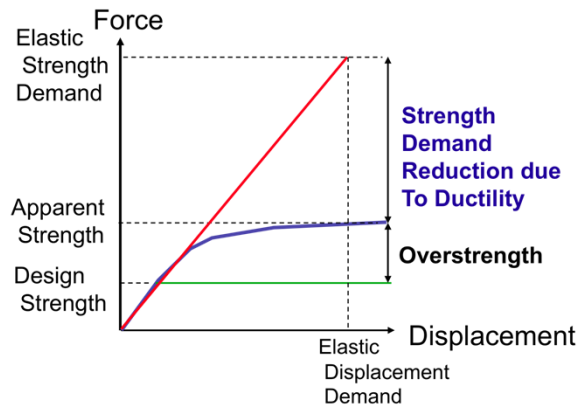

Image from Finley Charney



FEMA



Building Seismic
Safety Council



The image is a force displacement plot showing the definition of ductility reduction factor R_d .

This slide defines ductility reduction factor R_d in both equation and in graphical format in a force displacement plot.

This is the definition of that part of R due to ductility.

Definition of Response Modification Coefficient R

$$\text{Overstrength Factor } \Omega = \frac{\text{Apparent Strength}}{\text{Design Strength}}$$

$$\text{Ductility Reduction } R_d = \frac{\text{Elastic Strength Demand}}{\text{Apparent Strength}}$$

$$R = \frac{\text{Elastic Strength Demand}}{\text{Design Strength}} = R_d \Omega$$



FEMA



Building Seismic
Safety Council



This slide contains equations of overstrength and ductility in equation format, and R which is the product of overstrength and ductility reduction.

The NEHRP/ASCE 7 response modification factor, R , is equal to the ductility reduction factor times the overstrength factor.

Caution the student that the required R_d is not equal to R divided by the tabulated Ω_0 , because the tabulated values are definitely not lower bound values.

Definition of Response Modification Coefficient R

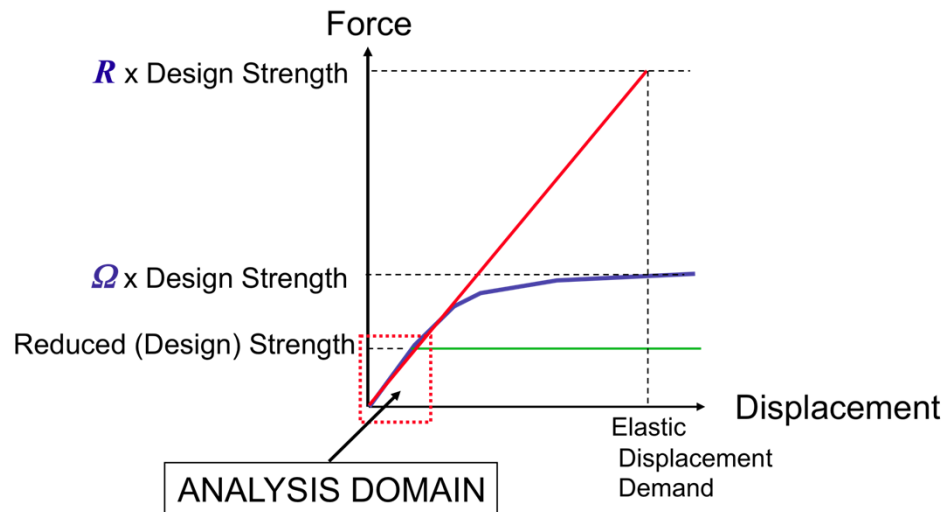

FEMA



Building Seismic
Safety Council



Image from Finley Charney

81

This figure is a graphical version of the information presented in the previous slide. The response modification factor, R , is used to reduce the expected elastic strength demand to the DESIGN level strength demand.

This slide defines the response modification coefficient, R , in graphical format in a force displacement plot.

On the basis of the equal displacement theory the inelastic displacement demand is the same as the elastic displacement demand. For design purposes, however, the reduced design strength is applied to the structure to determine the member forces. The analysis domain represents the response of the linear elastic system as analyzed with the reduced forces. Clearly the displacement predicted by this analysis is too low. The *Provisions* (ASCE 7) compensates through the use of the C_d factor.

Definition of Deflection Amplification Factor C_d

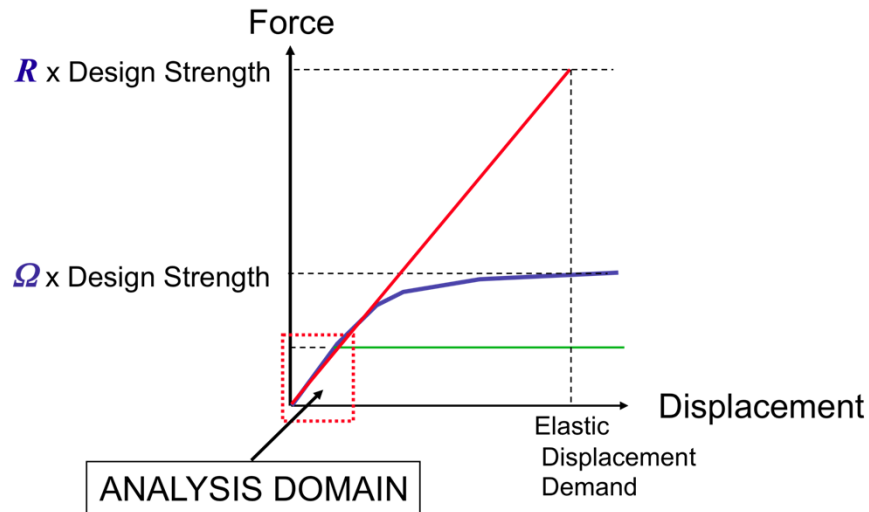

FEMA

Building Seismic Safety Council



Image from Finley Charney

82

This slide defines the deflection amplification factor, C_d , in graphical format in a force displacement plot.

To correct for the too-low displacement predicted by the reduced force elastic analysis, the “computed design displacement” is multiplied by the factor C_d . This factor is always less than the R factor because R contains ingredients other than pure ductility. In theory the primary factor reducing displacement demand is damping that is higher than the standard 5% damping used to develop the design spectra in the *Provisions*, but some of the C_d factors are not consistent with this explanation. Overstrength does not contribute to reduction of displacement demand.

Example of Design Factors for Reinforced Concrete Structures

	R	Ω_o	C_d
Special Moment Frame	8	3	5.5
Intermediate Moment Frame	5	3	4.5
Ordinary Moment Frame	3	3	2.5
Special Reinforced Shear Wall	5	2.5	5.0
Ordinary Reinforced Shear Wall	4	2.5	4.0
Detailed Plain Concrete Wall	2	2.5	2.0
Ordinary Plain Concrete Wall	1.5	2.5	1.5



FEMA



Building Seismic
Safety Council



This slide contains example design factors for typical structure types.

These are the design coefficients for a few selected concrete systems. Note the very low R values for the plain walls. These plain wall systems are allowed only in SDC A and B buildings. ACI 318 only permits plain concrete where it is continuously supported.

Note that the values Ω_o are not exactly the same as the overstrength factor Ω , and might be considered as reasonable upper bounds on Ω . They are used in certain load combinations that require extra capacity in key elements and components of a structure.

Design Spectra as Adjusted for Inelastic Behavior

$$C_S = \frac{S_{DS}}{R/I}$$

$$C_S = \frac{S_{D1}}{T(R/I)}$$

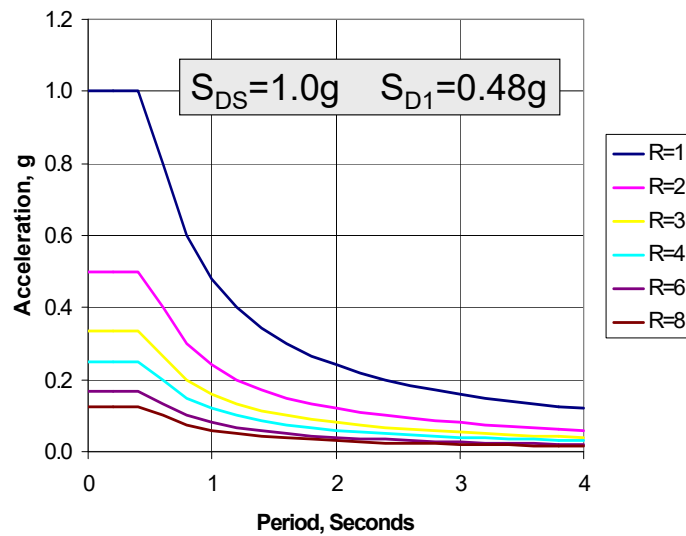

FEMA



Building Seismic
Safety Council



Image from Finley Charney

84

This slide contains a graph of design spectra adjusted for inelastic behavior.

In the previous slides, the concept of the reduction factor, R , was presented, and several values were illustrated. Here, the effect of the R value of the design response spectrum is illustrated for $R = 1$ (elastic) through 6. The value for $R = 1$ has been normalized to produce a peak short period acceleration of 1.0g.

Using Inelastic Spectrum to Determine Inelastic Force Demand

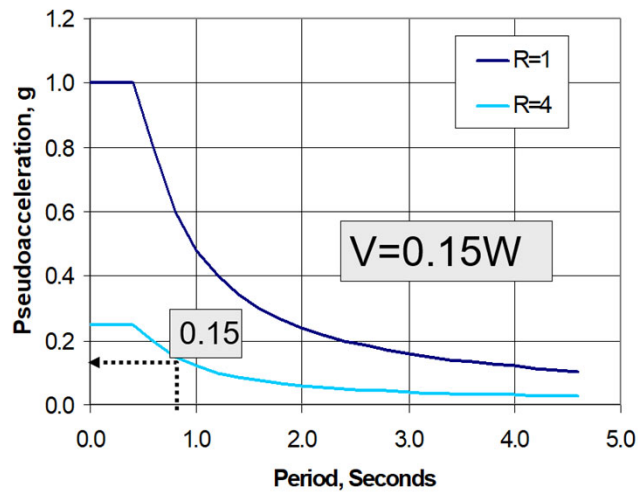

Image from Finley Charney



FEMA



Building Seismic
Safety Council



This slide contains a graph of pseudoacceleration spectra with different R factors.

This slide simply shows how the design base shear is determined for a system with $T = 0.8$ seconds and $R = 4$. The pseudoacceleration spectrum is used.

Using the Inelastic Spectrum and C_d to Determine the Inelastic Displacement Demand

$$\Delta_{INELASTIC} = C_d \times \Delta_{REDUCED ELASTIC}$$

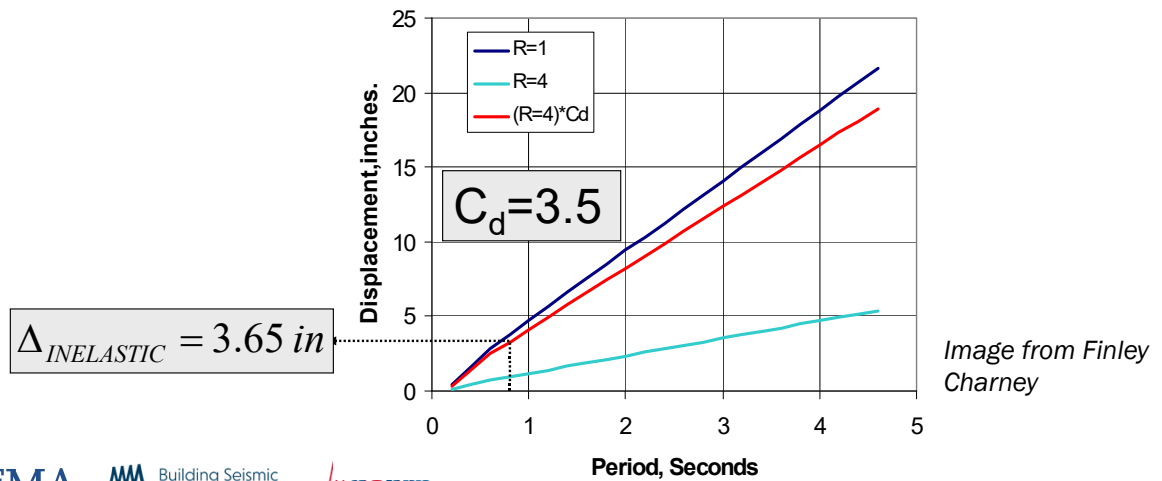

FEMA

Building Seismic Safety Council



This slide conveys how to compute the inelastic displacement demand through the use of C_d and the inelastic displacement spectrum.

At the period of 0.8 the displacement is read off the red line, which includes C_d . In practice, one would not generally use a displacement spectrum. Instead, the displacements would be determined from the elastic model with the reduced ($1/R$) loads, and these would be multiplied by C_d .

Overview

- Fundamental Concepts
- Ground Motions and Their Effects
- Structural Dynamics of Linear SDOF Systems
- Response Spectra
- Structural Dynamics of Simple MDOF Systems
- Inelastic Behavior
- **Structural Design**



FEMA



Building Seismic
Safety Council



This slide contains text that provides an overview of the topics presented in this slide set.

This slide provides an overview of the topics presented in this slide set.

Design and Detailing Requirements

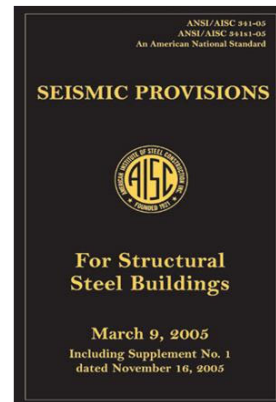
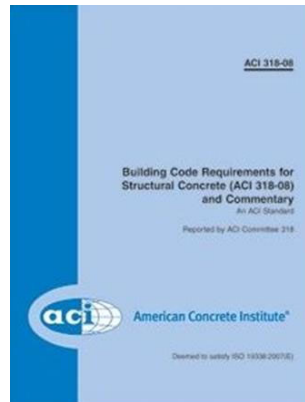

FEMA



Building Seismic
Safety Council



This slide contains images of the cover of ACI and AISC.

While the *Provisions* and ASCE 7 provide the basic configuration and loading requirements, the Detailing that is necessary to support a given R value is provided in materials standards such as ACI 318 and AISC 341. In some cases, the International Building Code or local jurisdictions will have additional requirements.

Questions



FEMA

Building Seismic
Safety Council



DISCLAIMER

- NOTICE: Any opinions, findings, conclusions, or recommendations expressed in this publication do not necessarily reflect the views of the Federal Emergency Management Agency. Additionally, neither FEMA, nor any of its employees make any warranty, expressed or implied, nor assume any legal liability or responsibility for the accuracy, completeness, or usefulness of any information, product or process included in this publication.
- The opinions expressed herein regarding the requirements of the *NEHRP Recommended Seismic Provisions*, the referenced standards, and the building codes are not to be used for design purposes. Rather the user should consult the jurisdiction's building official who has the authority to render interpretation of the code.
- This training material presentation is intended to remain complete in its entirety even if used by other presenters. While the training material could be tailored for use in other presentations, we caution users to account for issues of completeness and interpretation if only part of the material is used. We also strongly suggest users give proper credit/citation to this presentation and its author.



FEMA



Building Seismic
Safety Council



Chapter 2 (Section 2.7) Resilience-Based Design

2020 NEHRP Provisions Training Materials

David Bonowitz, S.E.



FEMA



Building Seismic
Safety Council

BSSC



Content

- Development of resilience-based earthquake design
 - 2020 NEHRP Provisions, Resource Paper 1
- Functional Recovery (FR)
 - Its relation to resilience
 - Its relation to current building code provisions
- Hypothetical application to the CLT Design Example
 - CLT Shear Wall Design Example is in Chapter 6
 - Discussion in terms of resilience-based design is in Section 2.7



NEHRP Recommended Seismic Provisions for New Buildings and Other Structures

Volume II: Part 3 Resource Papers
FEMA P-2082-2/ September 2020



FEMA

Building Seismic
Safety Council



Consensus

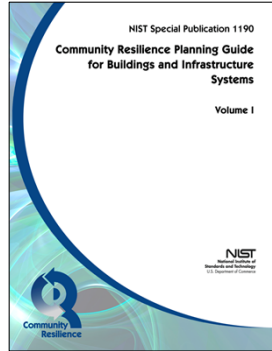

NIST, 2016

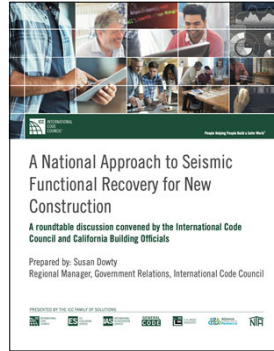

ICC, 2019



EERI, 2019

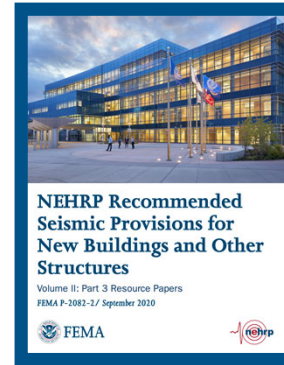

FEMA, 2020

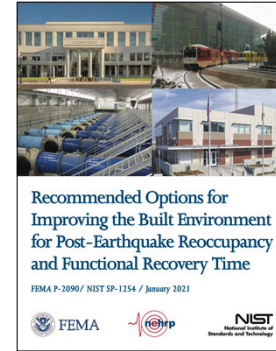

FEMA-NIST, 2021

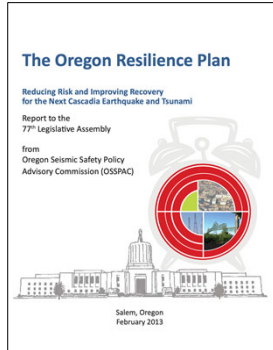

Oregon, 2013

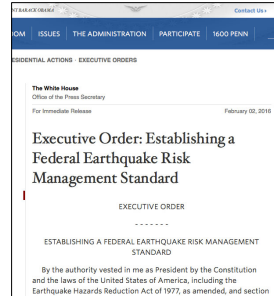

White House, 2016

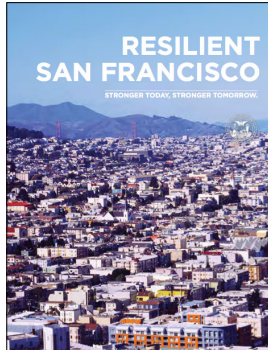

San Francisco, 2016

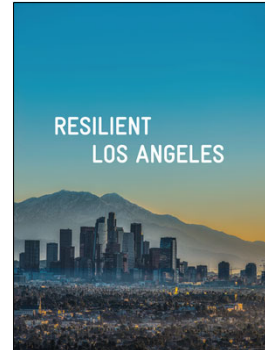

Los Angeles, 2018

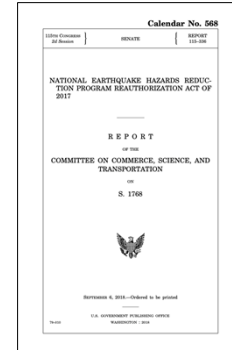

Public Law, 2018

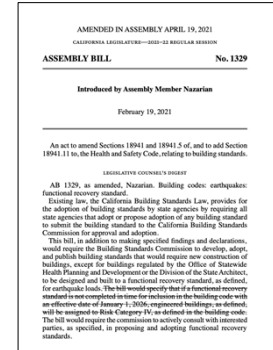

California, 2021



FEMA



Building Seismic Safety Council



Consensus understanding of *resilience*

- An attribute of organizations or social units, not buildings
 - Congress' 2018 NEHRP Reauthorization focuses on resilience at the *community* scale
- Emphasis on recovery, not just safety
- Measured in terms of time, not immediate damage
- Relative to a natural hazard event

Q: If resilience is not about individual buildings, what does it mean to design individual buildings for resilience?

A: Design to achieve a “functional recovery objective.”



FEMA



Building Seismic
Safety Council



The “Resilience Field”

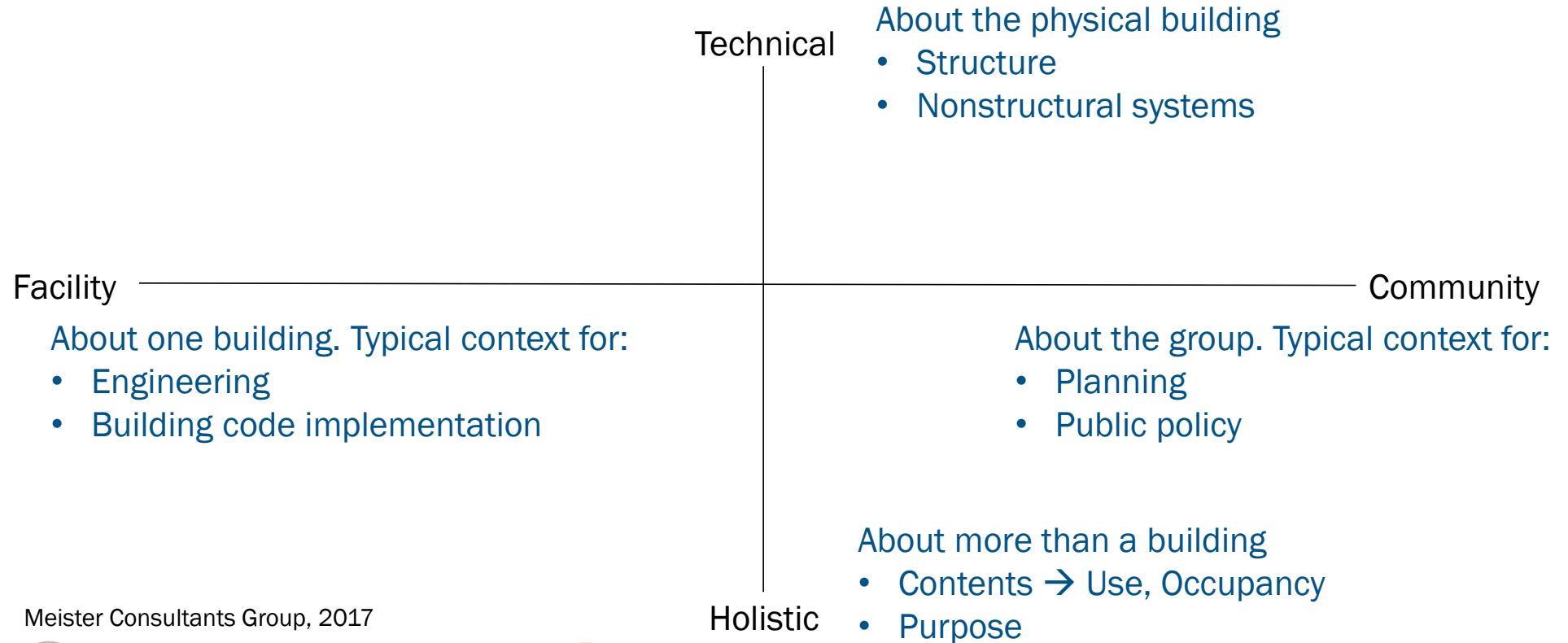

Meister Consultants Group, 2017



FEMA



Building Seismic Safety Council



The “Resilience Field”

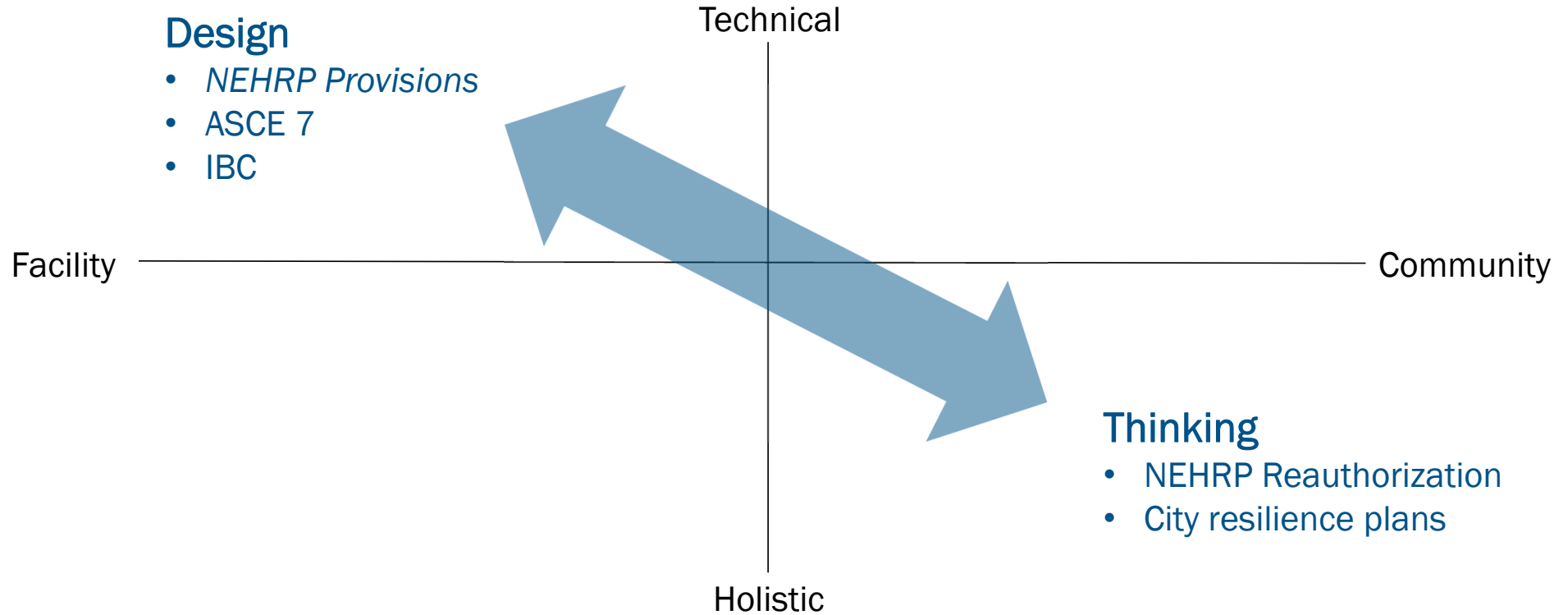

FEMA



Building Seismic
Safety Council



FR : Building : CR : Community

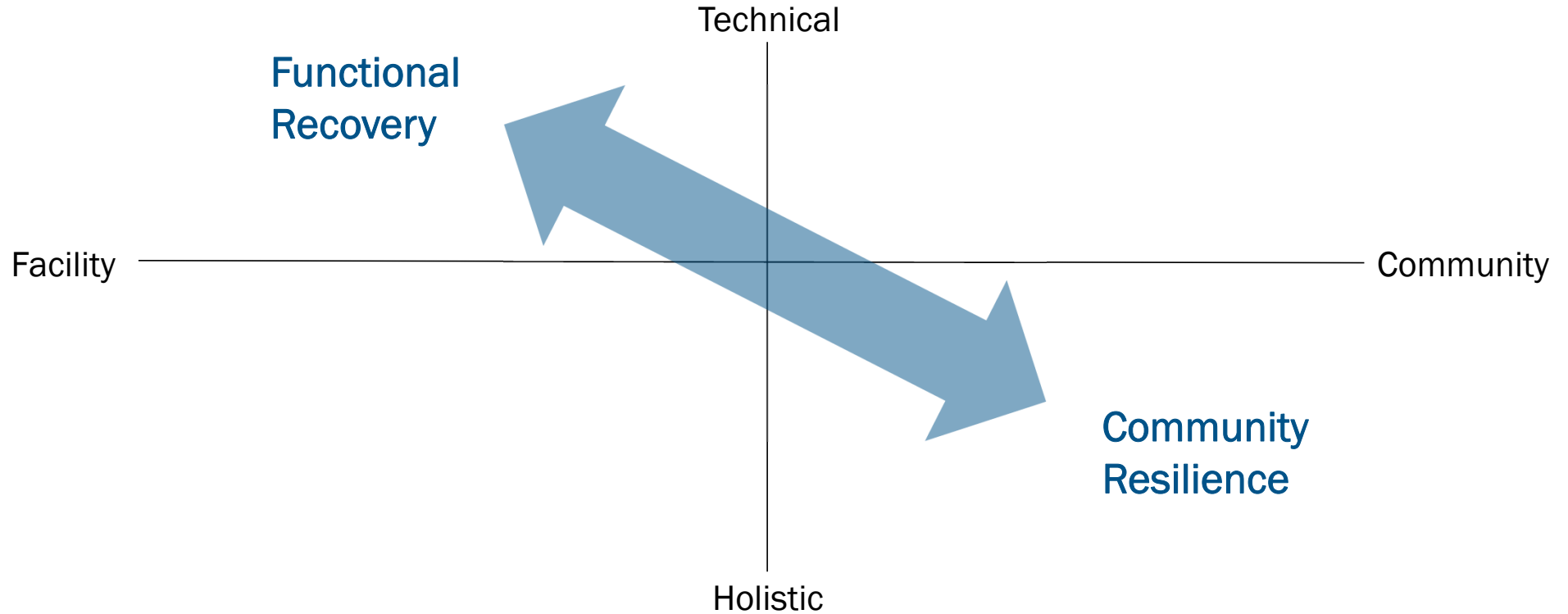

FEMA



Building Seismic
Safety Council



“Resilience-Based Design and the *NEHRP Provisions*”

- Federal policy now prioritizes earthquake resilience
- Improve resilience by designing for functional recovery
- Current “code and standard” model is promising for development of functional recovery design provisions
- NEHRP Provisions can support a functional recovery design standard



NEHRP Recommended Seismic Provisions for New Buildings and Other Structures

Volume II: Part 3 Resource Papers

FEMA P-2082-2/ September 2020



FEMA

 Building Seismic
Safety Council



New definitions: Functional Recovery

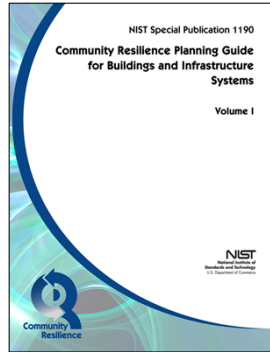

NIST, 2016

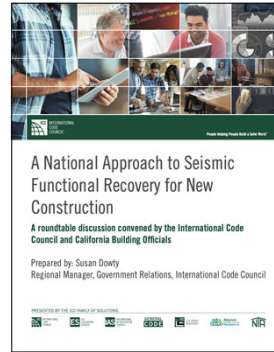

ICC, 2019

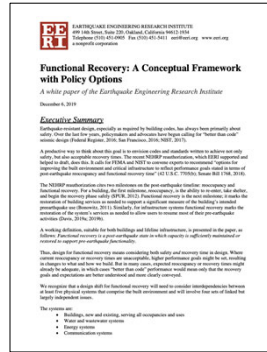

EERI, 2019

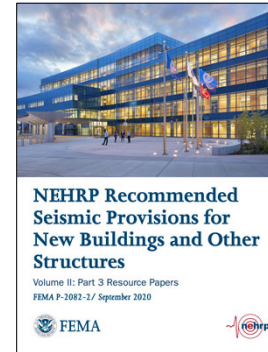

FEMA, 2020

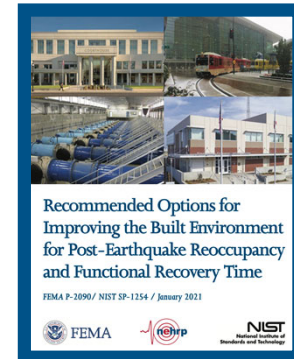

FEMA-NIST, 2021

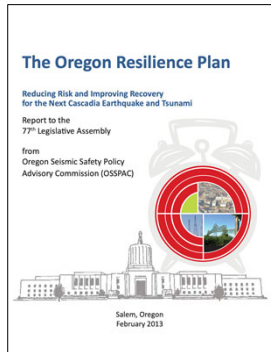

Oregon, 2013

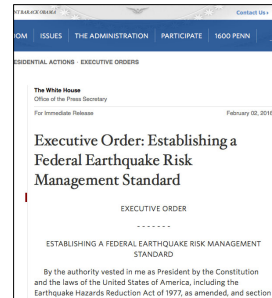

White House, 2016

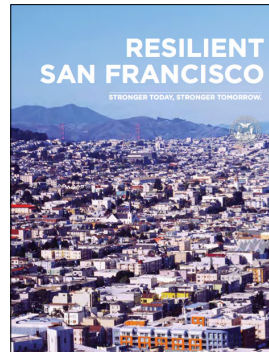

San Francisco, 2016

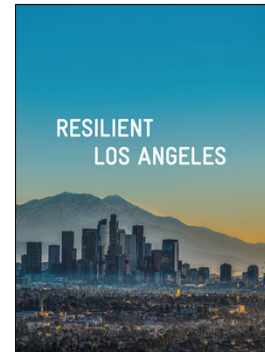

Los Angeles, 2018

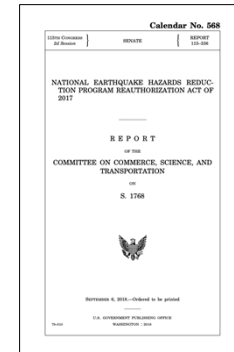

Public Law, 2018

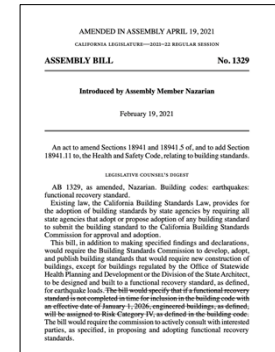

California, 2021



FEMA



Building Seismic Safety Council



FEMA-NIST definitions*

- Functional Recovery (FR) is ...
 - A post-earthquake performance state in which a building is maintained, or restored, to support the basic intended functions associated with the pre-earthquake use or occupancy.
- A Functional Recovery objective is ...
 - FR achieved within an acceptable time following a specified earthquake, where the acceptable time might differ for various building uses and occupancies.

* The FEMA-NIST definitions consider infrastructure systems as well as buildings. These versions are edited to address only buildings.



Recommended Options for Improving the Built Environment for Post-Earthquake Reoccupancy and Functional Recovery Time

FEMA P-2090 / NIST SP-1254 / January 2021



FEMA

Building Seismic Safety Council



Functional recovery and performance-based engineering

- A structural safety objective may be written as: $P(\text{collapse}) < X\%$, given $2/3 * MCE_R$

- Analogously, a functional recovery objective may be written as:

$$P(T_{FR, \text{expected}} > T_{FR, \text{acceptable}}) < Y\%, \text{ given } 2/3 * MCE_R \text{ (or other specified hazard)}$$

- Open policy questions for developers of FR codes:

- What is the acceptable or desirable FR time, $T_{FR, \text{acceptable}}$, for a given occupancy?
- What is the appropriate confidence level, Y ?
- What hazard level should be used for FR?
 - For this example, use $2/3 * MCE_R$ (See Resource Paper 1 and Design Example 2.7 for discussion.)



The technical question

$$P(T_{FR, \text{expected}} > T_{FR, \text{acceptable}}) < Y\%, \text{ given } 2/3 * MCE_R \text{ (or other specified hazard)}$$

- For a given building, what is the expected functional recovery time, $T_{FR, \text{expected}}$?
 - The subject of ongoing research, using analysis and testing
 - Also answerable by judgment, experience (reconnaissance research), and, in the interim, with our established consensus procedures for developing codes and standards.

Q: Can't we ask a similar question about safety? How do we know a given design is "safe"?

A: Yes. Current design provisions in the NEHRP Provisions, ASCE standards, and building codes reflect engineering consensus applied to collected research, judgment, and experience. The same approach can be used to develop provisions for functional recovery design.



FEMA



Building Seismic
Safety Council



Functional recovery and the current building code

- Risk Category IV (IBC Table 1604.5)
 - Used for “essential facilities” to preserve functionality after a design earthquake (NEHRP Provisions Section 1.1.5)
 - Could be used as interim FR criteria
- Two differences between FR and RC IV
 - RC IV presumes immediate performance; some FR objectives would allow time for repairs
 - FR provisions might cover externalities the current building code ignores

TABLE 1604.5
RISK CATEGORY OF BUILDINGS AND OTHER STRUCTURES

RISK CATEGORY	NATURE OF OCCUPANCY
I	Buildings and other structures that represent a low hazard to human life in the event of failure, including but not limited to: <ul style="list-style-type: none"> • Agricultural facilities. • Certain temporary facilities. • Minor storage facilities.
II	Buildings and other structures except those listed in Risk Categories I, III and IV.
III	Buildings and other structures that represent a substantial hazard to human life in the event of failure, including but not limited to: <ul style="list-style-type: none"> • Buildings and other structures whose primary occupancy is public assembly with an occupant load greater than 300. • Buildings and other structures containing Group E occupancies with an occupant load greater than 250. • Buildings and other structures containing educational occupancies for students above the 12th grade with an occupant load greater than 500. • Group I-2 occupancies with an occupant load of 50 or more resident care recipients but not having surgery or emergency treatment facilities. • Group I-3 occupancies. • Any other occupancy with an occupant load greater than 5,000.^a • Power-generating stations, water treatment facilities for potable water, wastewater treatment facilities and other public utility facilities not included in Risk Category IV. • Buildings and other structures not included in Risk Category IV containing quantities of toxic or explosive materials that: <ul style="list-style-type: none"> Exceed maximum allowable quantities per control area as given in Table 307.1(1) or 307.1(2) or per outdoor control area in accordance with the <i>International Fire Code</i>; and Are sufficient to pose a threat to the public if released.^b
IV	Buildings and other structures designated as essential facilities, including but not limited to: <ul style="list-style-type: none"> • Group I-2 occupancies having surgery or emergency treatment facilities. • Fire, rescue, ambulance and police stations and emergency vehicle garages. • Designated earthquake, hurricane or other emergency shelters. • Designated emergency preparedness, communications and operations centers and other facilities required for emergency response. • Power-generating stations and other public utility facilities required as emergency backup facilities for Risk Category IV structures. • Buildings and other structures containing quantities of highly toxic materials that: <ul style="list-style-type: none"> Exceed maximum allowable quantities per control area as given in Table 307.1(2) or per outdoor control area in accordance with the <i>International Fire Code</i>; and Are sufficient to pose a threat to the public if released.^b • Aviation control towers, air traffic control centers and emergency aircraft hangars. • Buildings and other structures having critical national defense functions. • Water storage facilities and pump structures required to maintain water pressure for fire suppression.



FEMA

Building Seismic Safety Council



CLT Shear Wall Design Example (Chapter 6)

- 6-unit townhouse
 - Multi-family residential (R-2) occupancy
 - Occupant load less than 50
 - Risk Category II
 - Seismic Design Category D
- Similar structure could be used for:
 - Assisted living, or housing for other vulnerable tenants
 - Office suites
 - Mixed use or live/work units

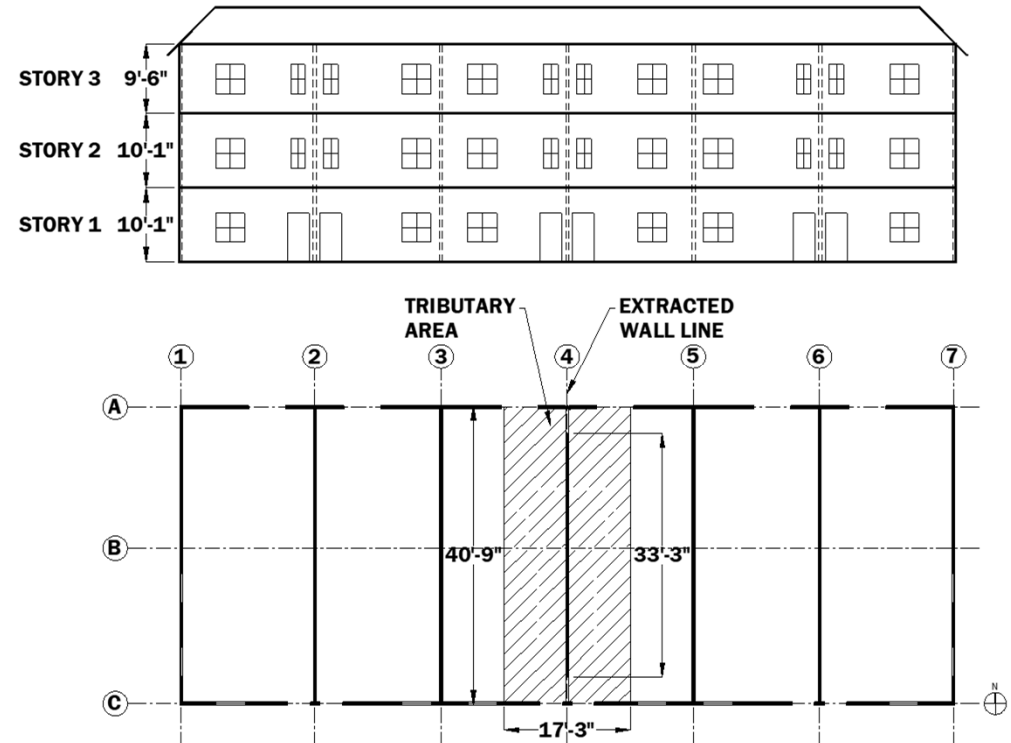

FEMA

Building Seismic
Safety Council



CLT Shear Wall Design Example (Chapter 6)

- Expected structural damage
 - Low R -factor
 - Inelasticity limited to replaceable ductile steel connectors
 - CLT tests showed no hard-to-repair damage
- Expected nonstructural damage
 - Residential systems typically lighter, less fragile than in office or other occupancies
 - For RC II buildings, current code exempts most components from anchorage because they pose no safety hazards

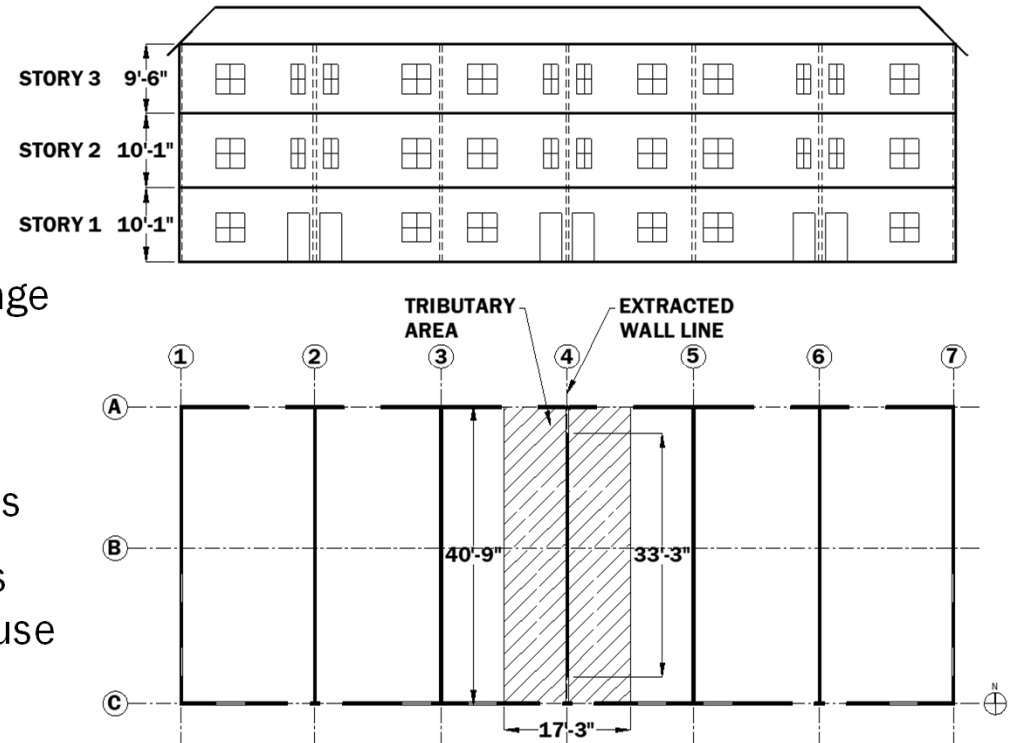

FEMA



Building Seismic
Safety Council



Functional recovery objective

- Presumed hazard: $2/3 * MCE_R$
- What is an acceptable FR time ($T_{FR, acceptable}$)?
 - Or *desired* FR time, absent code requirements
- What is the actual expected FR time ($T_{FR, expected}$)?

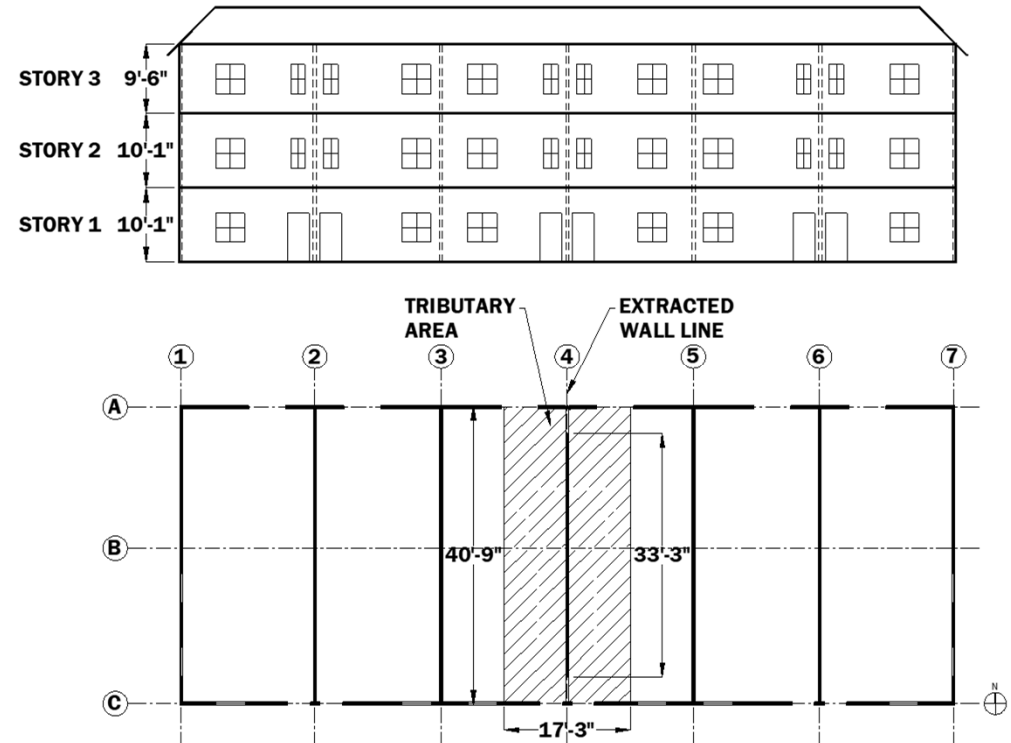

FEMA



Building Seismic
Safety Council



Policy precedents for acceptable FR time?

- NIST CRPG: 1 to 12 weeks for most housing, 3 days for vulnerable tenants
- SPUR, cited by San Francisco: Usable within a day of M7.2 event
- FEMA-NIST: "Days to weeks"
- ASCE 7: RC IV (immediate FR) should be considered where damage would cause "substantial economic impact" or "mass disruption" of normal community functions.
 - Does this apply to housing?
 - Consider pandemic lessons: is housing essential?



FEMA



Building Seismic
Safety Council



Functional recovery objective

- Presumed hazard: $2/3 * MCE_R$
- What is an acceptable FR time ($T_{FR, \text{acceptable}}$)?
 - A few weeks, at most a month?
- What is the actual expected FR time ($T_{FR, \text{expected}}$)?

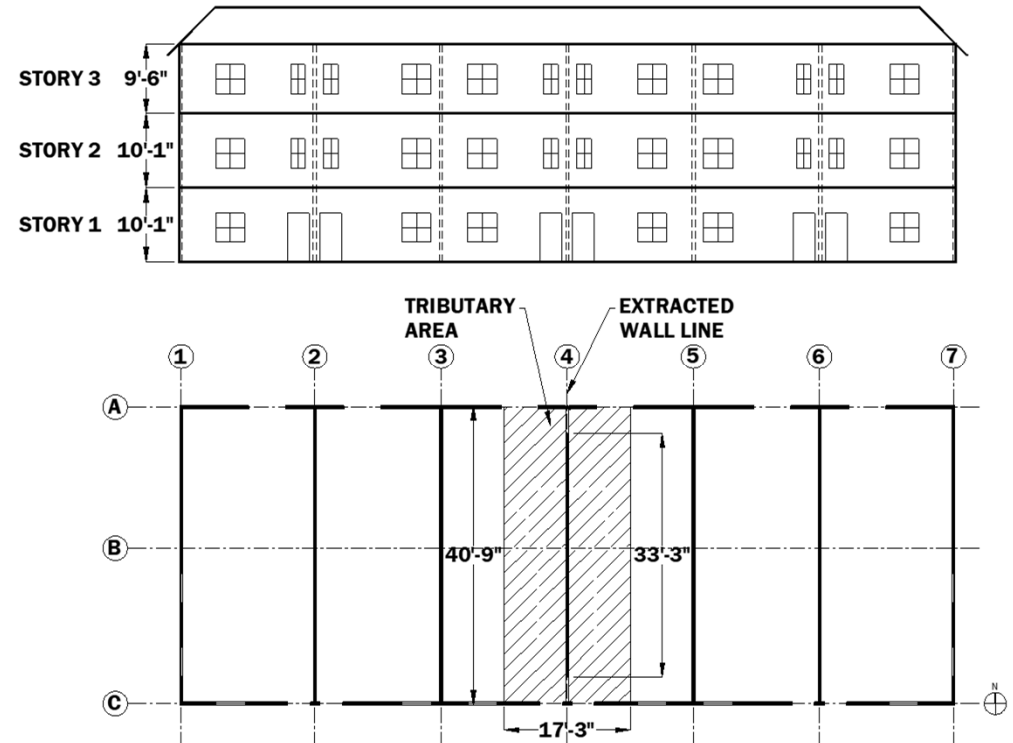

FEMA

Building Seismic
Safety Council



Expected FR time: What does current research say?

- FEMA P-58 (2018)
 - 5 concrete and steel systems;
nonstructural for office occupancy
 - 5- to 13-story model buildings
 - High seismicity sites
- Repair time after $2/3 * MCE_R$ event
 - 15 - 81 days
 - Does *not* include time for permitting, financing, mobilization, etc.
 - 12 - 33 days even if designed as RC IV
- FR time can be less than repair time

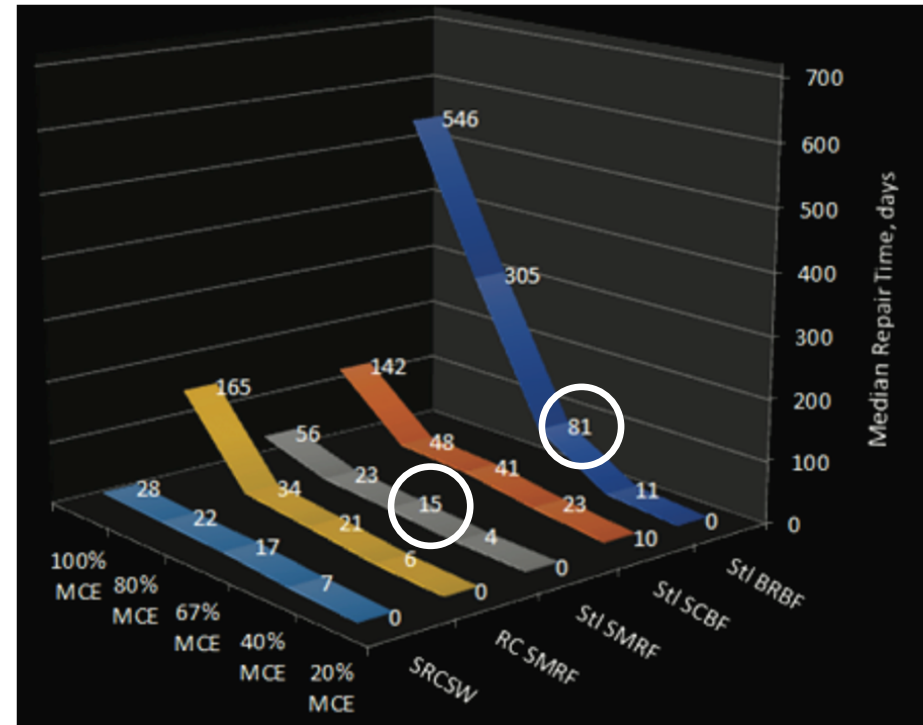

Risk Category II, Office



FEMA

Building Seismic
Safety Council



Expected FR time: What does current research say?

- Haselton et al. (2021)
 - 5 woodframe residential model buildings (not CLT); nonstructural typical for woodframe residential occupancy
 - High seismicity site
- FR time after $2/3 * MCE_R$ event
 - 3-story building: 1 – 6 months
 - Includes time for permitting, financing, mobilization, etc.

Building Type	Los Angeles Site (High-Seismicity)		
	Reoccup.	Functional Recovery	Full Repair
1-story (single-family)	0-1 wks.	0-1 wks.	1-6 mo.
2-story (single-family)	1-4 wks.	1-4 wks.	4-12 mo.
3-story (12-plex)	1-4 wks.	1-6 mo.	4-12 mo.
4-story (apartments)	1-4 wks.	1-6 mo.	1+ years
5-story (apartments)	1-4 wks.	4-12 mo.	1+ years
5-story on podium (apt.)	1-4 wks.	4-12 mo.	1+ years



Expected FR time: What does current research say?

- Furley et al. (2021)
 - 2-story office building
 - Post-tensioned CLT rocking walls w/ UFP hysteretic dissipators; nonstructural systems for office occupancy
- FR time after $2/3 * MCE_R$ event ($S_{DS} = 1.0g$)
 - ~135 days, w/ 10% probability of exceedance
 - But also ~95 days for just reoccupancy
 - Includes time for permitting, financing, mobilization, etc.
 - FR time driven by nonstructural damage.

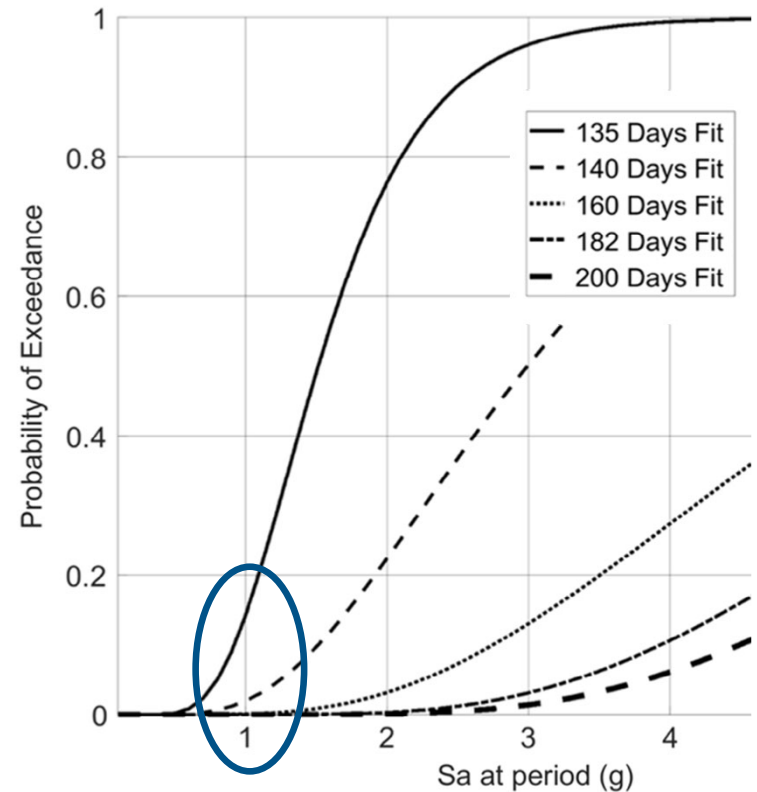

FEMA

Building Seismic
Safety Council



Expected FR time: What does current research say?

- Summary: Expected FR time after $2/3 * MCE_R$ event
 - At least a few weeks, perhaps a few months
 - FR time for different seismic force-resisting systems varies widely
 - Effect of nonstructural damage on FR time can be substantial
 - Using RC IV criteria helps, but to an unknown degree
- Work to establish reliable predictive tool continues
 - Academia (PEER, CRCRP, etc.)
 - Government agencies (FEMA, NIST, etc., w/ ATC, etc.)
 - Professional associations (SEAOC, etc.)
 - Private sector

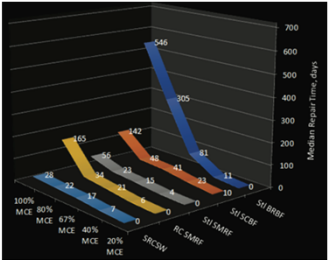

Building Type	Los Angeles Site (High-Seismicity)		
	Reoccup.	Functional Recovery	Full Repair
1-story (single-family)	0-1 wks.	0-1 wks.	1-6 mo.
2-story (single-family)	1-4 wks.	1-4 wks.	4-12 mo.
3-story (12-plex)	1-4 wks.	1-6 mo.	4-12 mo.
4-story (apartments)	1-4 wks.	1-6 mo.	1+ years
5-story (apartments)	1-4 wks.	4-12 mo.	1+ years
5-story on podium (apt.)	1-4 wks.	4-12 mo.	1+ years

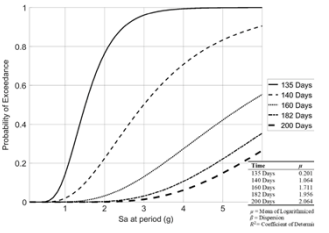

FEMA

Building Seismic Safety Council



Functional recovery objective

- Presumed hazard: $2/3 * MCE_R$
- What is an acceptable FR time ($T_{FR, acceptable}$)?
 - A few weeks, at most a month?
- What is the actual expected FR time ($T_{FR, expected}$)?
 - Several months?

Q: How to address this discrepancy?

A: Review CLT design criteria.

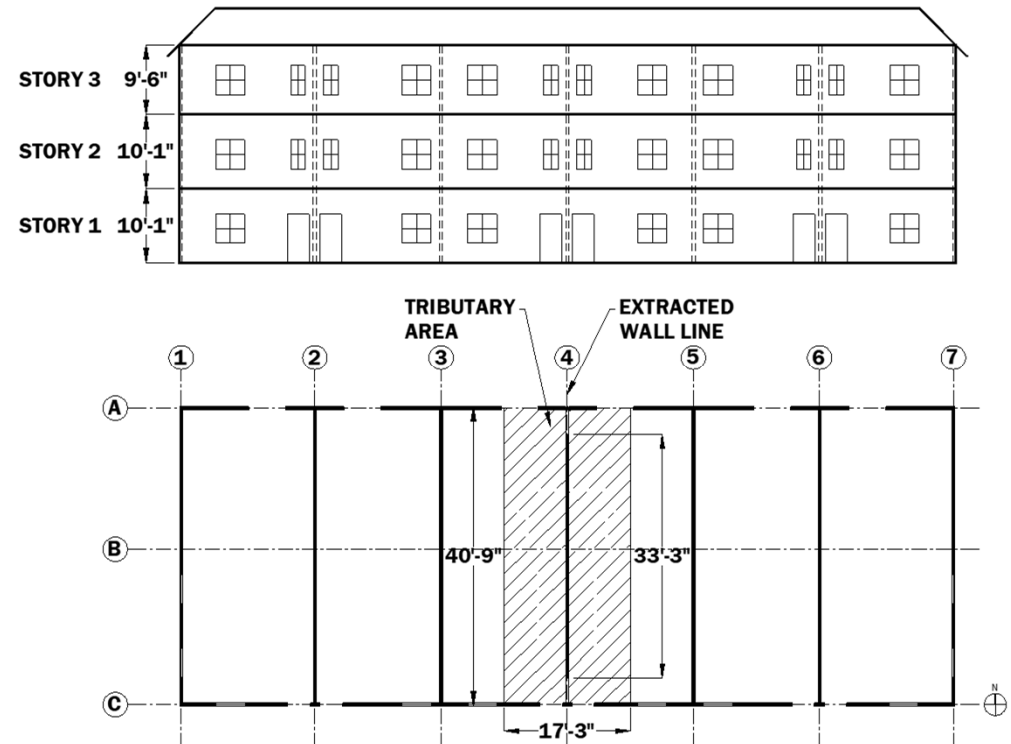

FEMA

Building Seismic
Safety Council



CLT Shear Wall structural design criteria

- Generally low damage already expected, so limited opportunities for improvement
- System selection is important; “Low damage design” beneficial for fast FR

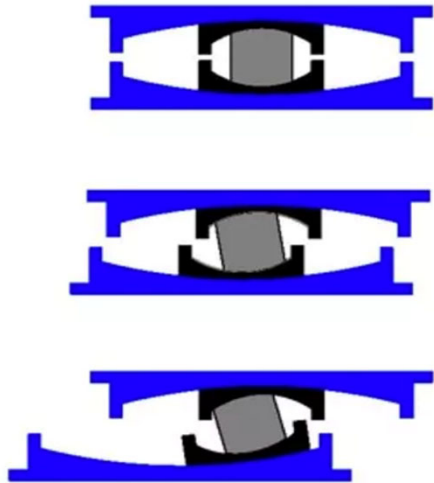

Earthquake Protection Systems

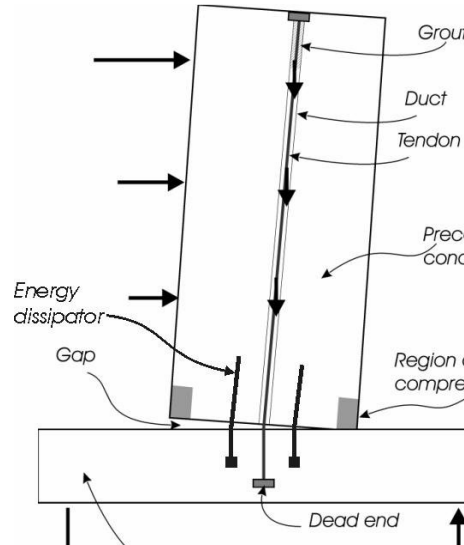

Restrepo, in Filiatrault, 2004

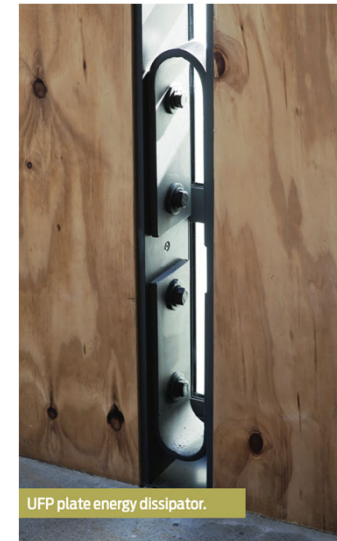

UFP plate energy dissipator.

Hogg, 2013

CLT Shear Wall structural design criteria

- Seismic importance factor, I_e 
 - A tool provided by the code, usually taken as 1.0 for residential occupancy
 - Higher value can be used, but full RC IV performance requires more than $I_e > 1.0$.
- Height limit for CLT shear wall systems
 - Design example $H = 30'$, already well under 65-ft code limit
- Response modification coefficient, R
 - Already limited to $R = 3$, a relatively low value that already limits expected inelasticity
- CLT material grade
 - Not likely to affect performance, since design is controlled by strength of connectors



FEMA



Building Seismic
Safety Council



CLT Shear Wall structural design criteria

- CLT partition classification
 - Unintended partition strength and stiffness beneficial, but difficult to codify
 - More effective to focus on intended shear walls
- Steel connector capacity 
 - Lower presumed (or prescribed) capacity would reduce damage
 - But artificially low presumed capacity could interfere with test-validated design procedure
- Drift limit
 - Unlikely to affect performance, since predicted drift is already well under current limit



FEMA



Building Seismic
Safety Council



CLT Shear Wall structural design criteria

- Hold-down deformation limit
 - Unlikely to affect performance, since predicted elongation is already well under current limit
- Hold-down design force
 - Unlikely to affect performance, since design force is set only to ensure yielding in steel connectors
- CLT panel aspect ratio
 - Unlikely to affect performance, since current design already uses low R value
 - For other designs, prohibiting higher R value for high aspect ratio panels could reduce inelasticity demands and damage



FEMA



Building Seismic
Safety Council



Townhouse nonstructural design criteria

- Not addressed in CLT Design Example
 - But expected to have significant effect on building FR time
 - Even more significant for a low-damage structural system like CLT shear walls
- Current code for RC II buildings
 - Functionality considered for life safety systems (alarms, exit lighting, sprinklers)
 - Other components exempt from protection because they pose no safety hazards

TABLE 1604.5
RISK CATEGORY OF BUILDINGS AND OTHER STRUCTURES

RISK CATEGORY	NATURE OF OCCUPANCY
I	Buildings and other structures that represent a low hazard to human life in the event of failure, including but not limited to: <ul style="list-style-type: none"> • Agricultural facilities. • Certain temporary facilities. • Minor storage facilities.
II	Buildings and other structures except those listed in Risk Categories I, III and IV.
III	Buildings and other structures that represent a substantial hazard to human life in the event of failure, including but not limited to: <ul style="list-style-type: none"> • Buildings and other structures whose primary occupancy is public assembly with an occupant load greater than 300. • Buildings and other structures containing Group E occupancies with an occupant load greater than 250. • Buildings and other structures containing educational occupancies for students above the 12th grade with an occupant load greater than 500. • Group I-2 occupancies with an occupant load of 50 or more resident care recipients but not having surgery or emergency treatment facilities. • Group I-3 occupancies. • Any other occupancy with an occupant load greater than 5,000.^a • Power-generating stations, water treatment facilities for potable water, wastewater treatment facilities and other public utility facilities not included in Risk Category IV. • Buildings and other structures not included in Risk Category IV containing quantities of toxic or explosive materials that: <ul style="list-style-type: none"> Exceed maximum allowable quantities per control area as given in Table 307.1(1) or 307.1(2) or per outdoor control area in accordance with the <i>International Fire Code</i>; and Are sufficient to pose a threat to the public if released.^b
IV	Buildings and other structures designated as essential facilities, including but not limited to: <ul style="list-style-type: none"> • Group I-2 occupancies having surgery or emergency treatment facilities. • Fire, rescue, ambulance and police stations and emergency vehicle garages. • Designated earthquake, hurricane or other emergency shelters. • Designated emergency preparedness, communications and operations centers and other facilities required for emergency response. • Power-generating stations and other public utility facilities required as emergency backup facilities for Risk Category IV structures. • Buildings and other structures containing quantities of highly toxic materials that: <ul style="list-style-type: none"> Exceed maximum allowable quantities per control area as given in Table 307.1(2) or per outdoor control area in accordance with the <i>International Fire Code</i>; and Are sufficient to pose a threat to the public if released.^b • Aviation control towers, air traffic control centers and emergency aircraft hangars. • Buildings and other structures having critical national defense functions. • Water storage facilities and pump structures required to maintain water pressure for fire suppression.



Townhouse nonstructural design criteria

- Current code for RC IV buildings
 - Broader scope of bracing, anchorage
 - Importance factor $I_p = 1.5$
 - Backup utility service
- 2020 NEHRP Provisions Section 1.1.5
 - Eight characteristics of expected RC IV performance
 - Focus on “essential functions”
 - Useful reference for voluntary FR improvement

TABLE 1604.5
RISK CATEGORY OF BUILDINGS AND OTHER STRUCTURES

RISK CATEGORY	NATURE OF OCCUPANCY
I	Buildings and other structures that represent a low hazard to human life in the event of failure, including but not limited to: <ul style="list-style-type: none"> • Agricultural facilities. • Certain temporary facilities. • Minor storage facilities.
II	Buildings and other structures except those listed in Risk Categories I, III and IV.
III	Buildings and other structures that represent a substantial hazard to human life in the event of failure, including but not limited to: <ul style="list-style-type: none"> • Buildings and other structures whose primary occupancy is public assembly with an occupant load greater than 300. • Buildings and other structures containing Group E occupancies with an occupant load greater than 250. • Buildings and other structures containing educational occupancies for students above the 12th grade with an occupant load greater than 500. • Group I-2 occupancies with an occupant load of 50 or more resident care recipients but not having surgery or emergency treatment facilities. • Group I-3 occupancies. • Any other occupancy with an occupant load greater than 5,000.^a • Power-generating stations, water treatment facilities for potable water, wastewater treatment facilities and other public utility facilities not included in Risk Category IV. • Buildings and other structures not included in Risk Category IV containing quantities of toxic or explosive materials that: <ul style="list-style-type: none"> Exceed maximum allowable quantities per control area as given in Table 307.1(1) or 307.1(2) or per outdoor control area in accordance with the <i>International Fire Code</i>; and Are sufficient to pose a threat to the public if released.^b
IV	Buildings and other structures designated as essential facilities, including but not limited to: <ul style="list-style-type: none"> • Group I-2 occupancies having surgery or emergency treatment facilities. • Fire, rescue, ambulance and police stations and emergency vehicle garages. • Designated earthquake, hurricane or other emergency shelters. • Designated emergency preparedness, communications and operations centers and other facilities required for emergency response. • Power-generating stations and other public utility facilities required as emergency backup facilities for Risk Category IV structures. • Buildings and other structures containing quantities of highly toxic materials that: <ul style="list-style-type: none"> Exceed maximum allowable quantities per control area as given in Table 307.1(2) or per outdoor control area in accordance with the <i>International Fire Code</i>; and Are sufficient to pose a threat to the public if released.^b • Aviation control towers, air traffic control centers and emergency aircraft hangars. • Buildings and other structures having critical national defense functions. • Water storage facilities and pump structures required to maintain water pressure for fire suppression.



Characteristics of RC IV functionality (*NEHRP Provisions Section 1.1.5*)

- Immediate reoccupancy
 - Largely a function of structural performance; see above.
 - Also a function of fire safety and hazmat protection, already provided by code for RC II
- Functional equipment for “essential functions” 
 - For residential building, housing code habitability standards are useful reference
 - Light, ventilation, power, potable water, heat in winter, sanitation, cooking and food storage
 - For some tenants, elevators and communications systems
 - Difference between FR and RC IV: FR might not require these to be available immediately
 - Some of these are even waived after large events to facilitate basic reoccupancy



Characteristics of RC IV functionality (*NEHRP Provisions Section 1.1.5*)

- Limited damage to contents for “essential functions” 
 - Contents are not usually considered by building code, but can be important for FR
 - For residential building, could include kitchen appliances, etc.
- For non-essential equipment and contents, no damage affecting “essential functions”
 - Might include extensive damage to architectural components (glass, ceilings)
 - Often repairable (or removable) within desired FR time
- Building envelope “maintains integrity ... To preserve essential functions.”
 - Mostly already covered by code for RC II (glazing, cladding, roofing)
 - Repair can often be done from exterior with limited effect on functional recovery



Characteristics of RC IV functionality (*NEHRP Provisions Section 1.1.5*)

- Only “minor leakage” in “piping carrying nontoxic substances” ←
 - Intent seems clear, but subject to broad interpretation
- “Controlled” release of toxic substances
 - Intent seems clear, but subject to broad interpretation
 - Unlikely to be an issue in new residential buildings
- Egress “maintained”
 - Needed for basic reoccupancy as well
 - Mostly covered by code for RC II (drift limits, protection from falling hazards, lighting)
 - Could apply to special accessibility features or equipment ←



Voluntary FR and emerging best practices

- Basic strategies for improving FR time
 - SFRS selection: Low-damage design
 - Drift limits
 - Nonstructural & contents scope
 - Quality assurance
 - Planning strategies
- Needed tools
 - Consensus design criteria
 - Design and analysis software



Casa Adelante, San Francisco



FEMA

Building Seismic
Safety Council



Voluntary FR and emerging best practices

Project	Building Use	Functional Recovery Objective or Expectation	Recovery-focused Design Features or Criteria
181 Fremont (Almufti et al., 2016)	Office high-rise	Within weeks after design EQ	Reinforced concrete core, designed w/ ARUP's REDi criteria
Beaverton, OR schools (SEFT, 2015)	Public schools	RC IV performance, to suit services as post-EQ shelter	RC IV criteria, backup generator
UCSF Mission Hall (Bade, 2014)	University offices	Operational performance after 84th percentile Hayward event	Enhanced RC II criteria, concrete shear walls
Casa Adelante (Mar, 2021)	Senior housing	Within 1 day after 475-year event, no tenant relocation	Rocking walls, dampers
85 Bluxome (Moore, 2021)	Office mid-rise	Within "days to weeks" after "major EQ"	Tight drift limits (zero lot lines), SidePlate moment-resisting frame



Voluntary FR and emerging best practices

Project	Building Use	Functional Recovery Objective or Expectation	Recovery-focused Design Features or Criteria
UCSF Center for Vision Neuroscience (Berkowitz, 2021)	University research	Within 60 days after M7 San Andreas event	1.25 importance factor, 1.5% allowable drift
Oregon Treasury (Zimmerman, 2021)	Gov't offices	Within 0 days after MCE_R	Base isolation, minimized nonstructural components
Stanford Biomedical Innovations (Lizundia, 2021)	University research	Within 26 days after 475-year event	Modified RC III criteria, element-specific R values, 1.5 importance factor
Allenby Building (Westermeyer, 2021)	Gov't offices	Within 0 days after 475-year event	Reduced drift limits, amplified demand, post-EQ recovery plan



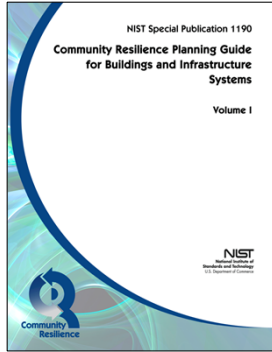

NIST, 2016

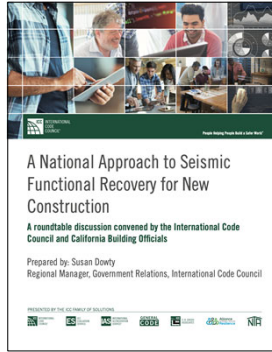

ICC, 2019



EERI, 2019

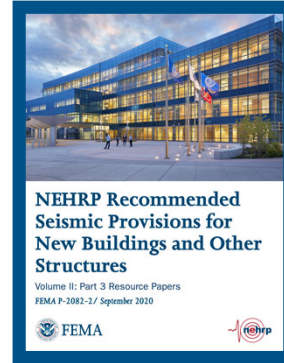

FEMA, 2020

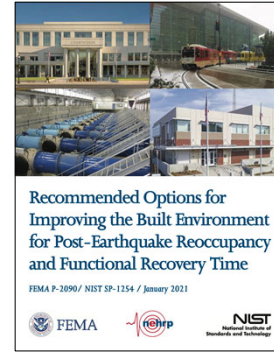

FEMA-NIST, 2021

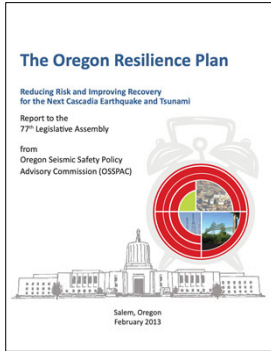

Oregon, 2013

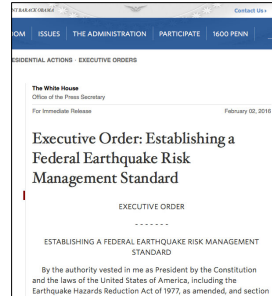

White House, 2016

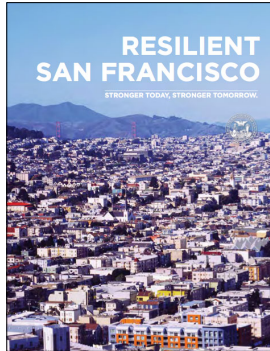

San Francisco, 2016

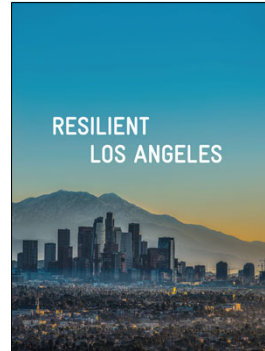

Los Angeles, 2018

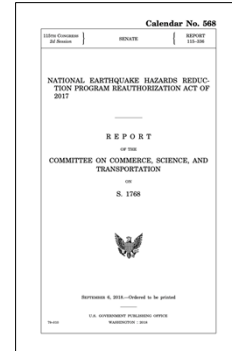

Public Law, 2018

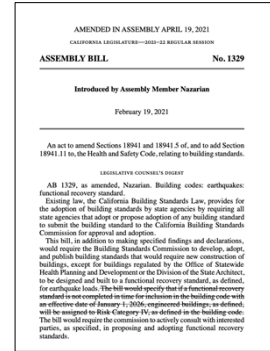

California, 2021



FEMA



Building Seismic Safety Council



References

- Almufti, I. et al. (2016). “The resilience-based design of 181 Fremont Tower,” *Structure*, June.
- Bade, M. (2014). “Mission Bay Block 25 Building – An Exercise in Lean Target Value Design,” Presentation to the Lean Construction Institute, Finland, April 12.
- Berkowitz, R. (2021). “UCSF Center for Vision Neuroscience,” 2021 EERI Annual Meeting, Session 3B, March 24.
- EERI, 2019. “Functional Recovery: A Conceptual Framework with Policy Options.” December 6. Available at eeri.org
- FEMA (2018). *Seismic Performance Assessment of Buildings: Volume 5 – Expected Seismic Performance of Code-Conforming Buildings*, FEMA P-58-5, prepared by Applied Technology Council for Federal Emergency Management Agency, December.
- FEMA (2020). *NEHRP Recommended Seismic Provisions for New Buildings and Other Structures, Volume II: Part 3 Resource Papers, 2020 Edition*, FEMA P-2082-2, prepared by the Building Seismic Safety Council of the National Institute of Buildings Sciences for Federal Emergency Management Agency, September.
- FEMA-NIST (2021). *Recommended Options for Improving the Built Environment for Post-Earthquake Reoccupancy and Functional Recovery Time*, FEMA P-2090 / NIST SP-1254, Federal Emergency Management Agency and National Institute of Standards and Technology, January.
- Filiatrault, A., et al., 2004. “Development of Self-Centering Earthquake Resisting Systems” [Paper No. 3393]. 13th World Conference on Earthquake Engineering, Vancouver, August.
- Furley, J., et al. (2020). “Time-to-Functionality Fragilities for Performance Assessment of Buildings,” *Journal of Structural Engineering*, in review.
- Haselton, C. et al. (2021). “Post-Earthquake Reoccupancy and Functional Recovery Times for New Residential Buildings in California: What do Current Codes and Building Practices Provide?” <https://sp3risk.com/2021/05/21/sp3-white-paper-on-functional-recovery-for-new-california-housing-bill-now-available/>
- Hogg, S. (2013). “Moving to low-damage design,” *Build* 134, February-March, p50-51.
- ICC (2019). “A National Approach to Seismic Functional Recovery for New Construction.” ICC publication 19-17983. Report of a “roundtable discussion” July 25, 2019.
- ICC (2020). *International Building Code, 2021 Edition*, First Printing in October 2020, International Code Council, Whittier, CA.
- Lizundia, B. (2021). “Resilient Design of the Stanford BRBF Biomedical Innovations Building,” 2021 EERI Annual Meeting, Session 3B, March 24.



FEMA

 Building Seismic
Safety Council



References

Los Angeles (2018). *Resilient Los Angeles*. City of Los Angeles, March.

Mar, D. (2021). “Making Resilience Affordable,” 2021 EERI Annual Meeting, Session 3B, March 24.

Meister Consultants Group, 2017. “Voluntary Resilience Standards: An assessment of the emerging market for resilience in the built environment.” May.

Moore, M. (2021). “The Story of San Francisco’s First USRC-Rated Building,” 2021 EERI Annual Meeting, Session 3B, March 24.

Nazarian (2021). “Assembly Bill No. 1329.” Introduced February 19. Previous versions were proposed in 2018 as AB 1857, in 2019 as AB 393, and in 2020 as AB 1997.

NIST (2016). *Community Resilience Planning Guide for Buildings and Infrastructure Systems*, NIST Special Publication 1190, National Institute of Standards and Technology, May.

OSSPAC (2013). *The Oregon Resilience Plan: Reducing Risk and Improving Recovery for the Next Cascadia Earthquake and Tsunami*, Oregon Seismic Safety Policy Advisory Committee, February.

Public Law 115-307 (2018). “Earthquake Hazards Reduction Act of 1977,” as amended. Enacted December 11.

SEFT Consulting Group (2015). “Beaverton School District Resilience Planning for High School at South Cooper Mountain and Middle School at Timberland,” SEFT Consulting Group, July 10.

SPUR (2009). “The Resilient City, Part 1: Before the disaster,” in *Urbanist*, February.

Westermeyer, J. (2021). “Resilient Design of an 11-Story Concrete Building,” 2021 EERI Annual Meeting, Session 3B, March 24.

White House (2016). “Executive Order 13717 of February 2, 2016: Establishing a Federal Earthquake Risk Management Standard,” *Federal Register*, v81, n24, February 5.

Zimmerman, R. (2021). “Resilient Design of a 2-story Seismically Base-Isolated Office Building in Salem, OR,” 2021 EERI Annual Meeting, Session 3B, March 24.



FEMA



DISCLAIMER

- NOTICE: Any opinions, findings, conclusions, or recommendations expressed in this publication do not necessarily reflect the views of the Federal Emergency Management Agency. Additionally, neither FEMA, nor any of its employees make any warranty, expressed or implied, nor assume any legal liability or responsibility for the accuracy, completeness, or usefulness of any information, product or process included in this publication.
- The opinions expressed herein regarding the requirements of the *NEHRP Recommended Seismic Provisions*, the referenced standards, and the building codes are not to be used for design purposes. Rather the user should consult the jurisdiction's building official who has the authority to render interpretation of the code.
- This training material presentation is intended to remain complete in its entirety even if used by other presenters. While the training material could be tailored for use in other presentations, we caution users to account for issues of completeness and interpretation if only part of the material is used. We also strongly suggest users give proper credit/citation to this presentation and its author.



FEMA



Building Seismic
Safety Council



Chapter 3 (Section 3.2 - Part 1)

The 2018 Update of the USGS National Seismic Hazard Model

2020 NEHRP Provisions Training Materials

Sanaz Rezaeian, Ph.D., USGS



FEMA



Building Seismic
Safety Council

BSSC



 **USGS**
science for a changing world

USGS NSHMs & BSSC PUC Requirements

Hazard Model (PSHA)

Site-specific Procedures of Ch21

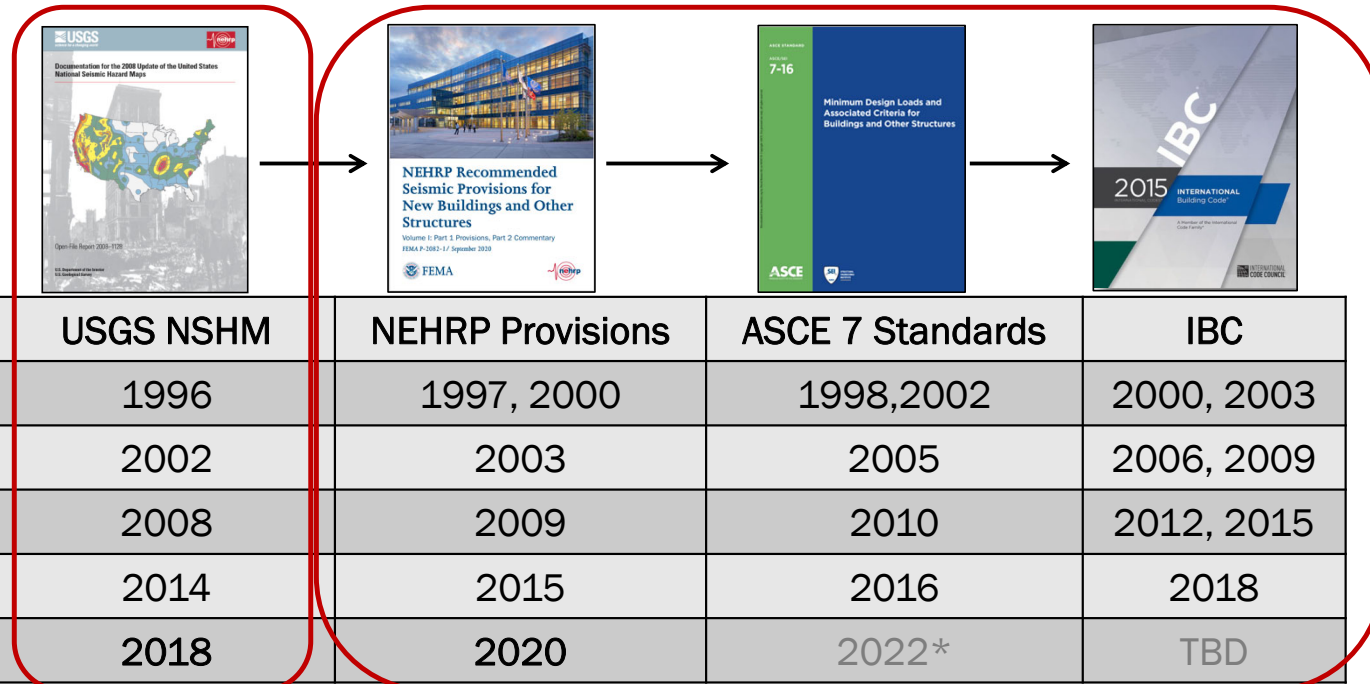

Hazard Curves- (RiskTarget, MaxDir, ~~SiteAmpl~~, DetCaps) → “Design” Ground Motions



FEMA

Building Seismic
Safety Council



Updates to 2020 NEHRP Design Ground Motions in Conterminous US

2018 USGS NSHM

Check for updates

Research paper

**EARTHQUAKE
RESPECTRA**

Earthquake Spectra
2020, Vol. 26 (1) 1–41
© The Author(s) 2019
Article reuse guidelines:
sagepub.com/journalsPermissions.nav
DOI: 10.1177/0754235219878199
journals.sagepub.com/home/eqs

The 2018 update of the US National Seismic Hazard Model: Overview of model and implications

Mark D. Petersen, M.EERI¹, Allison M. Shumway¹, Peter M. Powers, M.EERI¹, Charles S. Mueller¹, Morgan P. Moschetti, M.EERI¹, Arthur D. Frankel, M.EERI², Sarraz Rezaeian¹, Daniel E. McNamara¹, Nico Luco, M.EERI¹, Oliver S. Boyd, M.EERI¹, Kenneth S. Rukstales¹, Kishor S. Jaiswal, M.EERI¹, Eric M. Thompson¹, Susan M. Hoover¹, Brandon S. Clayton¹, Edward H. Field, M.EERI¹, and Yuehua Zeng¹

Abstract
During 2017–2018, the National Seismic Hazard Model for the conterminous United States was updated as follows: (1) an updated seismicity catalog was incorporated, which includes new earthquakes that occurred from 2013 to 2017; (2) in the central and eastern United States (CEUS), new ground motion models were updated that incorporate updated median estimates, modified assessments of the associated epistemic uncertainties and aleatory variabilities, and new soil amplification factors; (3) in the western United States (WUS), amplified shaking estimates of long-period ground motions at sites overlying deep sedimentary basins in the Los Angeles, San Francisco, Seattle, and Salt Lake City areas were incorporated; and (4) in the conterminous United States, seismic hazard is calculated for 22 periods (from 0.01 to 10 s) and 6 uniform Y_{50} maps (ranging from 1500 to 150 m/s). We also include a description of updated computer codes and modeling details. Results show increased ground shaking in many (but not all) locations across the CEUS (up to ~30%), as well as near the four urban areas overlying deep sedi-

¹US Geological Survey, Denver Federal Center, Denver, CO, USA
²US Geological Survey, University of Washington, Seattle, WA, USA

Corresponding author:
Mark D. Petersen, US Geological Survey, Denver Federal Center, P.O. Box 25046, MS 966, Denver, CO 80225, USA.
Email: mpetersen@usgs.gov



BSSC Project '17

BSSC PROJECT 17 FINAL REPORT

National Institute of BUILDING SCIENCES[®]

BSSC Project 17 Final Report

Development of Next Generation of Seismic Design Value Maps for the 2020 NEHRP Provisions



by
National Institute of Building Sciences
Building Seismic Safety Council
Project 17 Committee (chair: Ron Hamburger)

Sponsored by
Federal Emergency Management Agency

Updated site-specific procedures of Ch21

DECEMBER 2019

NATIONAL INSTITUTE OF BUILDING SCIENCES



Updates to 2020 NEHRP Design Ground Motions in Conterminous US

2018 USGS NSHM

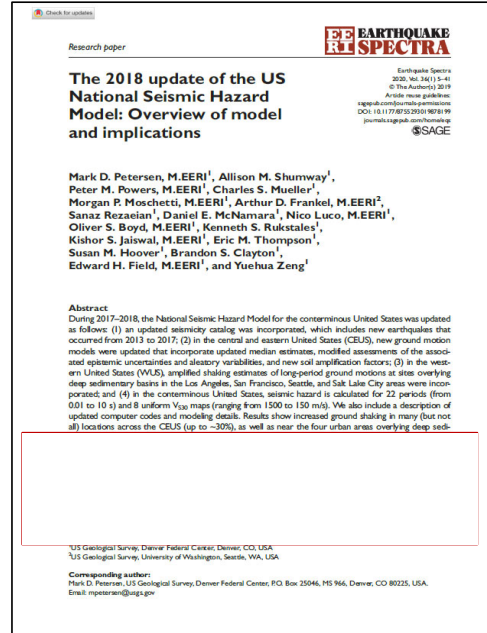

The 2018 update of the US National Seismic Hazard Model: Overview of model and implications

Mark D. Petersen, M.EERI¹, Allison M. Shumway¹, Peter M. Powers, M.EERI¹, Charles S. Mueller², Morgan P. Moschetti, M.EERI¹, Arthur D. Frankel, M.EERI², Sarraz Rezaeiian¹, Daniel E. McNamara¹, Nico Luco, M.EERI¹, Oliver S. Boyd, M.EERI¹, Kenneth S. Rukstales¹, Kishor S. Jaiswal, M.EERI¹, Eric M. Thompson¹, Susan M. Hoover¹, Brandon S. Clayton¹, Edward H. Field, M.EERI², and Yuehua Zeng¹

Abstract
During 2017–2018, the National Seismic Hazard Model for the conterminous United States was updated as follows: (1) an updated seismicity catalog was incorporated, which includes new earthquakes that occurred from 2013 to 2017; (2) in the central and eastern United States (CEUS), new ground motion models were updated that incorporate updated median estimates, modified assessments of the associated epistemic uncertainties and aleatory variabilities, and new soil amplification factors; (3) in the western United States (WUS), amplified shaking estimates of long-period ground motions at sites overlying deep sedimentary basins in the Los Angeles, San Francisco, Seattle, and Salt Lake City areas were incorporated; and (4) in the conterminous United States, seismic hazard is calculated for 22 periods (from 0.01 to 10 s) and 8 uniform Y₅₀ maps (ranging from 1500 to 150 m/s). We also include a description of updated computer codes and modeling details. Results show increased ground shaking in many (but not all) locations across the CEUS (up to ~30%), as well as near the four urban areas overlying deep sedi-

¹US Geological Survey, Denver Federal Center, Denver, CO, USA
²US Geological Survey, University of Washington, Seattle, WA, USA

Corresponding author:
Mark D. Petersen, US Geological Survey, Denver Federal Center, P.O. Box 25046, MS 966, Denver, CO 80225, USA.
Email: mpetersen@usgs.gov



BSSC Project '17

No change to risk-targeted calcs

1. Using multi-period multi-Vs30 response spectrum (MPRS)
2. Modifying deterministic caps based on deaggregation of probabilistic hazard
3. Updating the max-direction factors

MPRS issue directly influenced the 2018 update of USGS NSHM (GMMs applicable for all periods and site classes)



FEMA



Building Seismic Safety Council



Updates to 2020 NEHRP Design Ground Motions in Conterminous US

Necessary for MPRS

2018 USGS NSHM

1. New ground motion models (GMMs), including **NGA-East**, & amplification factors in the Central & Eastern US (CEUS)
2. Deep **basin effects** in Los Angeles, Seattle, San Francisco, and Salt Lake City regions
3. Minor modifications of GMMs (crustal & subduction) in the Western US (WUS)
4. Updating **background seismicity** to include 2013-2017 earthquakes



BSSC Project '17

No change to risk-targeted calcs

1. Using multi-period multi-Vs30 response spectrum (**MPRS**)
2. Modifying **deterministic caps** based on deaggregation of probabilistic hazard
3. Updating the **max-direction** factors

MPRS issue directly influenced the 2018 update of USGS NSHM (GMMs applicable for all periods and site classes)



FEMA

 Building Seismic Safety Council



science for a changing world

Old CEUS Ground Motion Models

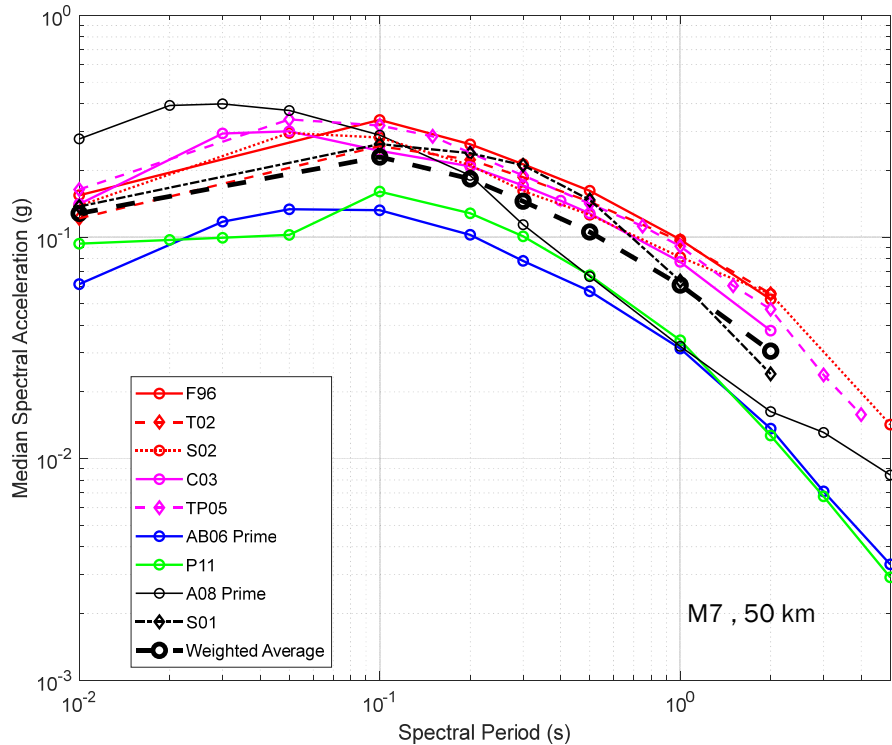

Table from Rezaeian et al. (2021):

2014 CEUS GMMs:	Period Range	Site Classes
AB06'	PGA to 5 s	A, BC (A to E)
A08'	PGA to 5 s	A, BC (A to E)
C03	PGA to 2 s (4 s)	A, BC*
F96	PGA to 2 s	A, BC
P11	PGA to 5 s (10 s)	A, BC*
S02	PGA to 5 s (10 s)	A, BC*
S01	PGA to 2 s (4 s)	A, BC*
TP05	PGA to 4 s	A, BC*
T02	PGA to 2 s	A, BC*

Parentheses indicate the published range when a different range is supported in the USGS codes.

*Through conversion factors.

Figure citation: Rezaeian et al. (2021). "The 2018 update of the US National Seismic Hazard Model: Ground motion models in the central and eastern US," *Earthquake Spectra*. doi: [10.1177/8755293021993837](https://doi.org/10.1177/8755293021993837)



FEMA



Building Seismic Safety Council



New CEUS Ground Motion Models

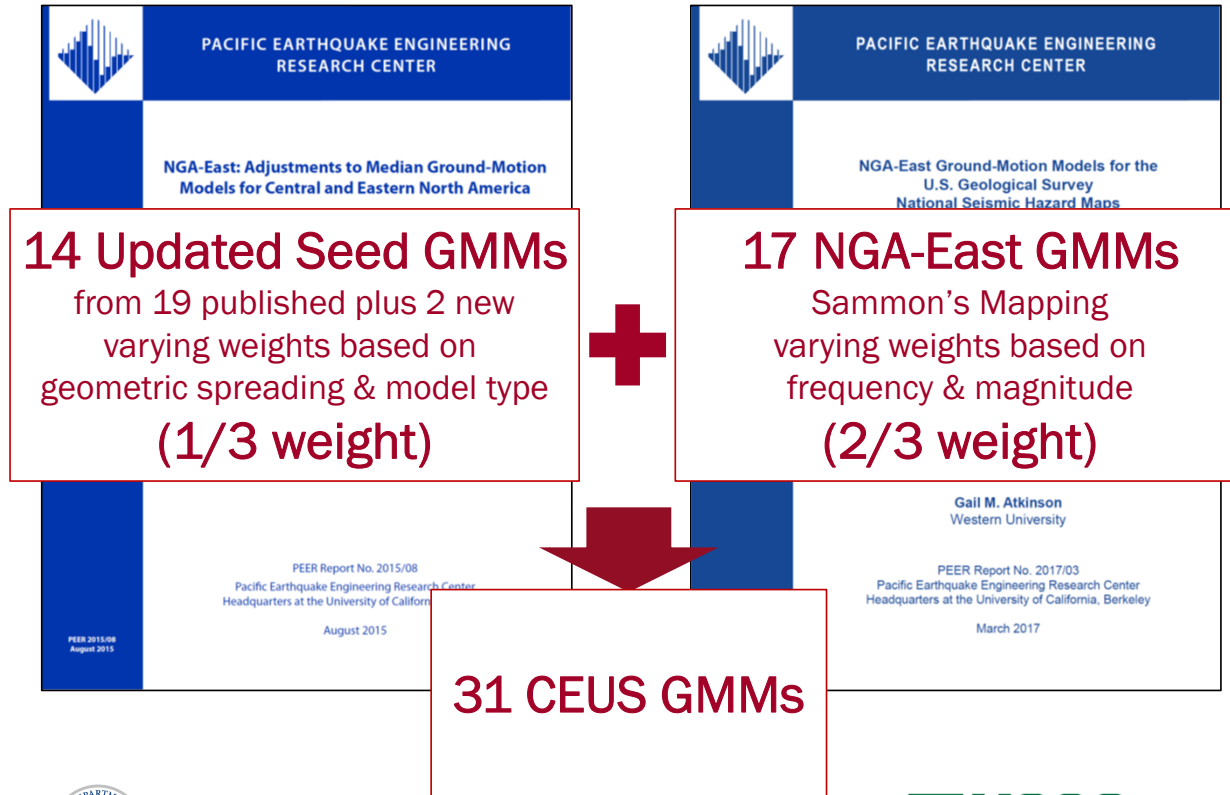

Changes made to:

1. Median ground motions (increases for large M, middle to large distances)
2. Epistemic uncertainty (increased)
3. Aleatory uncertainty (minor)



FEMA



Building Seismic Safety Council



New CEUS Ground Motion Models

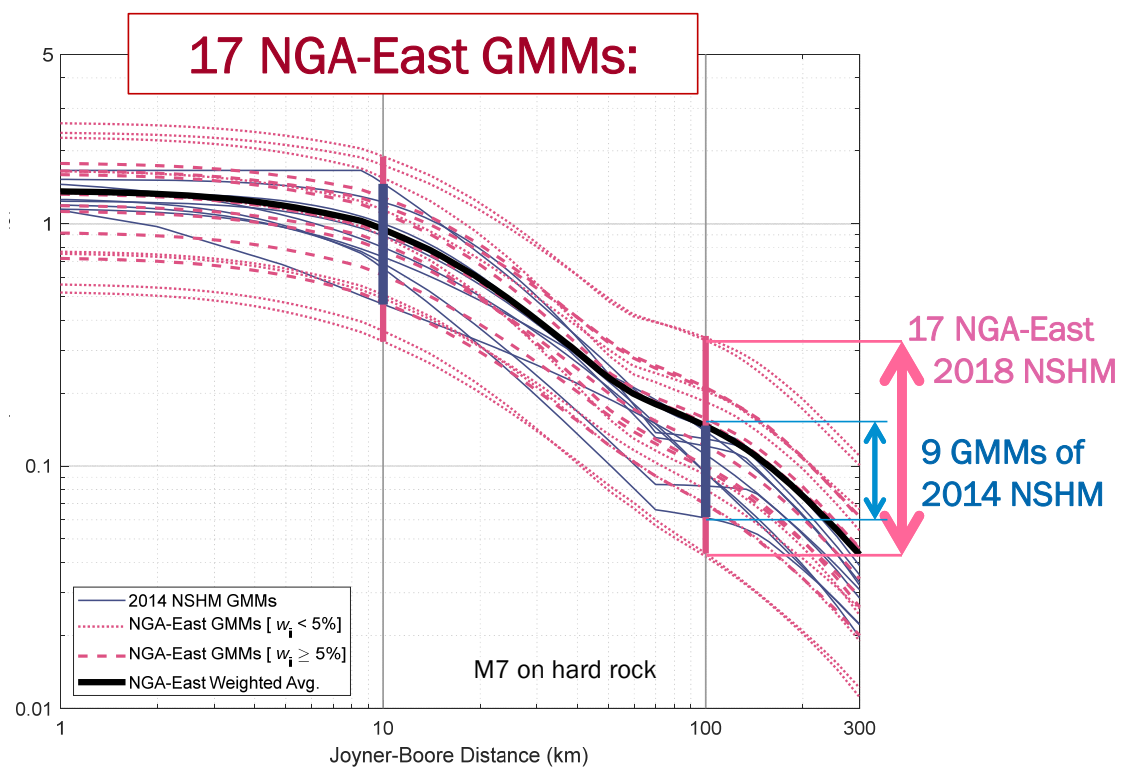
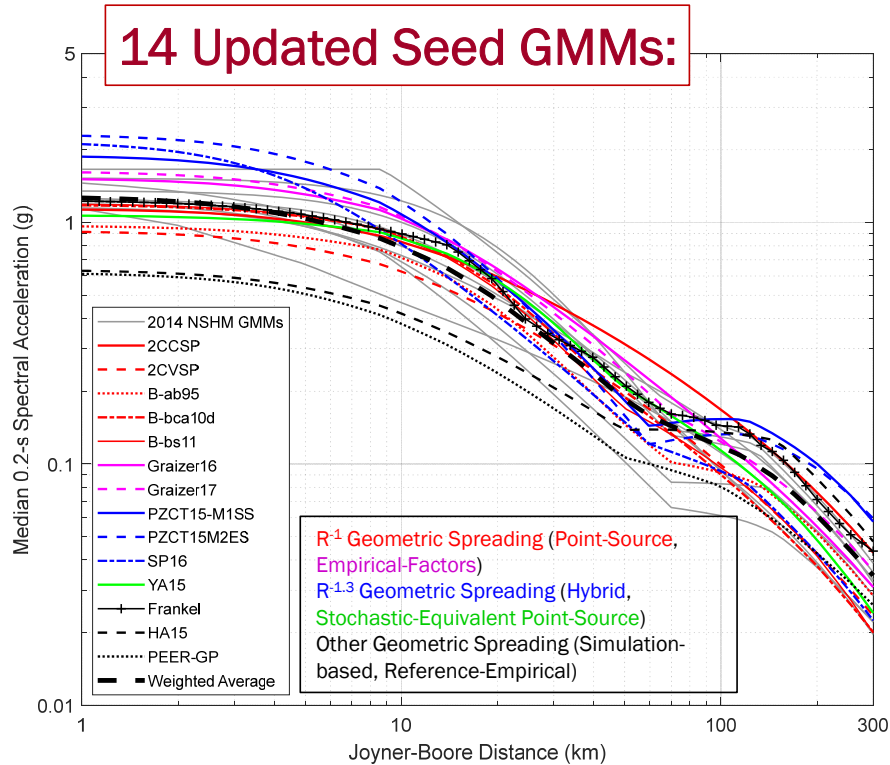

New CEUS Site-Effects Models



**PACIFIC EARTHQUAKE ENGINEERING
RESEARCH CENTER**

**Expert Panel Recommendations for
Ergodic Site Amplification in
Central and Eastern North America**

Principal Investigator and Panel Chair:
Jonathan P. Stewart
University of California, Los Angeles

Graduate Students:

Memorandum

Date: July 18, 2018 (updated July 26 2018)

To: The USGS National Seismic Hazard Mapping Project

From: Jonathan P. Stewart, Grace A. Parker, Youssef M.A. Hashash, Gail M. Atkinson, David M. Boore, Robert B. Darragh, Walter J. Silva, Okan Ilhan and Joseph A. Harmon

RE: Proposed Recommendations to the USGS on 3000 to 760 m/s Site Amplification Factors and Related Issues

University of Illinois at Urbana-Champaign

PEER Report No. 2017/04
Pacific Earthquake Engineering Research Center
Headquarters at the University of California, Berkeley

March 2017

PEER 2017/04
March 2017

$$\text{Site Effects} = F_{760} + F_{\text{linear}} + F_{\text{nonlinear}}$$

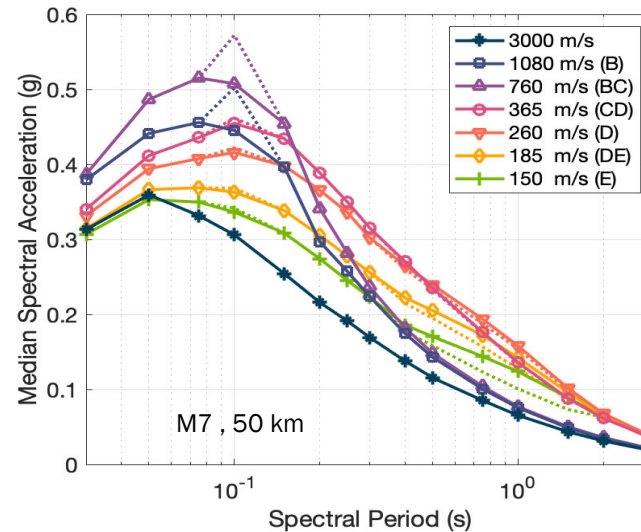

CEUS has very different spectral shapes compared to WUS, as expected!

This is the first time that site-effects specific to the CEUS have been implemented in the NSHMs (prior NEHRP coefficients were based on WUS)

Figure citation: Rezaeian et al., 2021. "The 2018 update of the US National Seismic Hazard Model: Ground motion models in the central and eastern US," *Earthquake Spectra*.

Later published (and slightly modified) by:
 Stewart et al. (2020), *Earthquake Spectra* 36(1)
 Hashash et al. (2020), *Earthquake Spectra* 36(1)
 Rezaeian et al. (2021), *Earthquake Spectra* (implementation details)



FEMA

**Building Seismic
Safety Council**



USGS
science for a changing world

Hazard Changes (CEUS)

Ratio Maps (2018/2014):

2% in 50yr uniform hazard, BC site class (760 m/s)

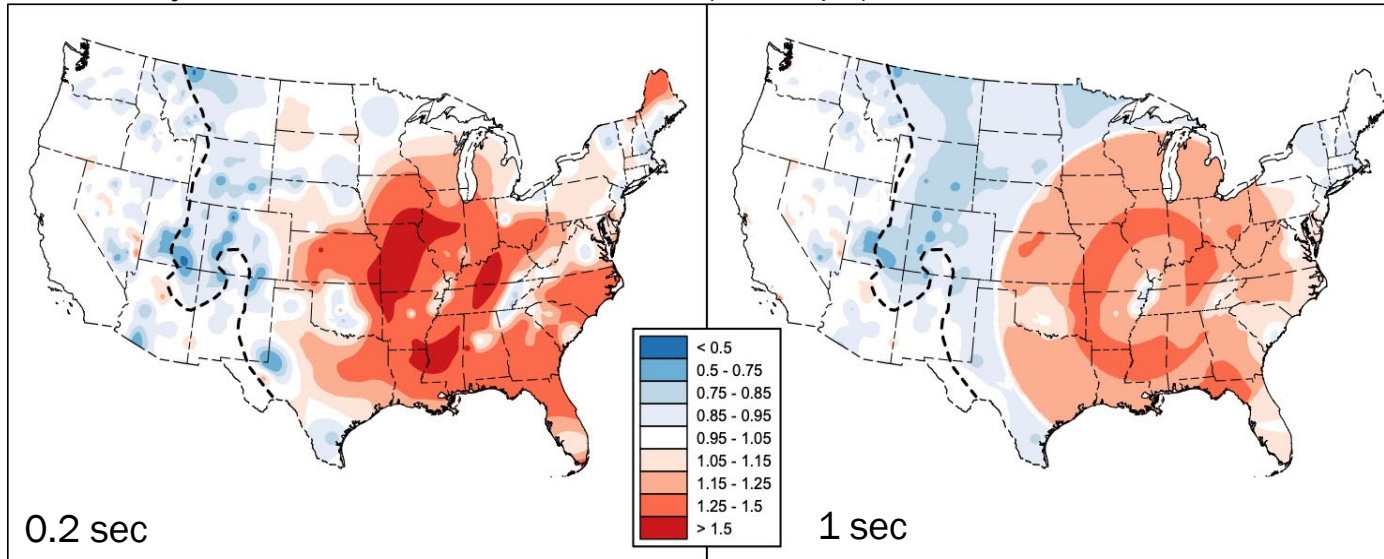

Medians: more significant increases for large M at mid-large distances

Epistemic uncertainty: increased significantly for large M, more around 70-100 km

Aleatory uncertainty: minor changes

Site-effect model: only F_{760} in this figure

Seismicity catalog updates: outside CA, mostly affecting intermountain west region

Figure citation: Petersen et al., 2021. "The 2018 update of the US National Seismic Hazard Model: Where, why, and how much probabilistic ground motion maps changed," *Earthquake Spectra*.



FEMA

Building Seismic Safety Council



USGS
science for a changing world

Deep Basin Effects

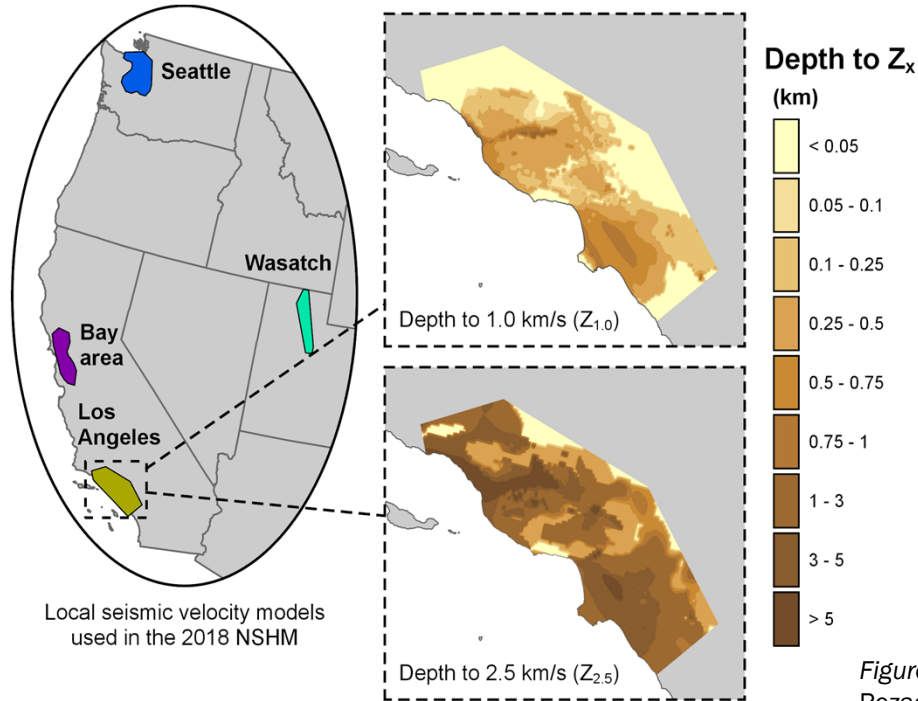

Local seismic velocity models used in the 2018 NSHM

Categorized by:
basin depth terms $Z_{1.0}$ & $Z_{2.5}$

Within basins:
measurements only in deep portions of basins are used, “default” values are used in shallow depths

Outside basins:
“default” values are used

Figure citation: Map of basin locations from Shumway AM, Petersen MD, Powers PM, Rezaeian S, Rukstales KS, Clayton BS, 2021. “The 2018 update of the US National Seismic Hazard Model: Additional period and site class data,” *Earthquake Spectra*, 37(2):1145-1161, doi:[10.1177/8755293020970979](https://doi.org/10.1177/8755293020970979).



FEMA



Building Seismic Safety Council



Deep Basin Effects

Figure citation: Powers et al., 2021. "The 2018 update of the US National Seismic Hazard Model: Ground motion models in the western US," *Earthquake Spectra*. doi: [10.1177/87552930211011200](https://doi.org/10.1177/87552930211011200)

Minor modifications made to crustal and subduction models.
 Basin effects fully applied at periods above 1 sec:

Implementation of Crustal Earthquake GMMs:

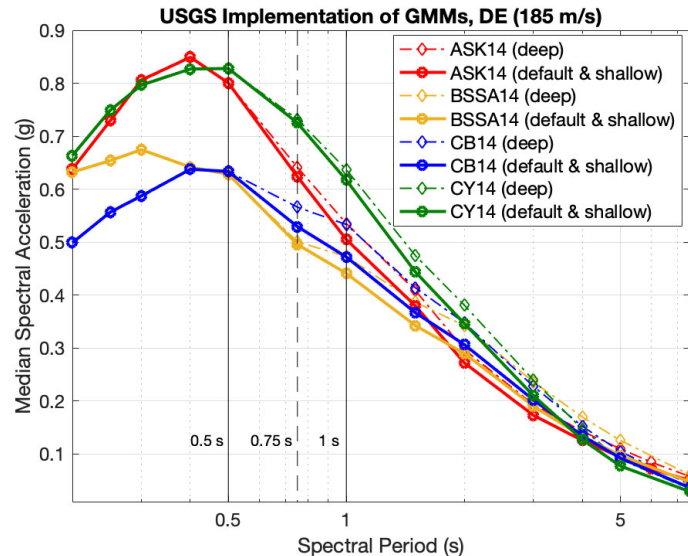

Modifications to Subduction Earthquake GMMs:

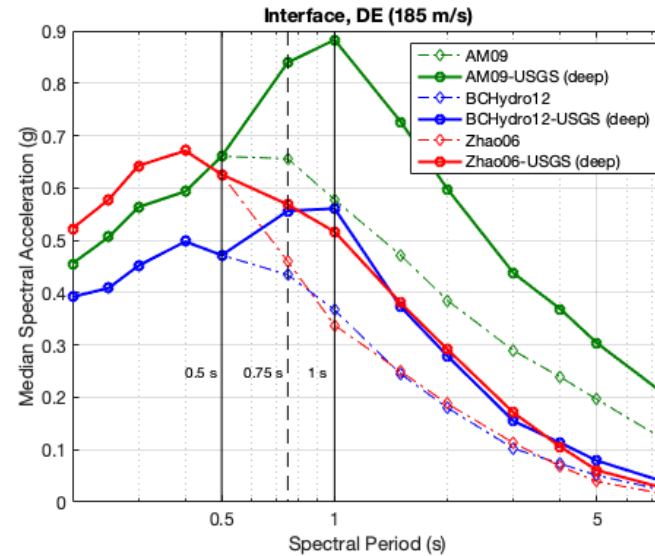

FEMA



Building Seismic Safety Council



Hazard Changes (WUS)

Ratio Maps (2018 local basin depth/2018 default basin depth):
2% in 50yr uniform hazard, 5 sec, Site Class D (260 m/s)

Disclaimer: This information is preliminary and is subject to revision. It is being provided to meet the need for timely best science. The information is provided on the condition that neither the U.S. Geological Survey nor the U.S. Government shall be held liable for any damages resulting from the authorized or unauthorized use of the information.

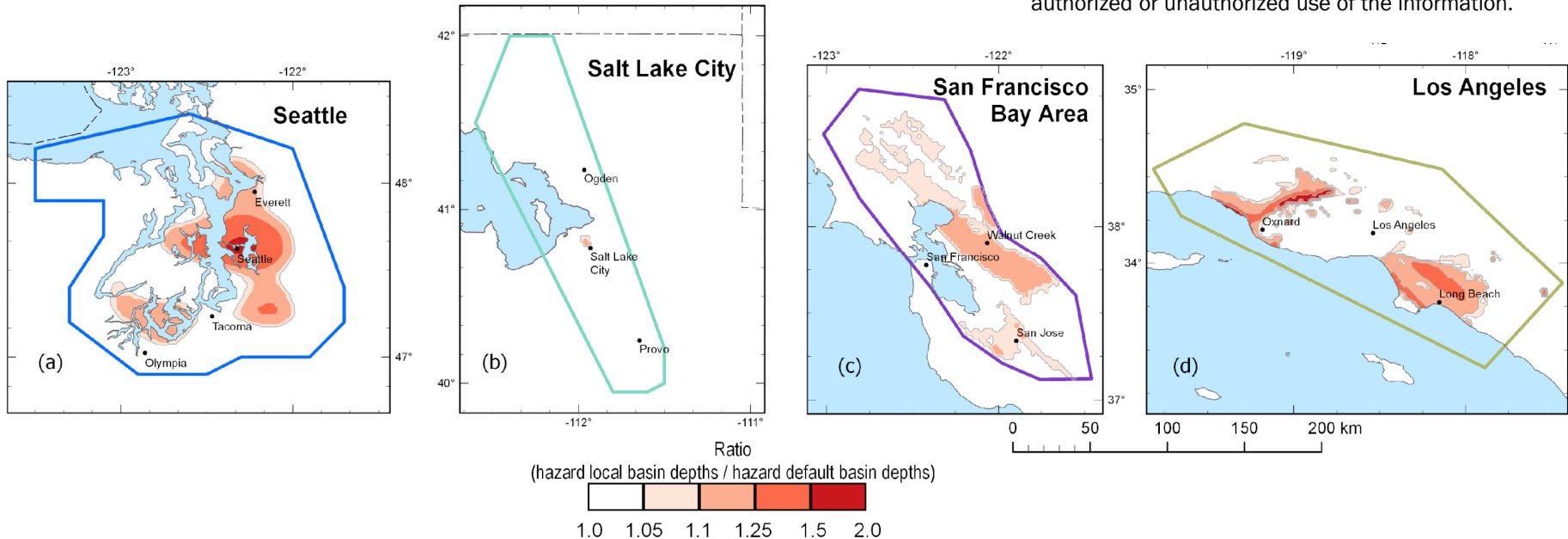

FEMA

Building Seismic Safety Council



USGS
science for a changing world

Outside of Conterminous US (OCONUS)



Procedures for Developing Multi-Period Response Spectra at Non-Conterminous United States Sites

FEMA P-2078 / June 2020



Developed Generic Spectral Shapes:

FEMA/ATC report, approved by BSSC PUC.

Shapes developed based on WUS data, function(S_S , S_S/S_1 , T_L)

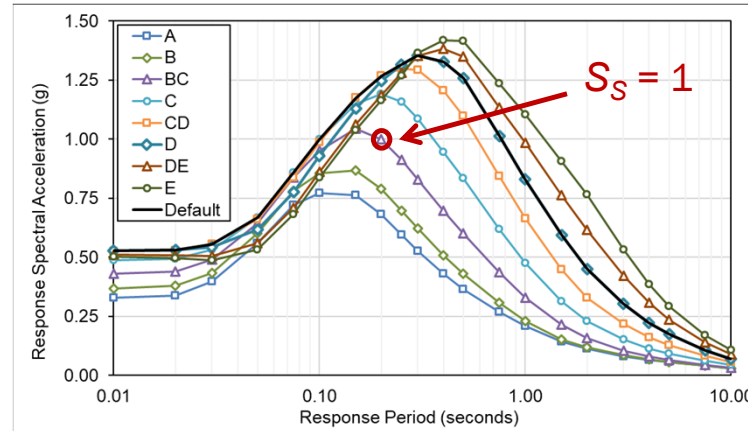

Figure B-17. Plots of probabilistic response spectrum shape parameters (RSSPs) by site class for Table B-17. GTL12S3R2.

Figure citation: Kircher C, Rezaeian S, Luco N – FEMA P-2078 (2020), Procedures for Developing Multi-Period Response Spectra of Non-Conterminous United States Sites, FEMA P-2078, prepared by ATC for FEMA, Washington, D.C.



FEMA

Building Seismic Safety Council



Outside of Conterminous US (OCONUS)

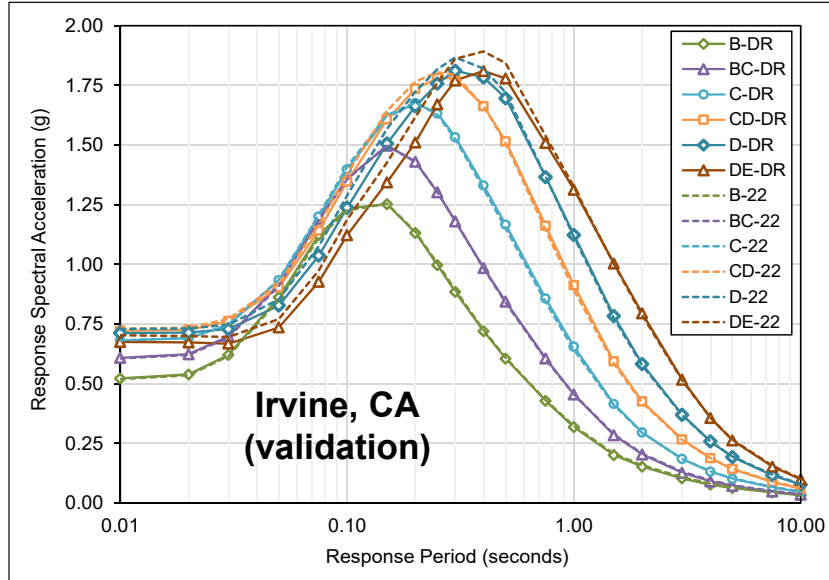

Solid Lines: Predicted values from S_s & S_1
 Dashed Lines: Exact values calculated for 2020 NEHRP

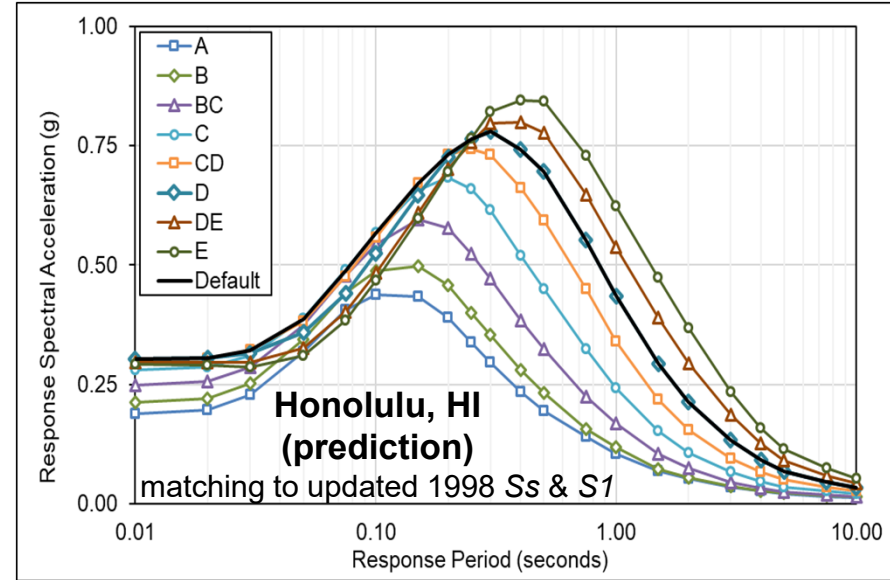

Figure citation: Kircher C, Rezaeian S, Luco N – FEMA P-2078 (2020), *Procedures for Developing Multi-Period Response Spectra of Non-Conterminous United States Sites*, FEMA P-2078, prepared by ATC for FEMA, Washington, D.C.



FEMA



Summary

- The Multi-Period-Response-Spectra requirement of the BSSC PUC influenced the 2018 update of USGS NSHM because GMMs needed to be applicable for 22 periods and 8 site classes
- The 2018 USGS NSHM updates included: (1) new GMMs in CEUS (14 updated seeds + 17 NGA-East + new site-effects model), (2) incorporation of deep basin effects in WUS, (3) removal of one crustal and one subduction GMM and minor modifications in WUS, and (4) update of seismicity catalog.

1. *Petersen et al. (Feb 2020), Earthquake Spectra (Overview)*

2. *Petersen et al. (2021), Earthquake Spectra (sensitivity analysis)*

3. *Shumway et al. (2021), Earthquake Spectra (data paper on added Ts and Vs30s)*

4. *Rezaeian et al. (2021), Earthquake Spectra (CEUS GMM details)*

5. *Powers et al. (2021), Earthquake Spectra (WUS GMM and basin effect details)*

- Generic spectral shapes used for OCONUS locations in 2020 *NEHRP Provisions* (FEMA P-2078 / ATC 136)



FEMA



Building Seismic
Safety Council



Questions



FEMA



Building Seismic
Safety Council



DISCLAIMER

- NOTICE: Any opinions, findings, conclusions, or recommendations expressed in this publication do not necessarily reflect the views of the Federal Emergency Management Agency. Additionally, neither FEMA, nor any of its employees make any warranty, expressed or implied, nor assume any legal liability or responsibility for the accuracy, completeness, or usefulness of any information, product or process included in this publication.
- The opinions expressed herein regarding the requirements of the *NEHRP Recommended Seismic Provisions*, the referenced standards, and the building codes are not to be used for design purposes. Rather the user should consult the jurisdiction's building official who has the authority to render interpretation of the code.
- This training material presentation is intended to remain complete in its entirety even if used by other presenters. While the training material could be tailored for use in other presentations, we caution users to account for issues of completeness and interpretation if only part of the material is used. We also strongly suggest users give proper credit/citation to this presentation and its author.



FEMA



Building Seismic
Safety Council



Chapter 3 (Section 3.2 - Part 2)

Dissection of Example Changes to the MCE_R Ground Motion Values

2020 NEHRP Provisions Training Materials
Nicolas Luco, Ph.D., U.S. Geological Survey



FEMA



Building Seismic
Safety Council

BSSC



 **USGS**
science for a changing world

Commentary to Chapter 22

- Modifications to MCE_R and MCE_G ground motions from Project '17 recommendations
- Modifications to MCE_R and MCE_G ground motions from 2018 USGS NSHM update
- Examples of changes in MCE_R and MCE_G values
- RISK-TARGETED MAXIMUM CONSIDERED EARTHQUAKE (MCE_R) SPECTRAL RESPONSE ACCELERATIONS
- MAXIMUM CONSIDERED EARTHQUAKE GEOMETRIC MEAN (MCE_G) PEAK GROUND ACCELERATIONS
- LONG-PERIOD TRANSITION MAPS
- USGS SEISMIC DESIGN GEODATABASE AND WEB SERVICE



FEMA



Building Seismic
Safety Council



USGS 2018 National Seismic Hazard Model (NSHM) Updates

Incorporation of ...

- 1) the NGA-East ground-motion models
- 2) deep sedimentary basin effects in the Los Angeles, Seattle, San Francisco, and Salt Lake City regions
- 3) earthquakes that occurred in 2013 through 2017
- 4) updated weighting of the western U.S. ground-motion models



FEMA



Building Seismic
Safety Council



BSSC Project '17 Recommendations

Modifications to ...

- 1) site-class effects
- 2) spectral periods that define the S_{MS} & S_{M1} ground-motion parameters
- 3) deterministic caps on the otherwise probabilistic ground motions
- 4) maximum-direction scale factors



FEMA



Building Seismic
Safety Council



Maximum-Direction Scale Factors

2015 NEHRP Provisions

Part 3, Resource Paper 4

RESOURCE PAPER 4 UPDATED MAXIMUM-RESPONSE SCALE FACTORS

RP4-1 UPDATED MAXIMUM-RESPONSE SCALE FACTORS

The proposed changes below update the “maximum-response scale factors” specified in the site-specific ground motion procedures (Chapter 21) of ASCE/SEI 7-10. These factors increase spectral response accelerations that represent the geometric mean (or a similar metric) of two horizontal ground motion components, such that they represent the maximum response in the horizontal plane. Recall that ASCE/SEI 7-10, via both Chapter 21 and the MCE_R ground motion maps, specifies maximum-response spectral response accelerations. Typical ground motion attenuation relations, including those applied by the USGS in preparing the MCE_R ground motion maps, provide geometric-mean spectral response accelerations.



FEMA



Building Seismic
Safety Council



Maximum-Direction Scale Factors

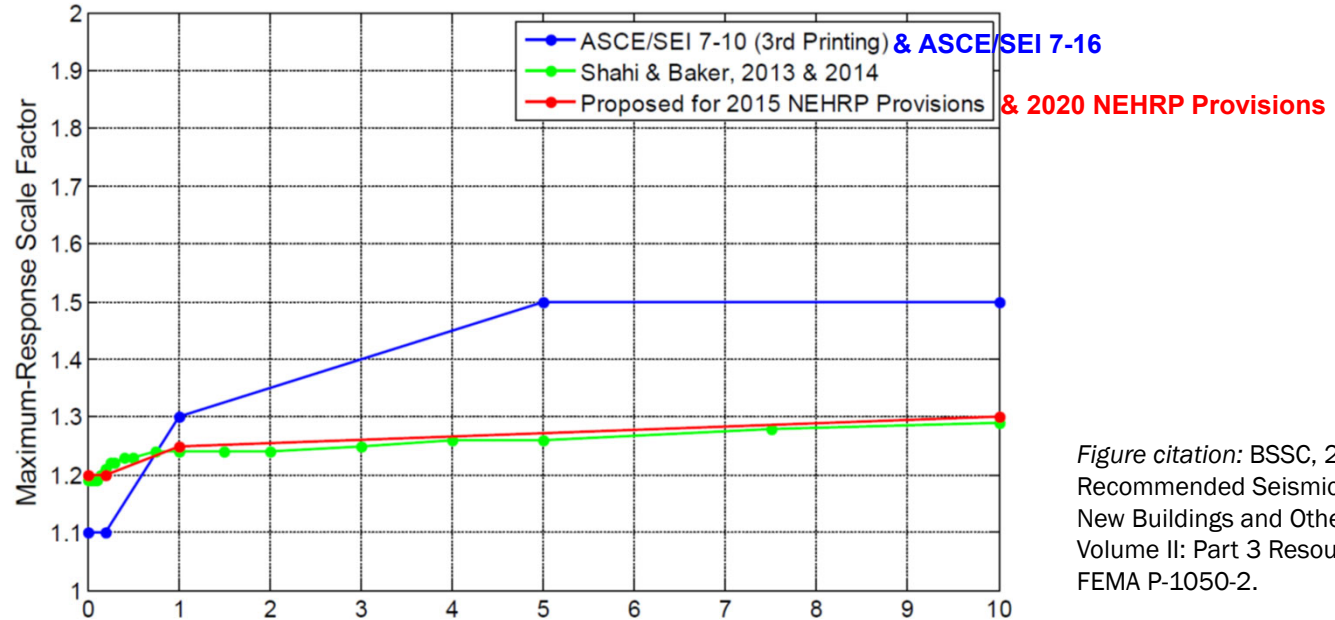

Figure citation: BSSC, 2015. NEHRP Recommended Seismic Provisions for New Buildings and Other Structures, Volume II: Part 3 Resource Papers. FEMA P-1050-2.



FEMA

Building Seismic Safety Council



Deterministic Caps

21.2.2 Deterministic (MCE_R) Ground Motions

The deterministic spectral response acceleration at each period shall be calculated as an 84th-percentile 5% damped spectral response acceleration in the direction of maximum horizontal response computed at that period. The largest such acceleration calculated for scenario earthquakes on all known faults within the region shall be used. The scenario earthquakes shall be determined from deaggregation for the probabilistic spectral response acceleration at each period. Scenario earthquakes contributing less than 10% of the largest contributor at each period shall be ignored.



FEMA



Building Seismic
Safety Council



Deterministic Caps

Table C21.2.2-1 Examples of scenario earthquake from hazard deaggregations at a site in San Jose, California

Period <i>T</i> (s)	Scenario Earthquake							
	Hayward		Calaveras		San Andreas		Silver Creek	
	<i>M</i>	Contribution	<i>M</i>	Contribution	<i>M</i>	Contribution	<i>M</i>	Contribution
0.20	7.0	53%	7.2	16%	7.9	11%	6.9	3%
0.25	7.0	52%	7.2	16%	7.9	12%	6.9	3%
0.30	7.0	52%	7.2	16%	7.9	13%	6.9	3%
0.40	7.0	52%	7.2	16%	7.9	15%	7.0	3%
0.50	7.0	51%	7.3	16%	7.9	16%	7.0	3%
0.75	7.1	49%	7.3	16%	7.9	19%	7.0	3%
1.0	7.1	48%	7.3	16%	7.9	20%	7.1	2%



FEMA

Building Seismic Safety Council



Commentary to Chapter 22

- Modifications to MCE_R and MCE_G ground motions from Project '17 recommendations
- Modifications to MCE_R and MCE_G ground motions from 2018 USGS NSHM update
- Examples of changes in MCE_R and MCE_G values
- RISK-TARGETED MAXIMUM CONSIDERED EARTHQUAKE (MCE_R) SPECTRAL RESPONSE ACCELERATIONS
- MAXIMUM CONSIDERED EARTHQUAKE GEOMETRIC MEAN (MCE_G) PEAK GROUND ACCELERATIONS
- LONG-PERIOD TRANSITION MAPS
- USGS SEISMIC DESIGN GEODATABASE AND WEB SERVICE



FEMA



Building Seismic
Safety Council



Examples of Changes in MCE_R Values

2009 NEHRP Recommended Seismic Provisions

Table C11.4-1 Thirty-Four Cities, Site Locations (Latitude and Longitude), and Associated Counties and Populations At Risk for Which Values of Ground Motions Are Provided

Region	City and Location of Site			County or Metropolitan Statistical Area		
	Name	Latitude	Longitude	Name	Population	
Southern California	Los Angeles	34.05	-118.25	Los Angeles	9,948,081	
	Century City	34.05	-118.40			
	Northridge	34.20	-118.55			
	Long Beach	33.80	-118.20			
	Irvine	33.65	-117.80	Orange	3,002,048	
	Riverside	33.95	-117.40	Riverside	2,026,803	
	San Bernardino	34.10	-117.30	San Bernardino	1,999,332	
	San Luis Obispo	35.30	-120.65	San Luis Obispo	257,005	
	San Diego	32.70	-117.15	San Diego	2,941,454	
	Santa Barbara	34.45	-119.70	Santa Barbara	400,335	
	Ventura	34.30	-119.30	Ventura	799,720	
	Total Population - S. California			22,349,098	Population - 8 Counties	21,374,778

Northern California	Oakland	37.80	-122.25
	Concord	37.95	-122.00
	Monterey	36.60	-121.90
	Sacramento	38.60	-121.50
	San Francisco	37.75	-122.40
	San Mateo	37.55	-122.30
	San Jose	37.35	-121.90
	Santa Cruz	36.95	-122.05
	Vallejo	38.10	-122.25
Santa Rosa	38.45	-122.70	
Total Population - N. California		14,108,451	
Pacific Northwest	Seattle	47.60	-122.30
	Tacoma	47.25	-122.45
	Everett	48.00	-122.20
	Portland	45.50	-122.65
	Total Population - OR and WA		10,096,556
Other WUS	Salt Lake City	40.75	-111.90
	Boise	43.60	-116.20
	Reno	39.55	-119.80
	Las Vegas	36.20	-115.15
	Total Population - ID/UT/NV		6,512,057
CEUS	St. Louis	38.60	-90.20
	Memphis	35.15	-90.05
	Charleston	32.80	-79.95
	Chicago	41.85	-87.65
	New York	40.75	-74.00
Total Population - MO/TN/SC/IL/NY		48,340,918	



FEMA



Building Seismic Safety Council



Examples of Changes in MCE_R Values

2020 NEHRP Provisions

Table C22-3 Comparison of short-period MCE_R spectral response acceleration values from these Provisions, ASCE/SEI 7-16, and ASCE/SEI 7-10. The S_{MS} values are for the default site class.

Location Name	ASCE/SEI 7-10		ASCE/SEI 7-16		2020 Provisions	
	S_S (g)	S_{MS} (g)	S_S (g)	S_{MS} (g)	S_S (g)	S_{MS} (g)
Los Angeles, CA	2.40	2.40	1.97	2.36	2.25	2.37
Century City, CA	2.17	2.17	2.11	2.53	2.37	2.49
Northridge, CA	1.69	1.69	1.74	2.08	2.09	2.26
Long Beach, CA	1.64	1.64	1.68	2.02	1.90	2.03
Irvine, CA	1.55	1.55	1.25	1.50	1.43	1.68
Riverside, CA	1.50	1.50	1.50	1.80	1.50	1.67
San Bernardino, CA	2.37	2.37	2.33	2.79	2.78	2.97
San Luis Obispo, CA	1.12	1.18	1.09	1.31	1.23	1.45
San Diego, CA	1.25	1.25	1.58	1.89	1.74	1.80
Santa Barbara, CA	2.83	2.83	2.12	2.54	2.37	2.44
Ventura, CA	2.38	2.38	2.02	2.42	2.25	2.38



FEMA

Building Seismic Safety Council



Examples of Changes in MCE_R Values

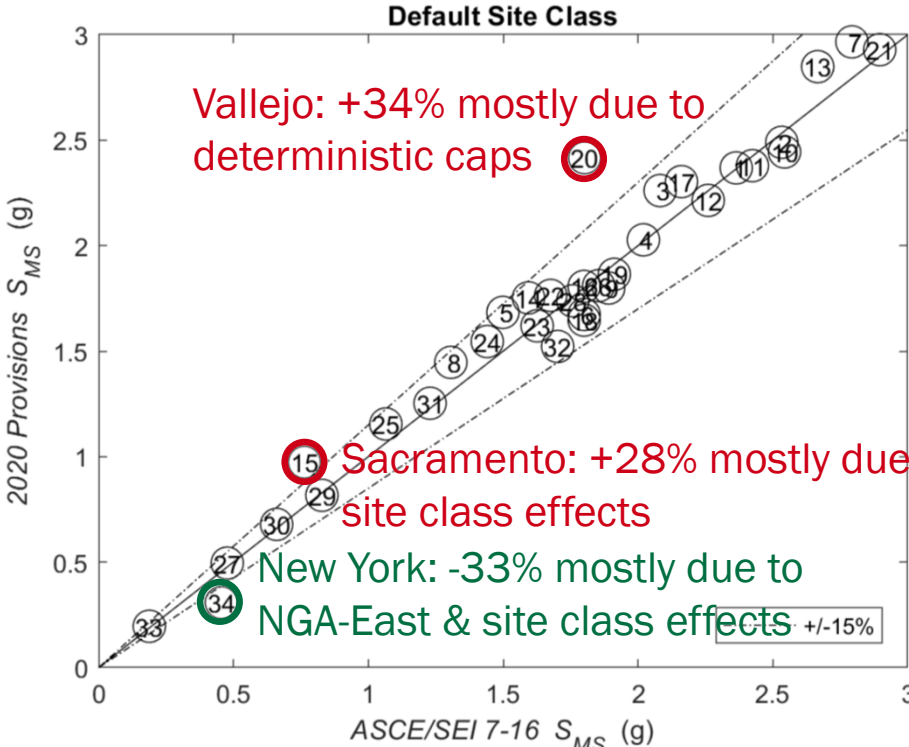
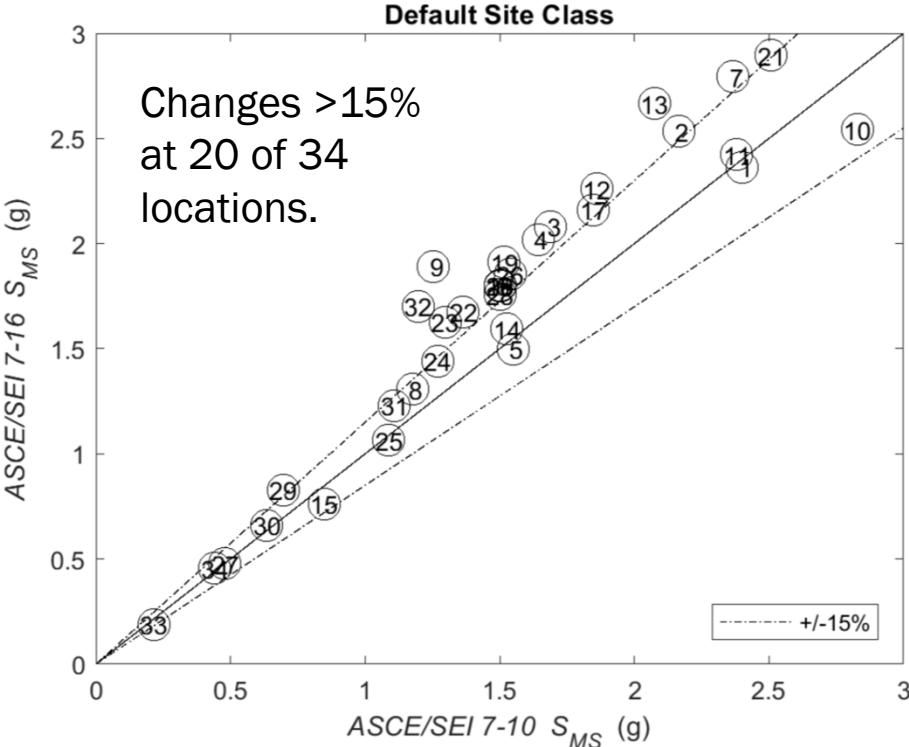

FEMA



Building Seismic
Safety Council



Examples of Changes in MCE_R Values

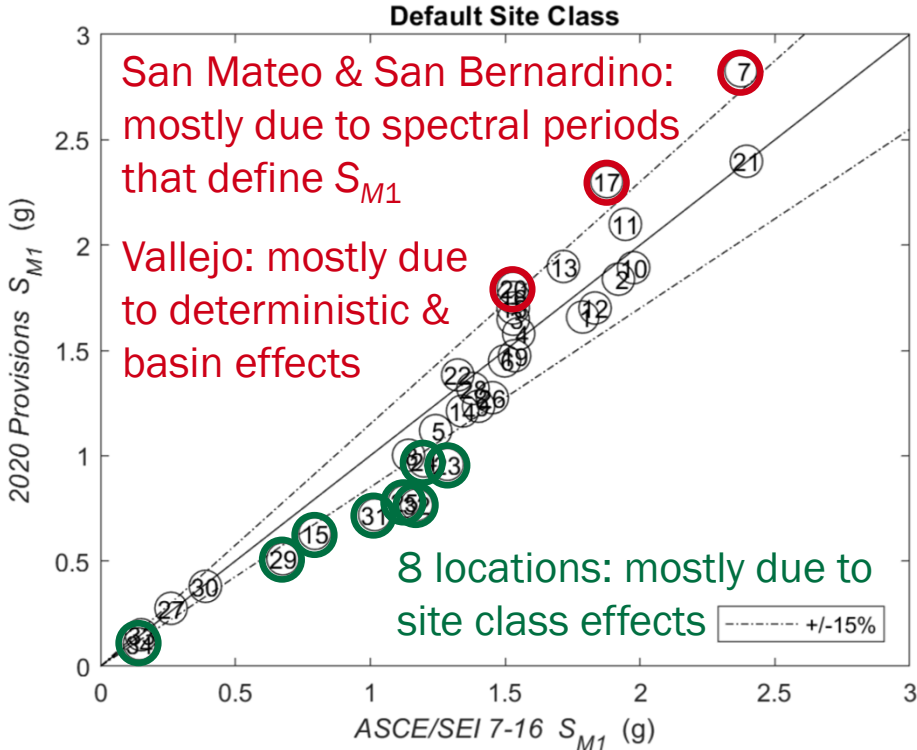
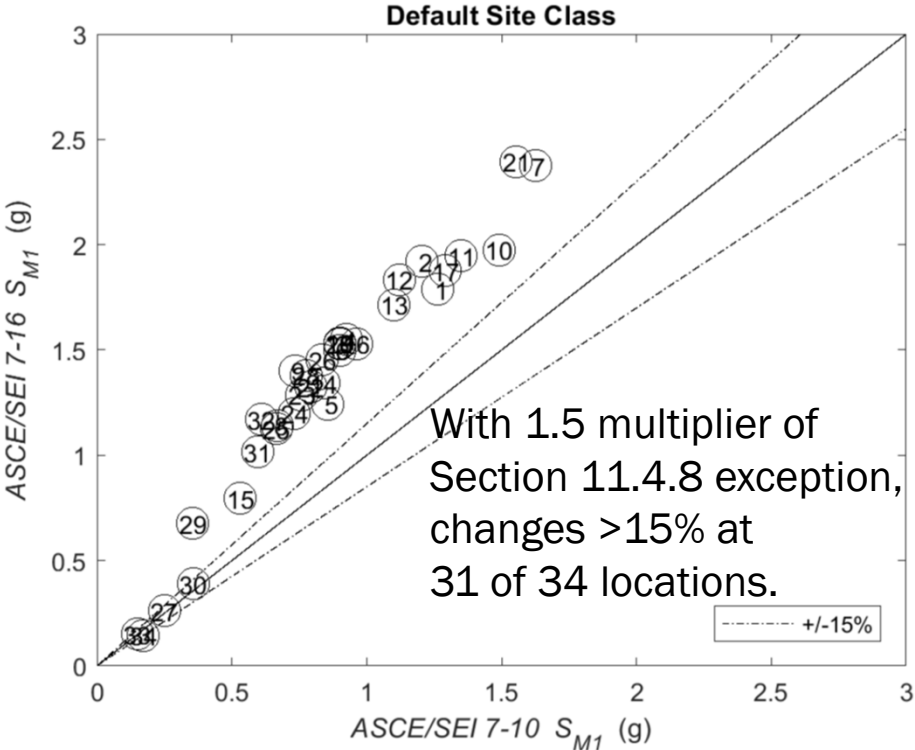

FEMA

Building Seismic Safety Council



Examples of Changes in SDC

2020 NEHRP Provisions

Table C22-6 Comparison of seismic design categories from these *Provisions*, *ASCE/SEI 7-16*, and *ASCE/SEI 7-10*, for the default site class and risk categories I, II, or III. The “SDCs” categories are determined from Table 11.6-1 (“Seismic Design Category Based on Short-Period Response Acceleration Parameter”) alone, but only where $S_I < 0.75g$.

Location Name	ASCE/SEI 7-10		ASCE/SEI 7-16		2020 Provisions	
	"SDC _s "	SDC	"SDC _s "	SDC	"SDC _s "	SDC
Los Angeles, CA	N/A	E	D	D	D	D
Century City, CA	N/A	E	N/A	E	N/A	E
			D	D	D	D
			D	D	N/A	E
			D	D	D	D
			D	D	D	D
			N/A	N/A	N/A	N/A
			D	D	D	D
San Diego, CA	D	D	D	D	D	D
Santa Barbara, CA	N/A	E	N/A	E	N/A	E
Ventura, CA	N/A	E	N/A	E	N/A	E

From ASCE 7-10 to ASCE 7-16, SDC decreases at 2 of 34 locations, from E to D.

From ASCE 7-16 to 2020 Provisions, SDC increases at 4 of 34 locations, from D to E, mostly due to deterministic capping and basin effects.



FEMA



Building Seismic Safety Council



Examples of Changes in SDC

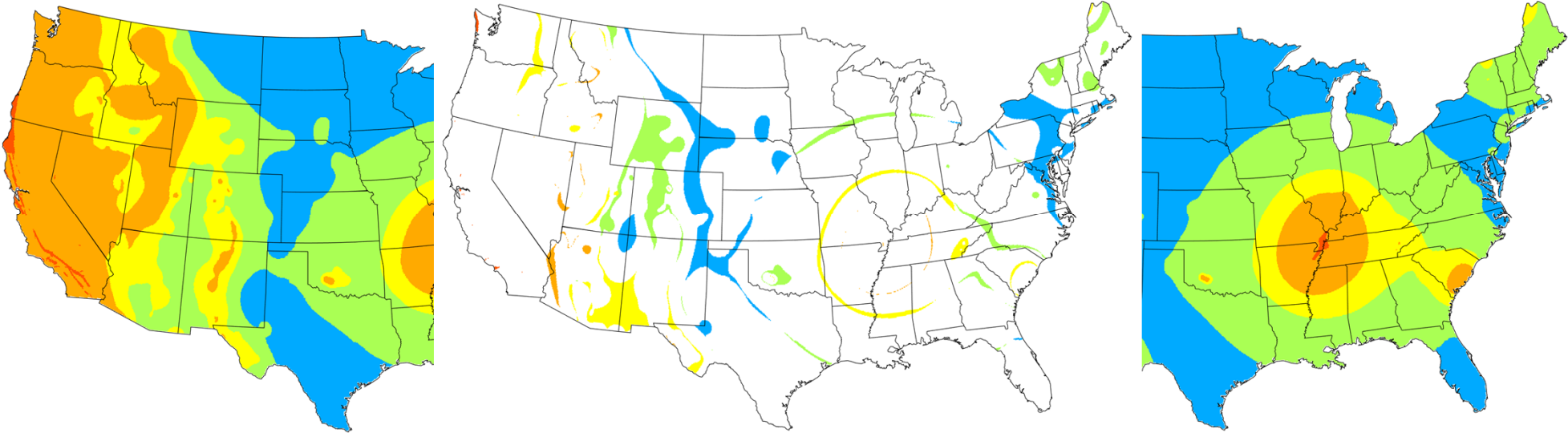

Disclaimer: This information is preliminary and is subject to revision. It is being provided to meet the need for timely best science. The information is provided on the condition that neither the U.S. Geological Survey nor the U.S. Government shall be held liable for any damages resulting from the authorized or unauthorized use of the information.



FEMA

Building Seismic Safety Council



USGS
science for a changing world

Summary of Changes in MCE_R Values

For default site conditions ...

- S_{MS} changes by less than 15% at 31 of the 34 locations;
- S_{M1} changes by less than 15% at 23 of the 34 locations;
- SDC changes at 4 of the 34 locations, from SDC D to E;
- Most of these changes are due to the Project '17 modifications to site-class effects or deterministic caps, but some are caused by the other Project '17 and 2018 NSHM updates, particularly the 2018 NSHM incorporation of basin effects.

Changes for other site classes at other locations can be probed using the *USGS Seismic Design Web Services* and *BSSC Tool for Seismic Design Map Values*.



FEMA



Building Seismic
Safety Council



Commentary to Chapter 22

- Modifications to MCE_R and MCE_G ground motions from Project '17 recommendations
- Modifications to MCE_R and MCE_G ground motions from 2018 USGS NSHM update
- Examples of changes in MCE_R and MCE_G values
- RISK-TARGETED MAXIMUM CONSIDERED EARTHQUAKE (MCE_R) SPECTRAL RESPONSE ACCELERATIONS
- MAXIMUM CONSIDERED EARTHQUAKE GEOMETRIC MEAN (MCE_G) PEAK GROUND ACCELERATIONS
- LONG-PERIOD TRANSITION MAPS
- USGS SEISMIC DESIGN GEODATABASE AND WEB SERVICE



FEMA



Building Seismic
Safety Council



USGS Seismic Design Geodatabase

The screenshot shows a web browser window with the following elements:

- Browser Tab:** Gridded earthquake ground mot x
- Address Bar:** <https://www.sciencebase.gov/catalog/item/5c869110e4b09388244b3d48>
- USGS Logo:** science for a changing world
- Navigation Bar:** ScienceBase-Catalog, Communities, More ▾, Help ▾
- Breadcrumbs:** ScienceBase Catalog → Geologic Hazards Sci... → Engineering & Risk Pr... → U.S. Seismic Design ... → Based on 2018 Nation... → Gridded earthquake gr...
- Item Title:** Gridded earthquake ground motions for the 2020 NEHRP Recommended Seismic Provisions and 2022 ASCE/SEI 7 Standard
- Action Buttons:** Add ▾, View ▾, Manage Item ▾



FEMA

Building Seismic Safety Council



USGS Seismic Design Geodatabase

1.1 : Conterminous United States

Contributor: Peter M. Parsons, Alison M. Conway

Add View Manage Item

Attached Files

Click on title to download individual files attached to this item or [download](#) all files listed below as a compressed file.

ConUS-2020NEHRP_2022ASCE7_MCER.xml <i>Original FGDC Metadata</i>	View	2020-05-11 09:20	14.91 KB	rukstales@usgs.gov
ConUS-2018_MaxDirection-RTSAs_vs30=1500-siteClass=A_NEHRP-2020.csv "Site Class A, Risk-Targeted Spectral Accelerations"		2020-03-17 22:39	169 MB	nluco@usgs.gov
ConUS-2018_MaxDirection-84thSAs_vs30=1500-siteClass=A_NEHRP-2020.csv "Site Class A, 84th-percentile Spectral Accelerations"		2020-03-17 22:22	65.07 MB	nluco@usgs.gov
ConUS-2018_MaxDirection-RTSAs_vs30=1080-siteClass=B_NEHRP-2020.csv "Site Class B, Risk-Targeted Spectral Accelerations"		2020-03-17 22:38	168.84 MB	nluco@usgs.gov



FEMA

Building Seismic Safety Council



USGS Seismic Design Web Service

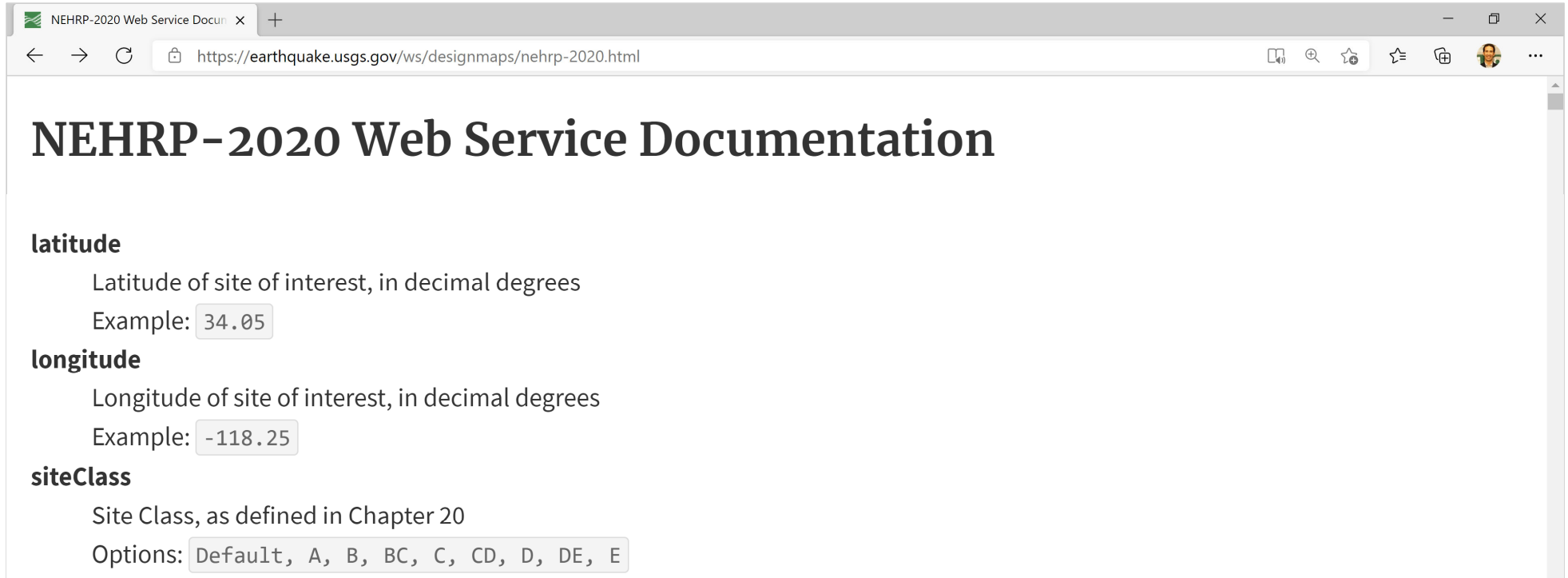

The screenshot shows a web browser window with the following content:

- Browser tab: NEHRP-2020 Web Service Docum x
- Address bar: <https://earthquake.usgs.gov/ws/designmaps/nehrrp-2020.html>
- Page title: NEHRP-2020 Web Service Documentation
- Section: **latitude**
Latitude of site of interest, in decimal degrees
Example:
- Section: **longitude**
Longitude of site of interest, in decimal degrees
Example:
- Section: **siteClass**
Site Class, as defined in Chapter 20
Options:



FEMA



Building Seismic
Safety Council



USGS Seismic Design Web Service

```
https://earthquake.usgs.gov/ws/...
https://earthquake.usgs.gov/ws/designmaps/nehrl-2020.json?latitude=34&longitude=-118&riskCategory=III&siteClass=C&title=Example

"response": {
  "data": {
    "pgam": 0.9,
    "sms": 2.19,
    "sm1": 1.05,
    "sds": 1.46,
    "sd1": 0.7,
    "sdc": "D",
    "ss": 2.15,
    "s1": 0.75,
    "ts": 0.479,
    "t0": 0.0958,
    "t1": 8,
    "cv": null,
    "multiPeriodDesignSpectrum": {
      "periods": [
        0,
        0.01,
        0.02,
        0.03,
        0.05,
        0.075.
```



FEMA

Building Seismic Safety Council



BSSC Tool for Seismic Design Map Values

The screenshot shows a web browser window with the URL <https://www.wbdg.org/additional-resources/tools/bssc2020nehrp>. The page header features the WBDG logo (Whole Building Design Guide) and navigation links for 'CREATE ACCOUNT', 'LOG IN', and 'SEARCH'. A dark blue navigation bar contains the following menu items: 'DESIGN RECOMMENDATIONS', 'PROJECT MANAGEMENT - O & M', 'FEDERAL FACILITY CRITERIA', 'CONTINUING EDUCATION', and 'ADDITIONAL RESOURCES'. The breadcrumb trail reads: 'ADDITIONAL RESOURCES / TOOLS / BSSC TOOL FOR 2020 NEHRP PROVISIONS SEISMIC DESIGN MAP VALUES'. The main heading is 'BSSC Tool For 2020 NEHRP Provisions Seismic Design Map Values', with the version noted as 'Version: Beta'.



FEMA



BSSC Tool for Seismic Design Map Values

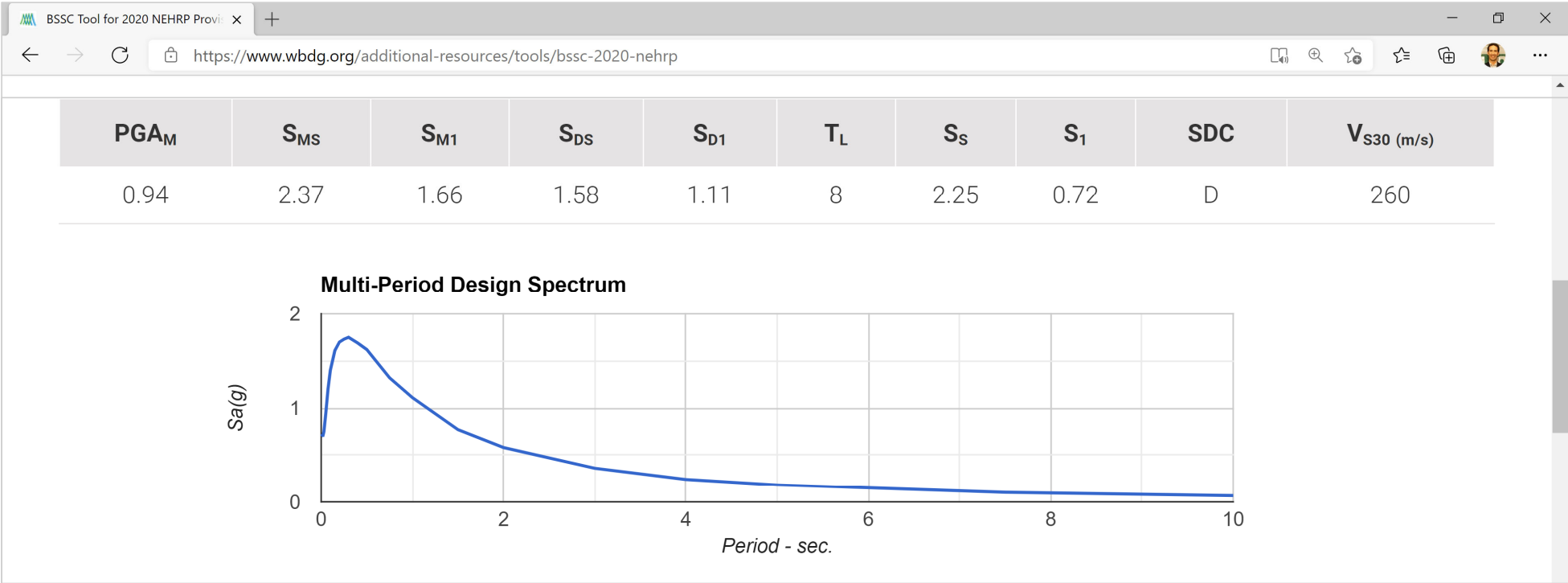

<https://doi.org/10.5066/F7NK3C76>



USGS Earthquake Hazards

2020 NEHRP Provisions (NEHRP-2020)

Web Interface: [BSSC Tool for 2020 NEHRP Provisions Seismic Design Maps Values](#)

Web Service (source of data for Web Interface): ["USGS Seismic Design Web Service"](#) for NEHRP-2020

Maps (in document): See 2020 NEHRP Recommended Seismic Provisions for New Buildings and Other Structures

Maps (online only): USGS Online-only maps referenced by the 2020 NEHRP Recommended Seismic Provisions and 2022 ASCE/SEI 7 Standard ([preview one example](#))

Data: ["USGS Seismic Design Geodatabase"](#) for NEHRP-2020 (*currently requires [sign up](#)*)



FEMA

Building Seismic
Safety Council



Questions



FEMA



Building Seismic
Safety Council



DISCLAIMER

- NOTICE: Any opinions, findings, conclusions, or recommendations expressed in this publication do not necessarily reflect the views of the Federal Emergency Management Agency. Additionally, neither FEMA, nor any of its employees make any warranty, expressed or implied, nor assume any legal liability or responsibility for the accuracy, completeness, or usefulness of any information, product or process included in this publication.
- The opinions expressed herein regarding the requirements of the *NEHRP Recommended Seismic Provisions*, the referenced standards, and the building codes are not to be used for design purposes. Rather the user should consult the jurisdiction's building official who has the authority to render interpretation of the code.
- This training material presentation is intended to remain complete in its entirety even if used by other presenters. While the training material could be tailored for use in other presentations, we caution users to account for issues of completeness and interpretation if only part of the material is used. We also strongly suggest users give proper credit/citation to this presentation and its author.



FEMA



Building Seismic
Safety Council



Chapter 3 (Section 3.3) New Multi-Period Response Spectra and Ground Motion Requirements

2020 NEHRP Provisions Training Materials

Charles A. Kircher, Ph.D., P.E., NAE, Kircher & Associates



FEMA



Building Seismic
Safety Council

BSSC



Design (As Usual) Using New MPRS

- Design Procedures
 - ELF procedures (Chapter 12) are not affected by proposed changes (although values of design parameters, S_{DS} and S_{D1} , would better match the underlying response spectrum of the site of interest)
 - MRSA procedures (Chapter 12) are not affected by proposed changes (although multi-period design spectra would provide a more reliable calculation of dynamic response)
- Design Ground Motions
 - Ground motion parameters (and MPRS) are available online from a USGS web service [<https://doi.org/10.5066/F7NK3C76>] for user specified site location (i.e., latitude and longitude) and site conditions (i.e., site class)
 - Site-specific ground motion procedures (Chapter 21) now permit use of MPRS obtained online from the USGS web service (in lieu of a hazard analysis)



FEMA



Building Seismic
Safety Council



New Multi-Period Response Spectra (MPRS)

- Collectively improve the accuracy of the frequency content of earthquake design ground motions
- Enhance the reliability of the seismic design parameters derived from these ground motions
- Make better use of the available earth science (including the 2018 update of the USGS NSHM) which has, in general, sufficiently advanced to accurately define spectral response for different site conditions over a broad range of periods
- Eliminate the need for site-specific hazard analysis required by ASCE/SEI 7-16 (2015 *NEHRP Provisions*) for certain (soft soil) sites where the site coefficients are either undefined or inadequate
- Do no change the ELF (MRSA) design procedures commonly used by most design engineers and projects



FEMA



Building Seismic
Safety Council



Summary of MPRS and Related Changes (to ASCE/SEI 7-16)

- Chapter 11 – Seismic Ground Motion Values
 - Added new “site-specific” multi-period design spectra and related values of seismic design parameters (e.g., S_{MS} , S_{M1} and PGA_M) of the “USGS Seismic Design Geodatabase”, available online from a USGS web service for user-defined site location and site conditions (i.e., site class)
 - Deleted site coefficient tables (i.e., site factors are no longer required)
 - Removed the site-specific (interim solution) ground motion procedures of ASCE/SEI 7-16
- Chapter 20 – Site Classification Procedure for Seismic Design
 - Added three new site classes (Site Classes BC, CD and DE) to Table 20.3-1
 - *Added new site class shear wave velocity-based requirements*



FEMA



Building Seismic
Safety Council



Summary of MPRS and Related Changes (to ASCE/SEI 7-16)

- Chapter 21 – Site-specific Ground Motion Procedures for Seismic Design
 - Added new deterministic MCE_R “scenario” earthquake requirements (based on de-aggregation)
 - Revised determination of S_{D1} from site-specific design spectrum (Section 21.4)
- Chapter 22 – Seismic Ground Motion and Long-Period Period Maps
 - Incorporated USGS update of MCE_R ground motions based on 2018 update of the USGS NSHM
 - Updated to provide new maps of S_{MS} and S_{M1} (and PGA_M) for “default” site conditions



FEMA



Building Seismic
Safety Council



Two-Period Design Response Spectrum (Multi-Period Design Spectrum)

(Figure 11.4-1, ASCE/SEI 7-05, ASCE/SEI 7-10 and ASCE/SEI 7-16 with annotation)

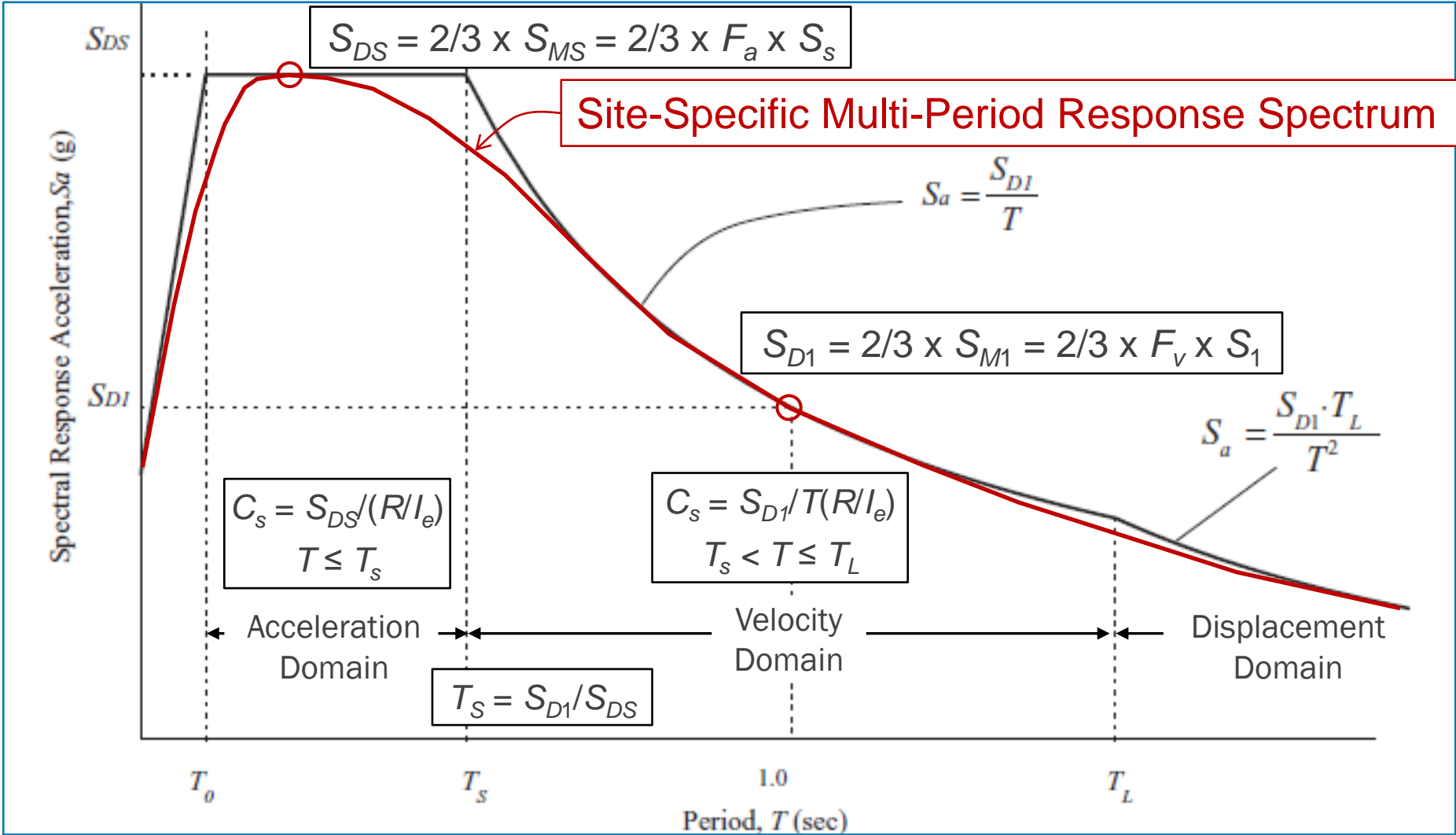

FEMA



Building Seismic Safety Council



The “Problem” with ASCE/SEI 7-10

- For softer sites, in particular those where seismic hazard is governed by large magnitude earthquakes:
 - Frequency content of ground motions (spectrum shape) is not accurately characterized by of the two-period design response spectrum and site coefficients
 - Design ground motions are significantly underestimated (e.g., by as much as a factor of 2 at longer response periods)



FEMA



Building Seismic
Safety Council



Comparison of ASCE/SEI 7-16 Two-Period (ELF) Design Spectrum w/o Spectrum Shape Adjustment and Multi-Period Response Spectra based on M7.0 earthquake ground motions at $R_x = 6.8$ km) – Site Class C

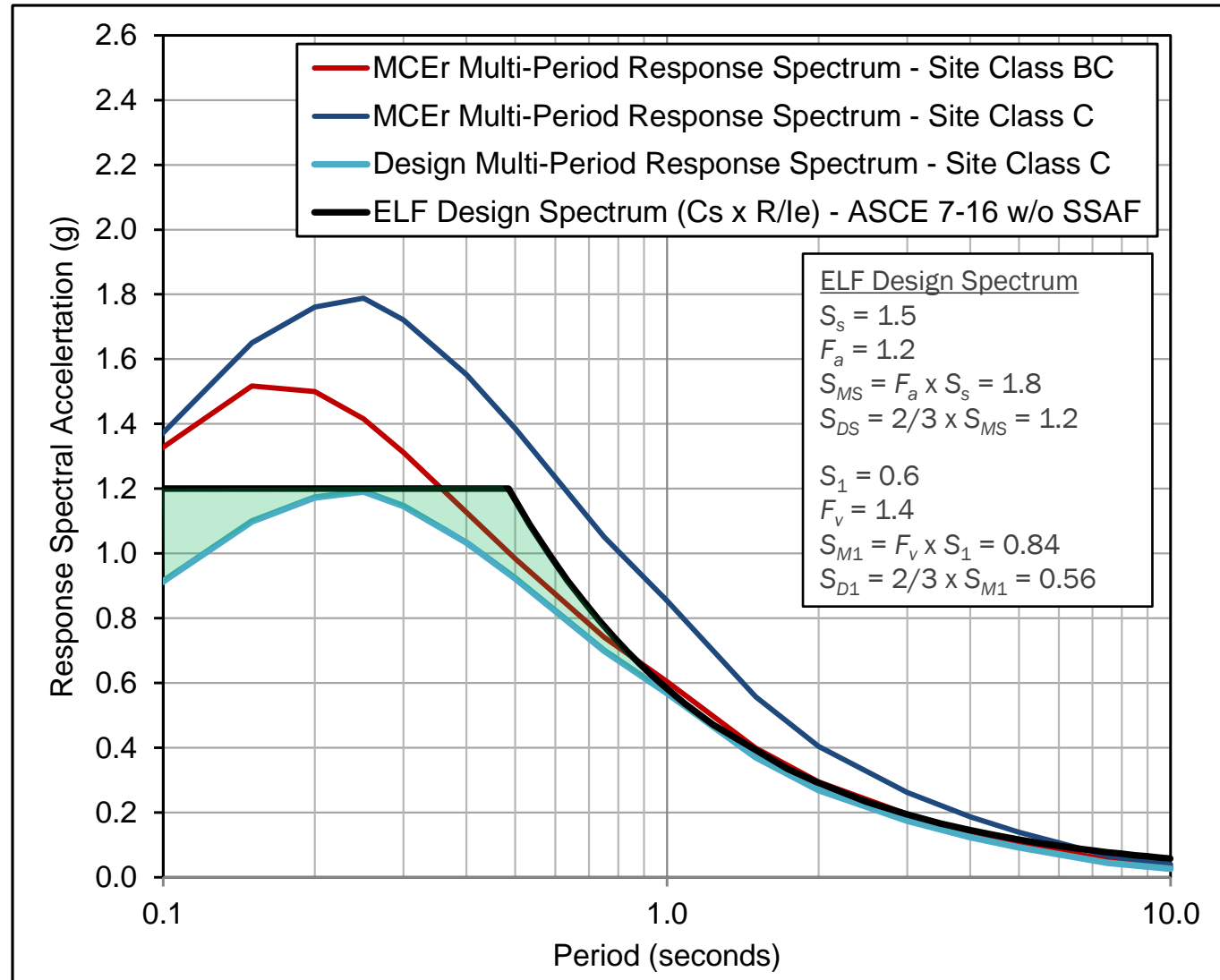

FEMA



Building Seismic Safety Council



Comparison of ASCE/SEI 7-16 Two-Period (ELF) Design Spectrum w/o Spectrum Shape Adjustment and Multi-Period Response Spectra based on M7.0 earthquake ground motions at $R_x = 6.8$ km) – Site Class D

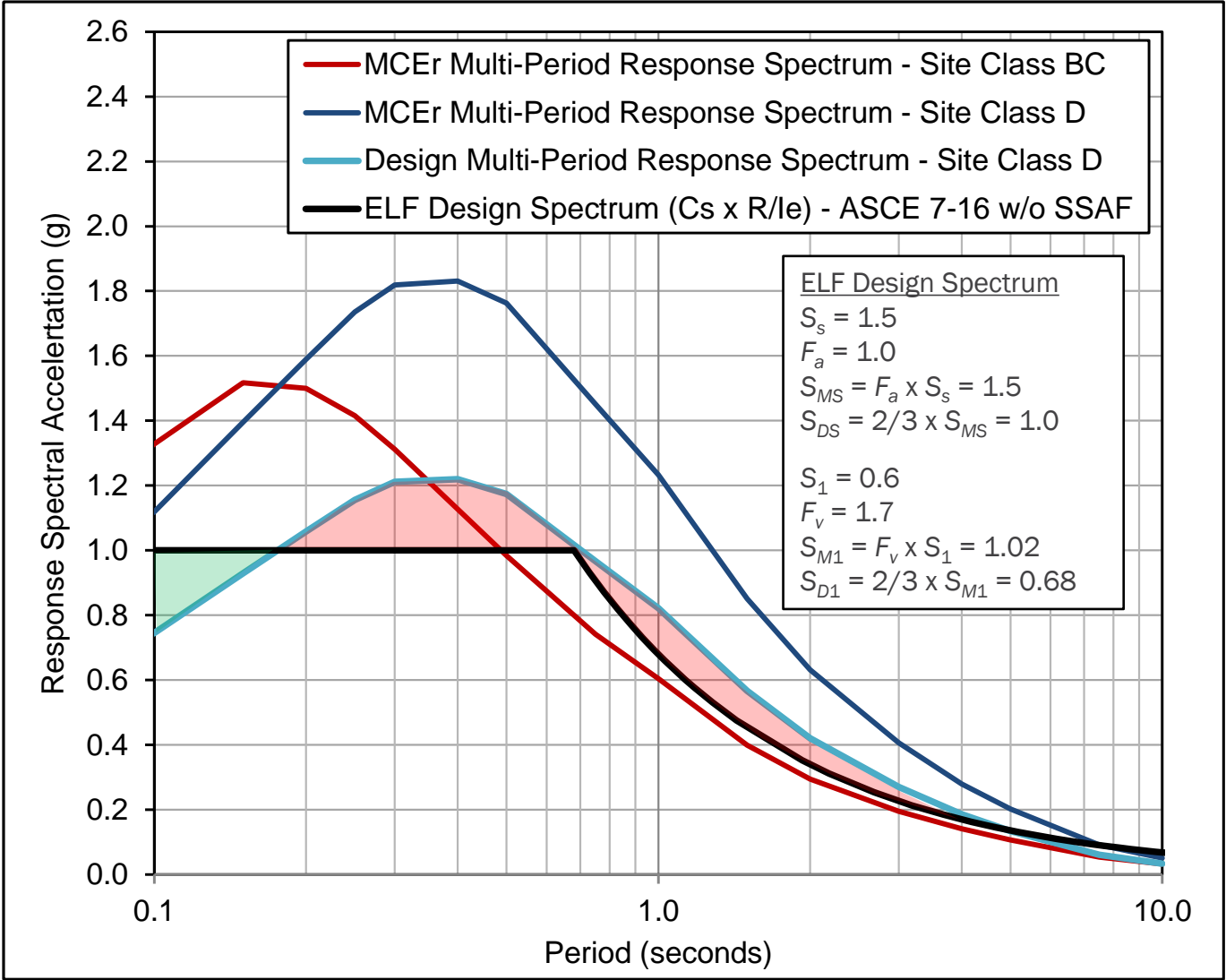

FEMA



Building Seismic Safety Council



Comparison of ASCE/SEI 7-16 Two-Period (ELF) Design Spectrum w/o Spectrum Shape Adjustment and Multi-Period Response Spectra based on M7.0 earthquake ground motions at $R_x = 6.8$ km) – Site Class E

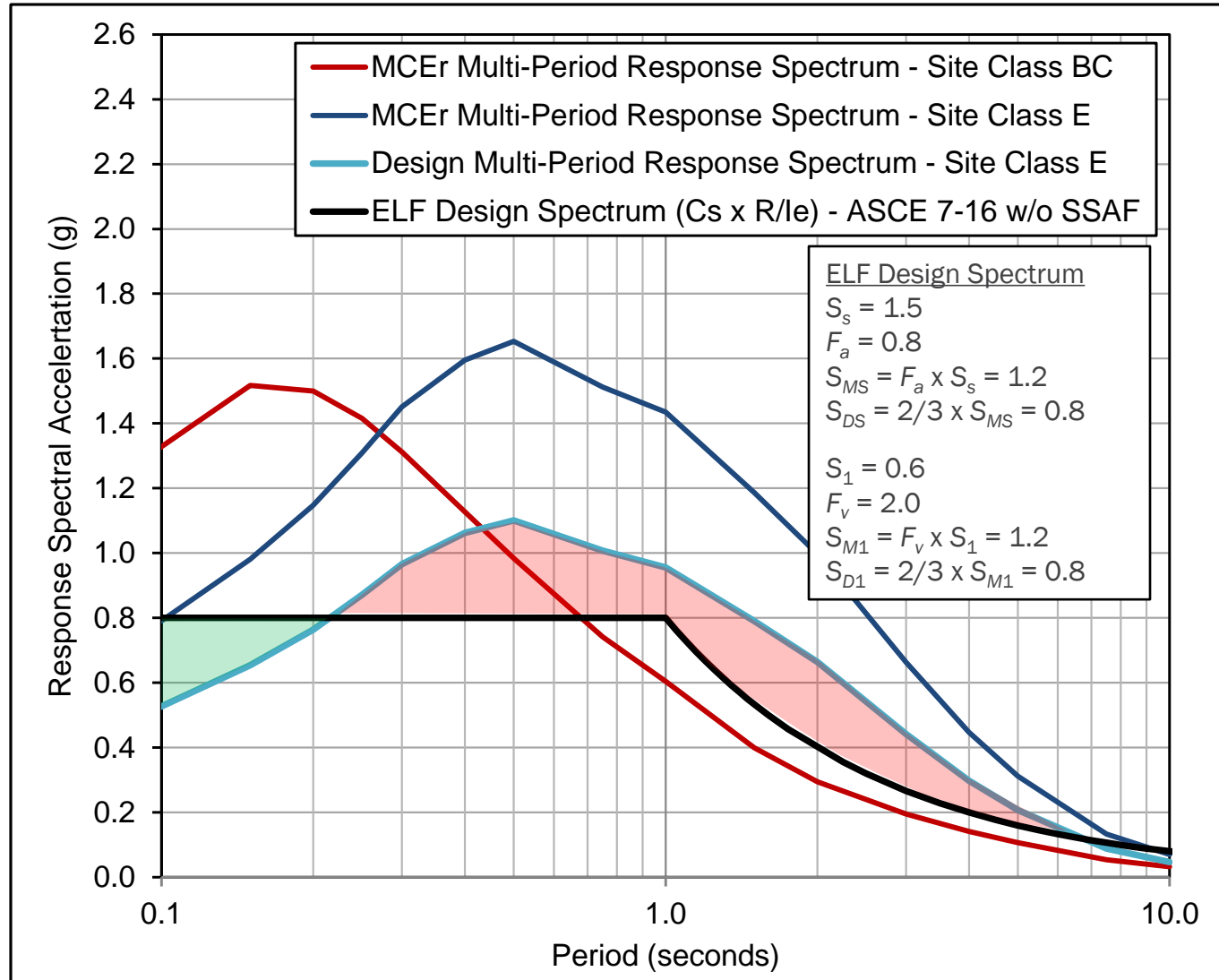

FEMA



Building Seismic Safety Council



Comparison of ASCE/SEI 7-16 Two-Period (ELF) Design Spectrum w/o Spectrum Shape Adjustment and Multi-Period Response Spectra based on M8.0 earthquake ground motions at $R_x = 9.9$ km) – Site Class E

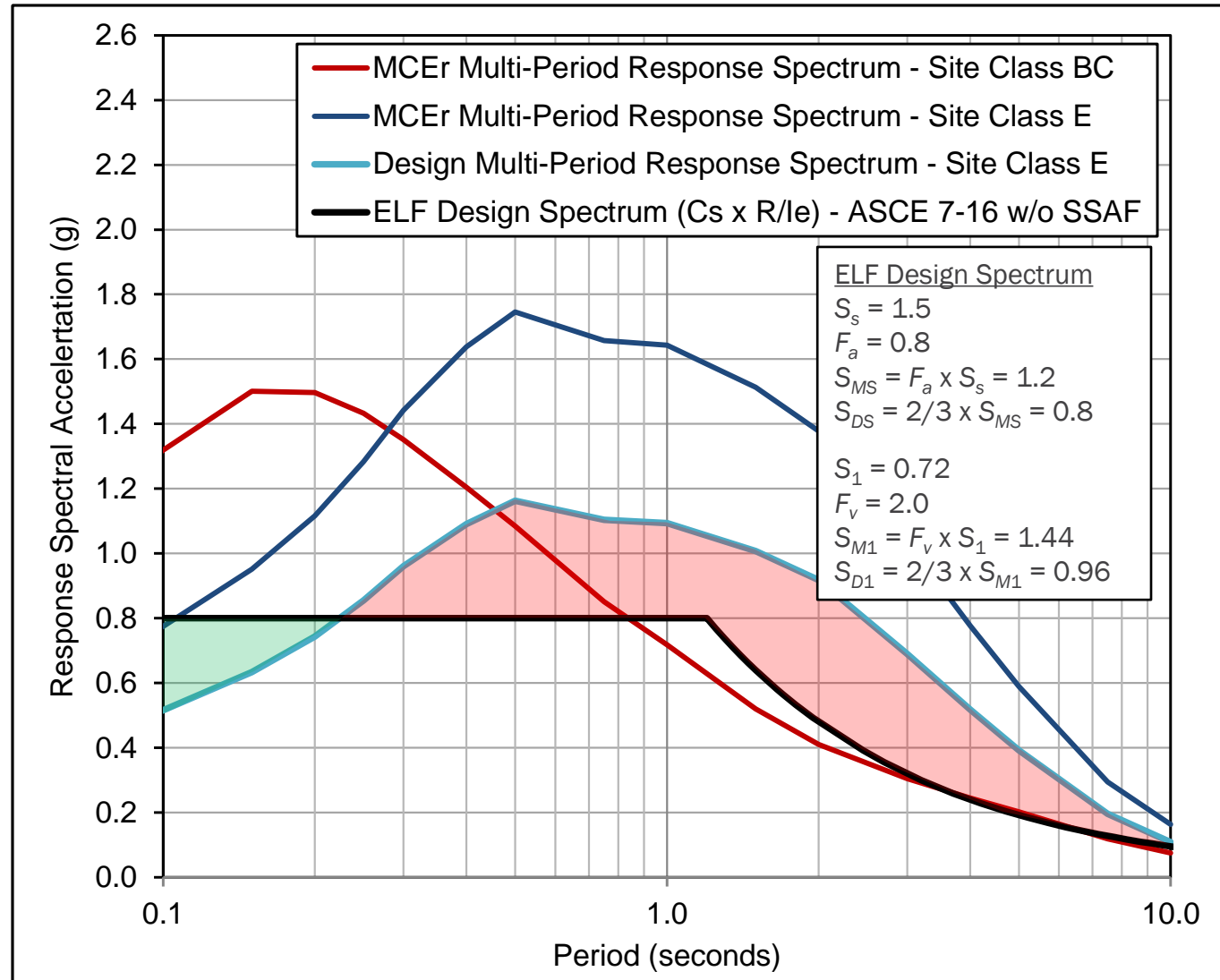

FEMA



Building Seismic Safety Council



Interim Solution of ASCE/SEI 7-16 (2015 NEHRP Provisions)

- Require site-specific analysis to determine design ground motions for softer sites, but
- Provide exceptions to permit design using “conservative” values seismic design parameters



FEMA



Building Seismic
Safety Council



Site-Specific Requirements of Section 11.4.7 of ASCE/SEI 7-16 (2015 NEHRP Provisions)

- Site Class D - Site-specific ground motion procedures are required for structures on Site Class D sites where values of S_1 are greater than or equal to 0.2.
 - An exception permits ELF (and MRSA) design using a “conservative” value of the seismic design coefficient based on a 50 percent increase in the value of the seismic parameter S_{M1} (S_{D1}), effectively extending the acceleration domain to $1.5T_s$



FEMA



Building Seismic
Safety Council



Site-Specific Requirements of Section 11.4.7 of ASCE/SEI 7-16 (2015 NEHRP Provisions)

- Site Class E - Site-specific ground motion procedures required for structures on Site Class E sites where values of S_S are greater than or equal to 1.0 (or S_1 greater than 0.2)
 - An exception permits ELF design using a “conservative” value of the seismic design coefficient based on the seismic parameter S_{MS} (S_{DS}) for Site Class C, regardless of the design period, T , effectively eliminating the velocity domain



FEMA



Building Seismic
Safety Council



Conterminous United States Regions with $S_1 \geq 0.2g$ (ASCE/SEI 7-16)

Orange Shaded Regions
($S_1 \geq 0.2g$)

10 percent of the area
90 percent of the risk
(AEL, FEMA 366)

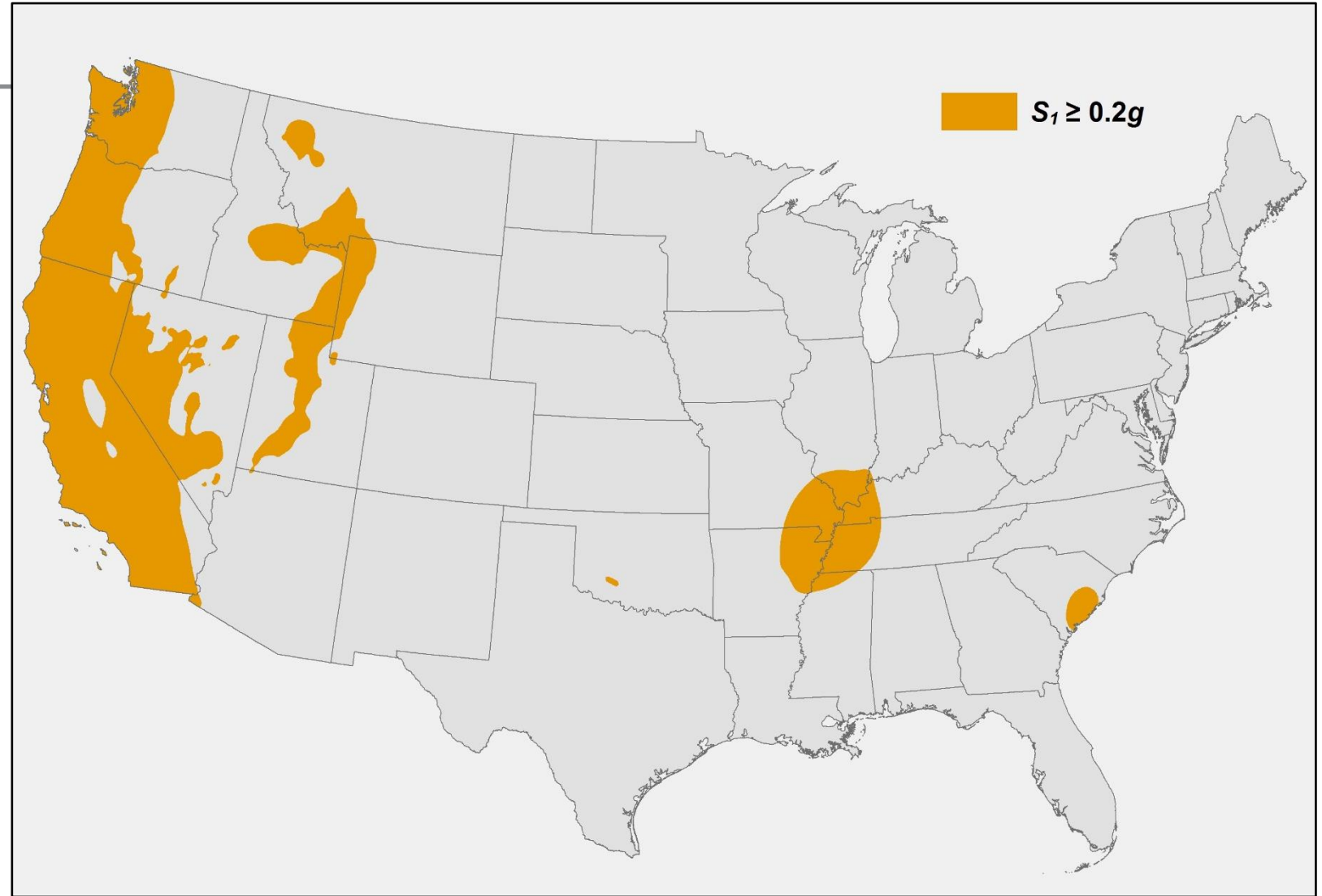

Image source:
USGS



FEMA



Building Seismic
Safety Council



Long-Term Solution - Multi-Period Response Spectra (MPRS) (2020 NEHRP Provisions and ASCE/SEI 7-22)

- Define MCE_R and design ground motions in terms of MPRS (e.g., for MRSA design or as the basis for selecting records for NRHA)
- Derive values of seismic design parameters (e.g., S_{DS} and S_{D1}) from the MPRS of interest (e.g., for ELF design)
- Provide MPRS and associated values of seismic design parameters for User-specified values of:
 - Site Location (latitude, longitude)
 - Site Class
 - From USGS web service at <http://doi.org/10.5066/F7NK3C76> (aka USGS Seismic Design Geodatabase for ASCE/SEI 7-22) and
 - Other User-friendly providers (e.g., WBDG, ASCE 7 Hazard Tool, etc.)



FEMA



Building Seismic
Safety Council



MCE_R Ground Motions (Section 21.2)

(Site-specific requirements of the 2020 NEHRP Provisions and ASCE/SEI 7-22)

- Probabilistic MCE_R Ground Motions (Section 21.2.1):
 - Risk-Targeted – 1% probability of collapse in 50 years
 - Collapse Fragility – 10% probability of collapse given MCE_R ground motions assuming lognormal standard deviation of 0.6 (Risk Category II)
- (New) Deterministic MCE_R Ground Motions (Section 21.2.2):
 - Scenario-Based – 84th percentile ground motions of the governing source (ignoring sources that contribute less than 10% to site hazard)
 - Derived from probabilistic ground motion hazard
 - Not less than deterministic lower-limit MCE_R Ground Motions
- MCE_R Ground Motions (Section 21.2.3):
 - Lesser of probabilistic MCE_R and deterministic MCE_R ground motions



FEMA



Building Seismic
Safety Council



Approach for Developing Multi-Period Response Spectra for United States Regions of Interest (CONUS and OCONUS sites)

- CONUS Sites (WUS and CEUS):
 - Science - 2018 Update of the USGS National Seismic Hazard Model (NSHM)
 - MCE_R Ground Motions – Site-specific requirements of Section 21.2 of the 2020 *NEHRP Provisions* and *ASCE 7-22*
- OCONUS Sites (Alaska, Hawaii, etc.):
 - Science – Most current values of S_S and S_1 (and T_L)
 - MCE_R Ground Motions – Site-specific requirements of Section 21.2 of the 2020 *NEHRP Provisions* and *ASCE/SEI 7-22* and the MPRS procedures of FEMA P-2018
- FEMA P-2078 (FEMA-funded ATC-136-1 Project)
 - “Procedures for Developing Multi-Period Response Spectra at Non-Conterminous United States Sites,” FEMA P-2078, June 2020.



FEMA



Building Seismic
Safety Council



Multi-Period Response Spectra Format

(example matrix showing the combinations of twenty-two response periods, plus PGA_G , and eight hypothetical site classes of the standard format of multi-period response spectra)

- CONUS regions with ground motion models for all 22 x 8 combinations of site class and period (USGS 2018 NSHM):
 - WUS
 - CEUS

Period T (s)	5%-Damped Response Spectral Acceleration or PGA_G by Site Class (g)							
	A	B	BC	C	CD	D	DE	E
0.00	0.501	0.565	0.658	0.726	0.741	0.694	0.607	0.547
0.010	0.503	0.568	0.662	0.730	0.748	0.703	0.617	0.547
0.020	0.519	0.583	0.676	0.739	0.749	0.703	0.617	0.547
0.030	0.596	0.662	0.750	0.792	0.778	0.703	0.617	0.547
0.050	0.811	0.888	0.955	0.958	0.888	0.758	0.620	0.551
0.075	1.040	1.142	1.214	1.193	1.076	0.900	0.713	0.624
0.10	1.119	1.252	1.371	1.368	1.241	1.040	0.825	0.724
0.15	1.117	1.291	1.535	1.606	1.497	1.266	1.002	0.875
0.20	1.012	1.194	1.500	1.710	1.662	1.440	1.153	1.010
0.25	0.897	1.075	1.397	1.714	1.766	1.584	1.299	1.153
0.30	0.810	0.976	1.299	1.665	1.829	1.705	1.443	1.301
0.40	0.689	0.833	1.138	1.525	1.823	1.802	1.607	1.484
0.50	0.598	0.724	1.009	1.385	1.734	1.803	1.681	1.596
0.75	0.460	0.536	0.760	1.067	1.407	1.566	1.598	1.589
1.0	0.368	0.417	0.600	0.859	1.168	1.388	1.512	1.578
1.5	0.261	0.288	0.410	0.600	0.839	1.086	1.348	1.540
2.0	0.207	0.228	0.309	0.452	0.640	0.877	1.192	1.458
3.0	0.152	0.167	0.214	0.314	0.449	0.632	0.889	1.111
4.0	0.120	0.132	0.164	0.238	0.339	0.471	0.655	0.815
5.0	0.100	0.109	0.132	0.188	0.263	0.359	0.492	0.607
7.5	0.063	0.068	0.080	0.110	0.148	0.194	0.256	0.311
10	0.042	0.045	0.052	0.069	0.089	0.113	0.144	0.170
PGA_G	0.373	0.429	0.500	0.552	0.563	0.527	0.461	0.416



FEMA



Building Seismic Safety Council



Multi-Period Response Spectra Format

(example matrix showing the combinations of twenty-two response periods, plus PGA_G , and eight hypothetical site classes of the standard format of multi-period response spectra)

- CONUS regions with ground motion models for all 22 x 8 combinations of site class and period (USGS 2018 NSHM):
 - WUS
 - CEUS
- OCONUS regions with only two ground motion response parameters (S_S and S_1) and PGA (2018 USGS NSHM):
 - Alaska
 - Hawaii
 - Puerto Rico and the Virgin Islands
 - Guam and American Samoa

Period T (s)	5%-Damped Response Spectral Acceleration or PGA by Site Class (g)							
	A	B	BC	C	CD	D	DE	E
0.00	0.501	0.565	0.658	0.726	0.741	0.694	0.607	0.547
0.010	0.503	0.568	0.662	0.730	0.748	0.703	0.617	0.547
0.020	0.519	0.583	0.676	0.739	0.749	0.703	0.617	0.547
0.030	0.596	0.662	0.750	0.792	0.778	0.703	0.617	0.547
0.050	0.811	0.888	0.955	0.958	0.888	0.758	0.620	0.551
0.075	1.040	1.142	1.214	1.193	1.076	0.900	0.713	0.624
0.10	1.119	1.252	1.371	1.368	1.241	1.040	0.825	0.724
0.15	1.117	1.291	1.535	1.606	1.497	1.266	1.002	0.875
0.20	1.012	1.194	1.500	1.710	1.662	1.440	1.153	1.010
0.25	0.897	1.075	1.397	1.714	1.766	1.584	1.299	1.153
0.30	0.810	0.976	1.299	1.665	1.829	1.705	1.443	1.301
0.40	0.689	0.833	1.138	1.525	1.823	1.802	1.607	1.484
0.50	0.598	0.724	1.009	1.385	1.734	1.803	1.681	1.596
0.75	0.460	0.536	0.760	1.067	1.407	1.566	1.598	1.589
1.0	0.368	0.417	0.600	0.859	1.168	1.388	1.512	1.578
1.5	0.261	0.288	0.410	0.600	0.839	1.086	1.348	1.540
2.0	0.207	0.228	0.309	0.452	0.640	0.877	1.192	1.458
3.0	0.152	0.167	0.214	0.314	0.449	0.632	0.889	1.111
4.0	0.120	0.132	0.164	0.238	0.339	0.471	0.655	0.815
5.0	0.100	0.109	0.132	0.188	0.263	0.359	0.492	0.607
7.5	0.063	0.068	0.080	0.110	0.148	0.194	0.256	0.311
10	0.042	0.045	0.052	0.069	0.089	0.113	0.144	0.170
PGA_G	0.373	0.429	0.500	0.552	0.563	0.527	0.461	0.416



FEMA



Building Seismic Safety Council



Example Multi-Period Response Spectra (MPRS)

(showing the new deterministic MCE_R Lower Limit, Table 21.2-1, 2020 *NEHRP Provisions* and ASCE/SEI 7-22, which are anchored to $S_S = S_{SD} = 1.5$ g, $S_1 = S_{1D} = 0.6$ g)

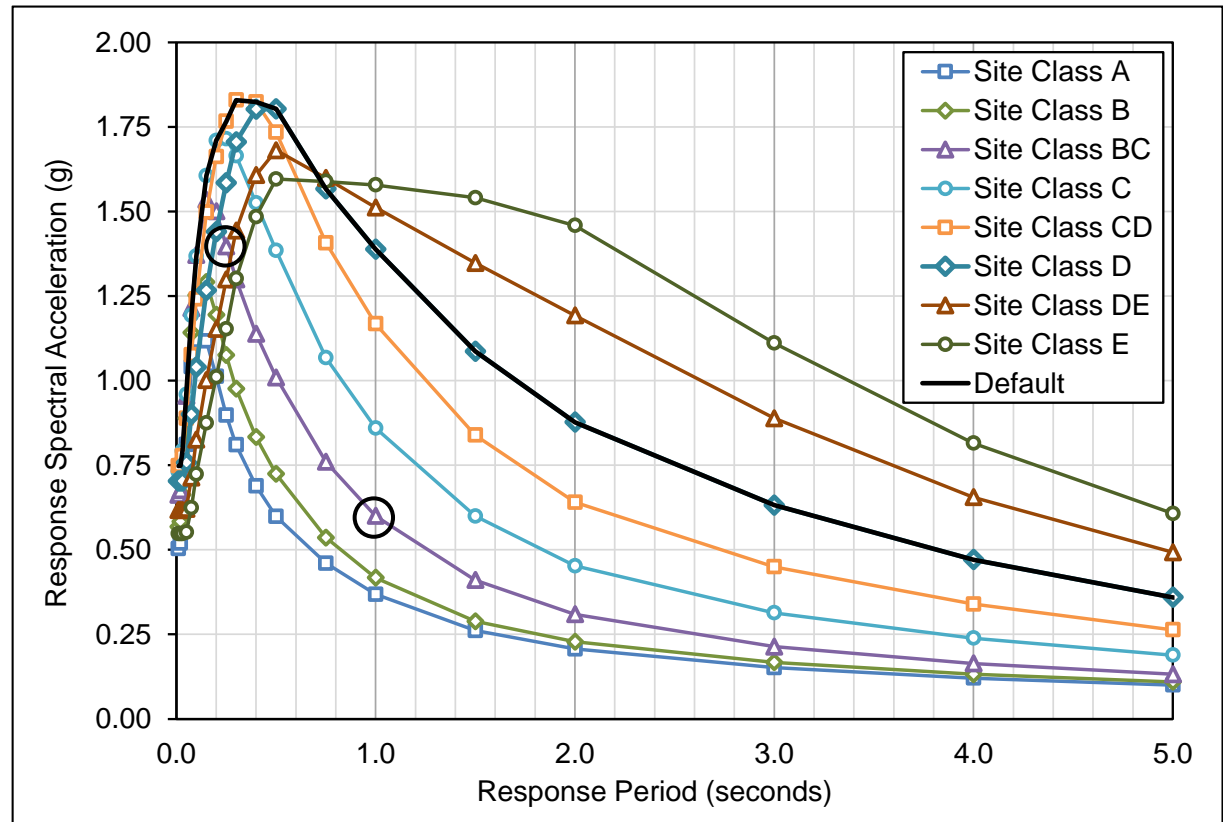
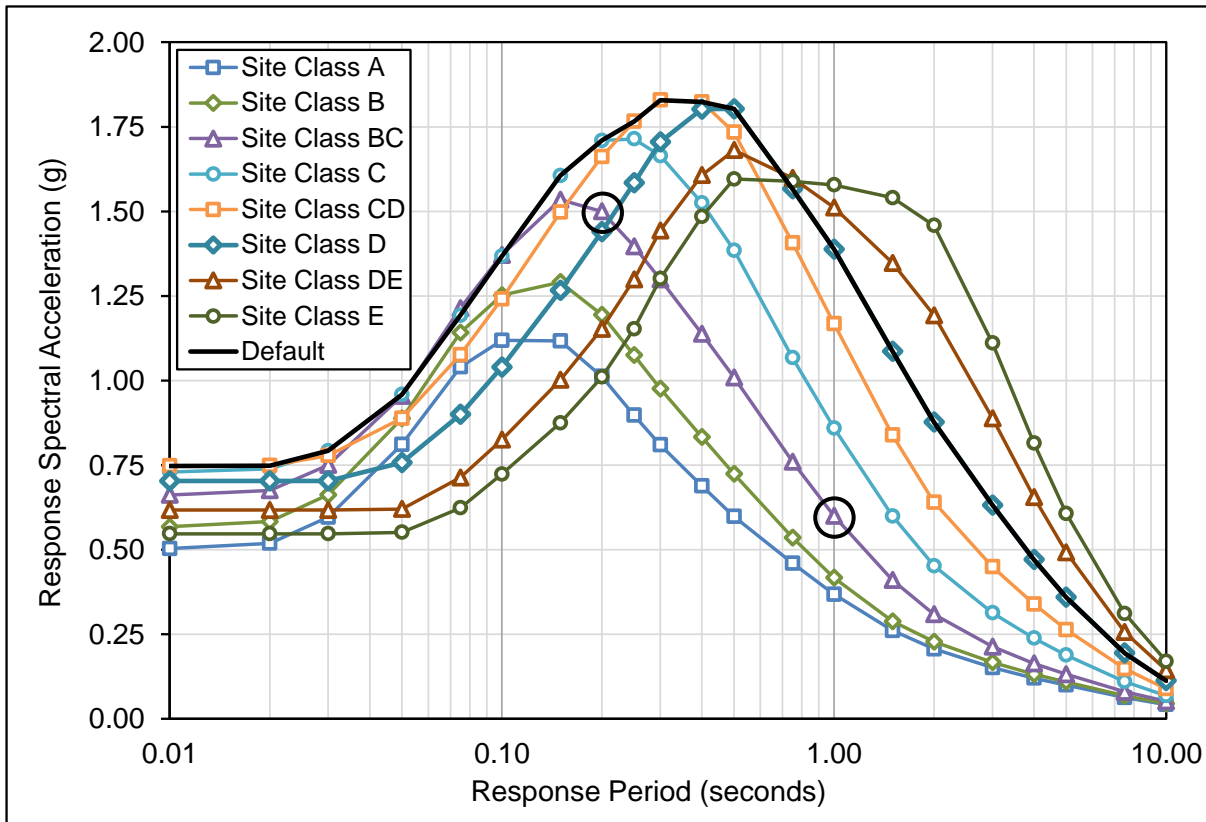

FEMA



Building Seismic Safety Council



Conterminous United States Regions Governed Solely by Probabilistic MCE_R Ground Motions for Default Site Conditions

Non-Orange Shaded Regions
(Deterministic MCE_R)
> 90 percent of the area
 \approx 10 percent of the risk
(AEL, FEMA 366)

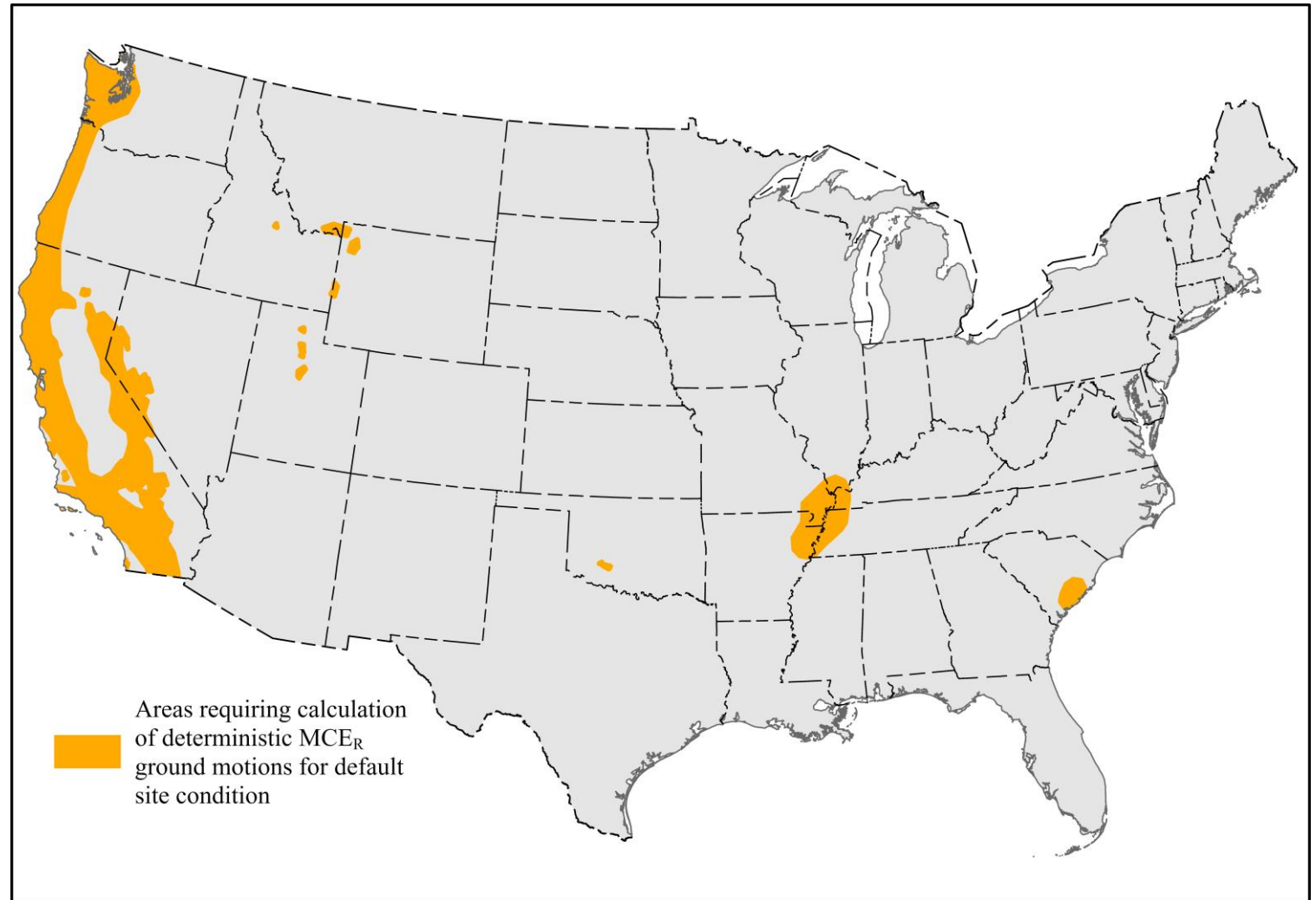

Image source:
USGS



FEMA



Building Seismic
Safety Council



New Site Classes and Associated Values of Shear Wave Velocities (Table 2.2-1, FEMA P-2078, June 2020)

Site Class		Shear Wave Velocity, V_{s30} (fps)			USGS ² V_{s30} (mps)
Name	Description	Lower Bound ¹	Upper Bound ¹	Center	
A	Hard rock	5,000			1,500
B	Medium hard rock	3,000	5,000	3,536	1,080
BC	Soft rock	2,100	3,000	2,500	760
C	Very dense soil or hard clay	1,450	2,100	1,732	530
CD	Dense sand or very stiff clay	1,000	1,450	1,200	365
D	Medium dense sand or stiff clay	700	1,000	849	260
DE	Loose sand or medium stiff clay	500	700	600	185
E	Very loose sand or soft clay		500		150

1. Upper and lower bounds, Table 20.3-1, ASCE/SEI 7-22.
2. Center of range (rounded) values used by USGS to develop MPRS.



FEMA



Building Seismic
Safety Council



Distribution of 9,050 of Census Tracts of Densely Populated Areas of California, Oregon and Washington by Site Class (90% of Population)

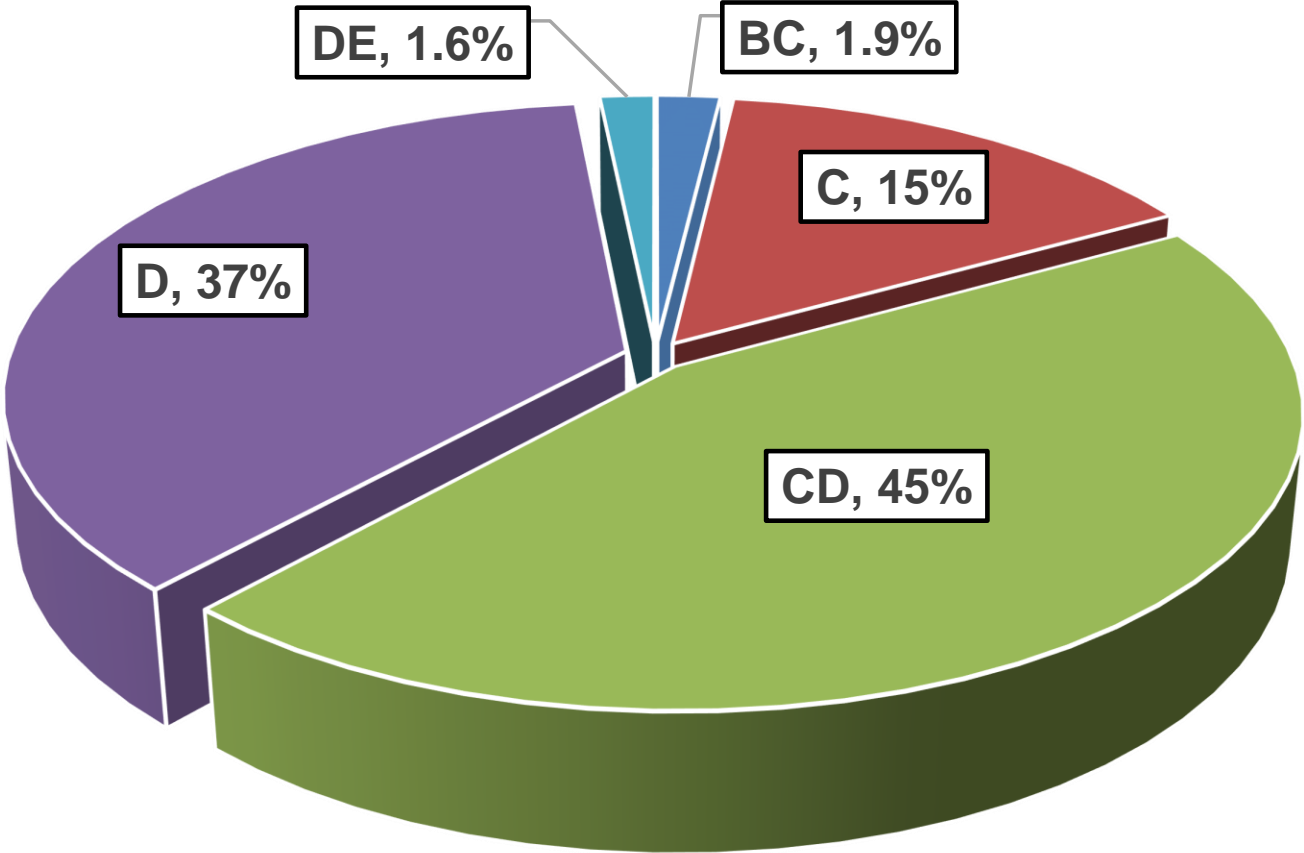

*from Table A.2-1,
FEMA P-2078,
June 2020*



FEMA



Building Seismic
Safety Council



Improved Values of Seismic Design Parameters

- Derive values of seismic design parameters (S_{DS} and S_{D1}) from “best fit” of the 2-period spectrum to the multi-period design spectrum of the site of interest
- “Best Fit” based on site-specific requirements of Section 21.4:
 - S_{DS} based on 90% of peak short-period response (acceleration domain)
 - S_{D1} Based on 90% of peak response in the velocity domain (not less than 100% of 1-second response)



FEMA



Building Seismic
Safety Council



Example Derivation of S_{DS} and S_{D1} from a Multi-Period Design Spectrum

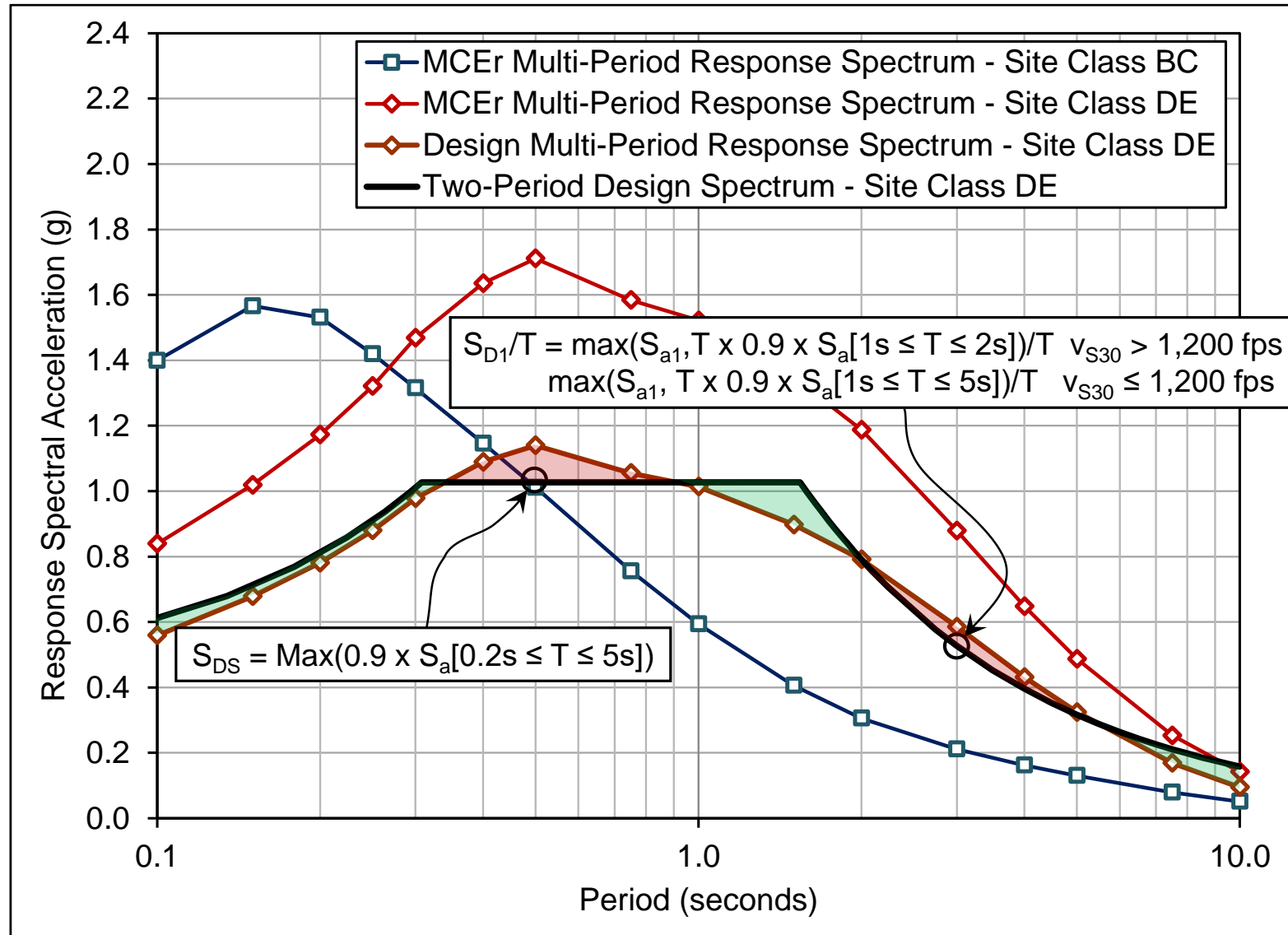

Comparison of ASCE/SEI 7-16 Two-Period (ELF) Design Spectrum w/o Spectrum Shape Adjustment and Multi-Period Response Spectra based on M8.0 earthquake ground motions at $R_x = 9.9$ km) – Site Class E

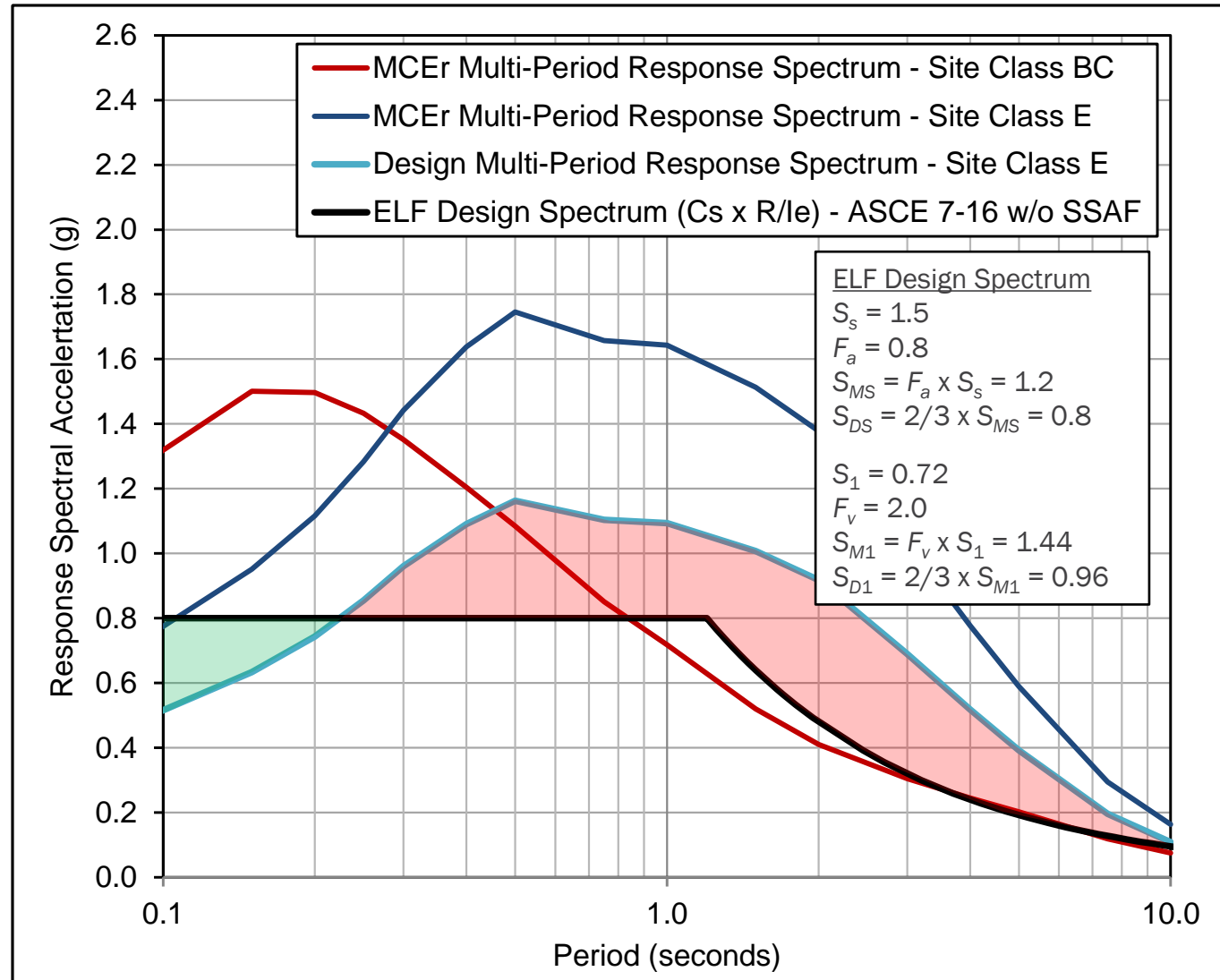

FEMA



Building Seismic Safety Council



Multi-Period Design Spectrum

(Figure 11.4-1, 2020 NEHRP Provisions and ASCE/SEI 7-22 with annotation)

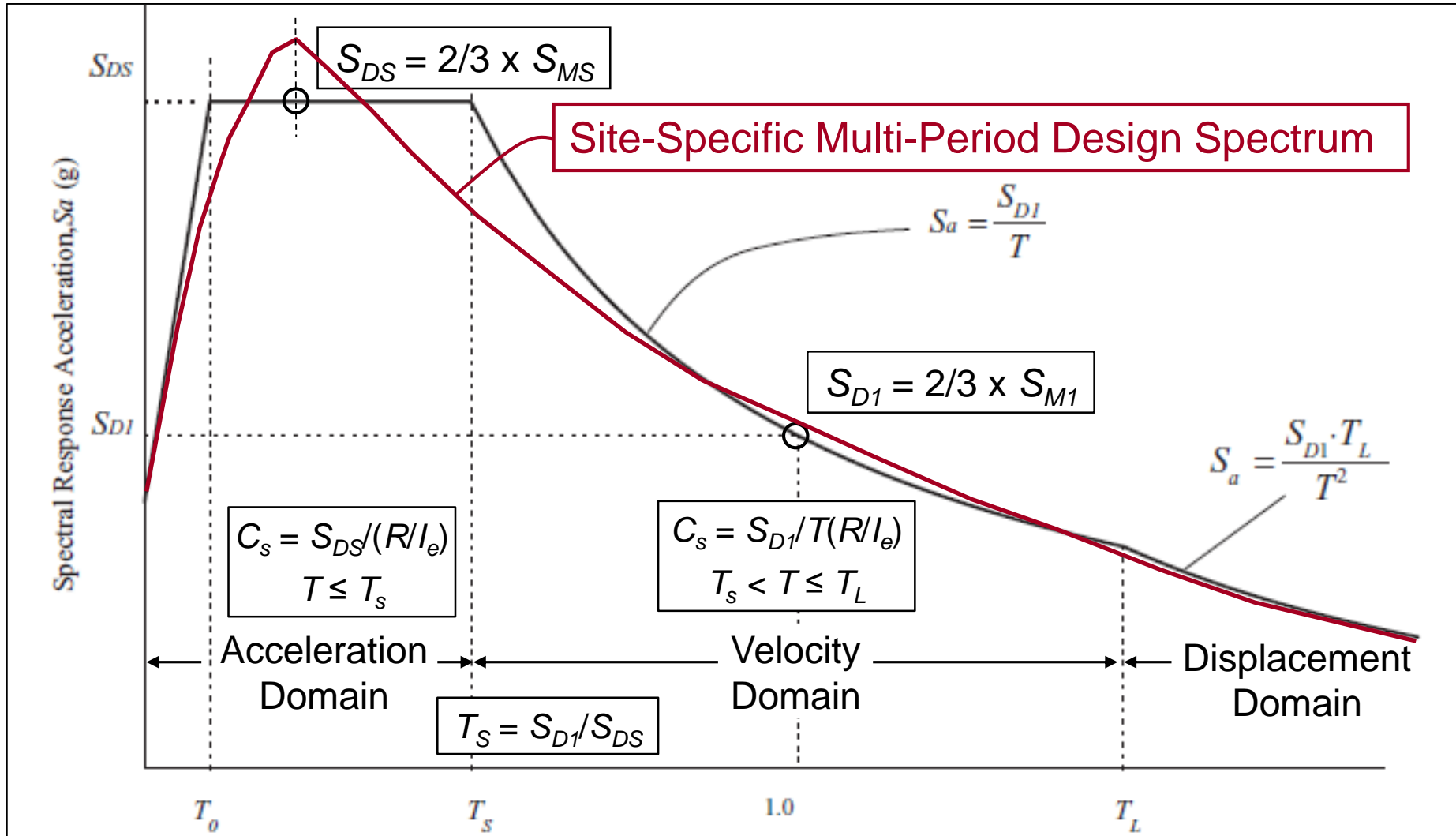

FEMA



Building Seismic Safety Council



Example Comparisons of Design Spectra (default site conditions)

- By Seismic Code Vintage
 - ASCE/SEI 7-10 - Two-period design spectrum
 - ASCE/SEI 7-16 - Two-period design spectrum
 - 2020 NEHRP Provisions (ASCE/SEI 7-22) - Multi-period design spectrum
 - 2020 NEHRP Provisions (ASCE/SEI 7-22) - Two-period design spectrum (for comparison with two-period spectra of ASCE/SEI 7-10 and ASCE/SEI 7-16)
- By Location
 - Irvine – WUS “probabilistic” site (magnitude M7.0 – M7.5)
 - San Mateo – WUS “deterministic” site (magnitude M7.5 - M8.0)
 - Anchorage – OCONUS “deterministic” site (magnitude M8.0 – M9.0)
 - Memphis – CEUS “probabilistic/deterministic” site (magnitude M7.5 – M8.0)



FEMA



Building Seismic
Safety Council



Comparison of Design Response Spectra – Irvine

(assuming default site conditions, Figure 8.2-1, FEMA P-2078, June 2020)

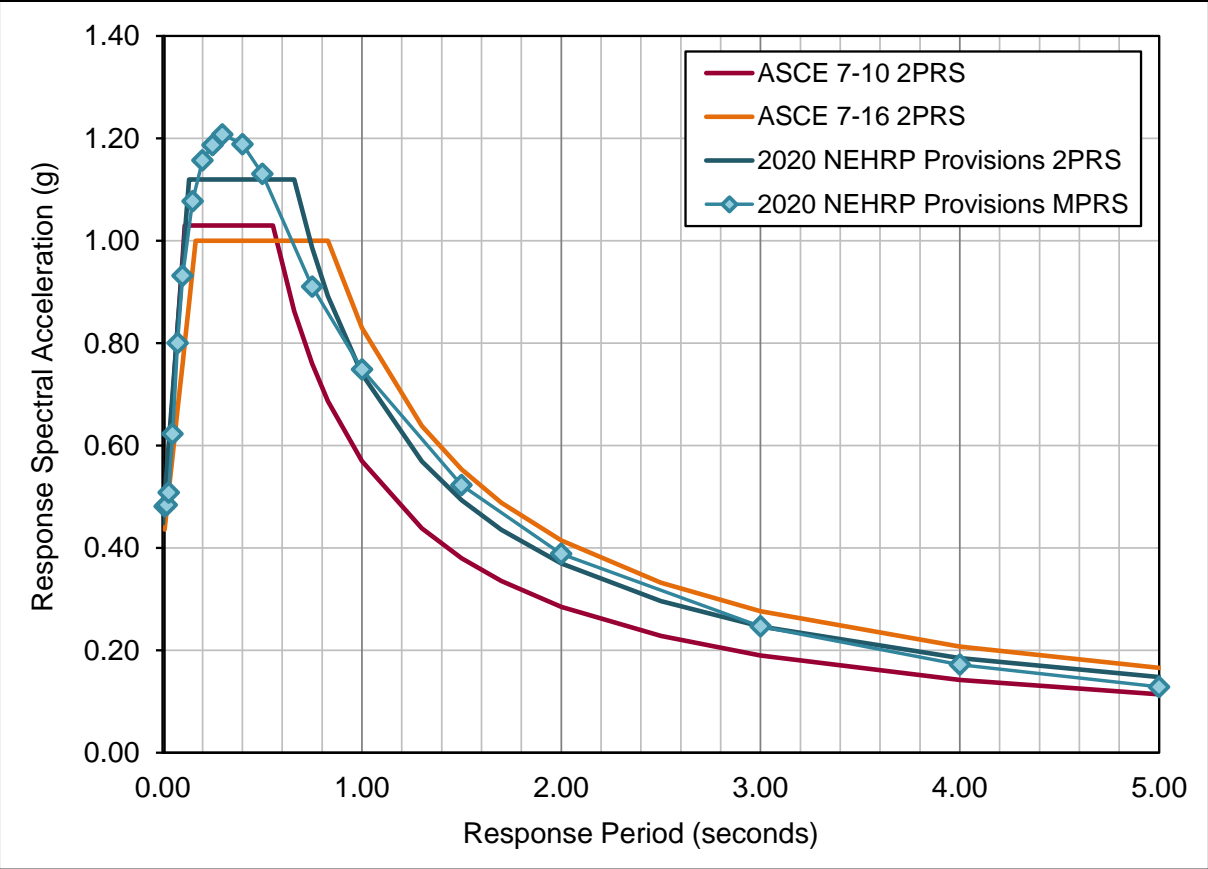
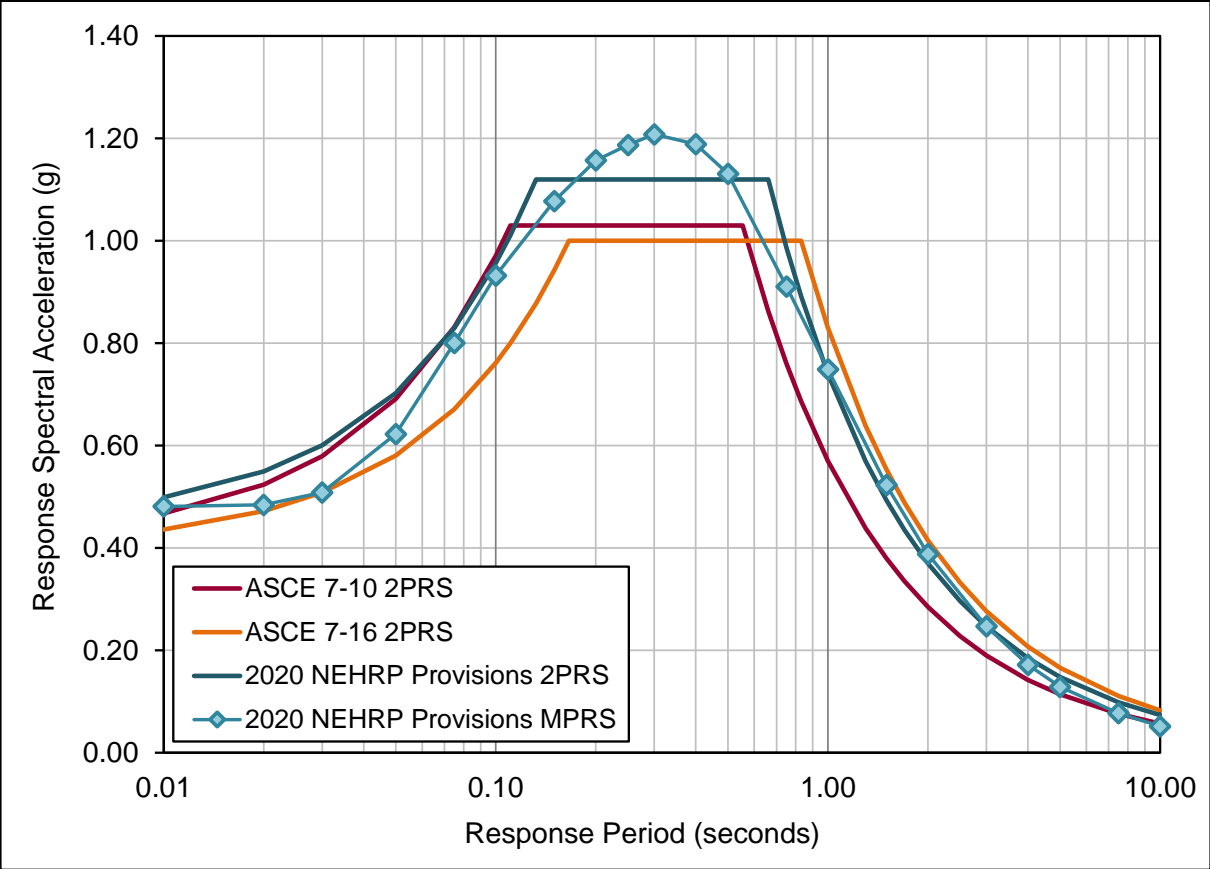

Velocity domain of the ASCE/SEI 7-16 (2PRS) design spectrum includes the 1.5 multiplier of the applicable Section 11.4.8 exception.



FEMA

Building Seismic Safety Council



Comparison of Design Response Spectra – San Mateo

(assuming default site conditions, Figure 8.2-2, FEMA P-2078, June 2020)

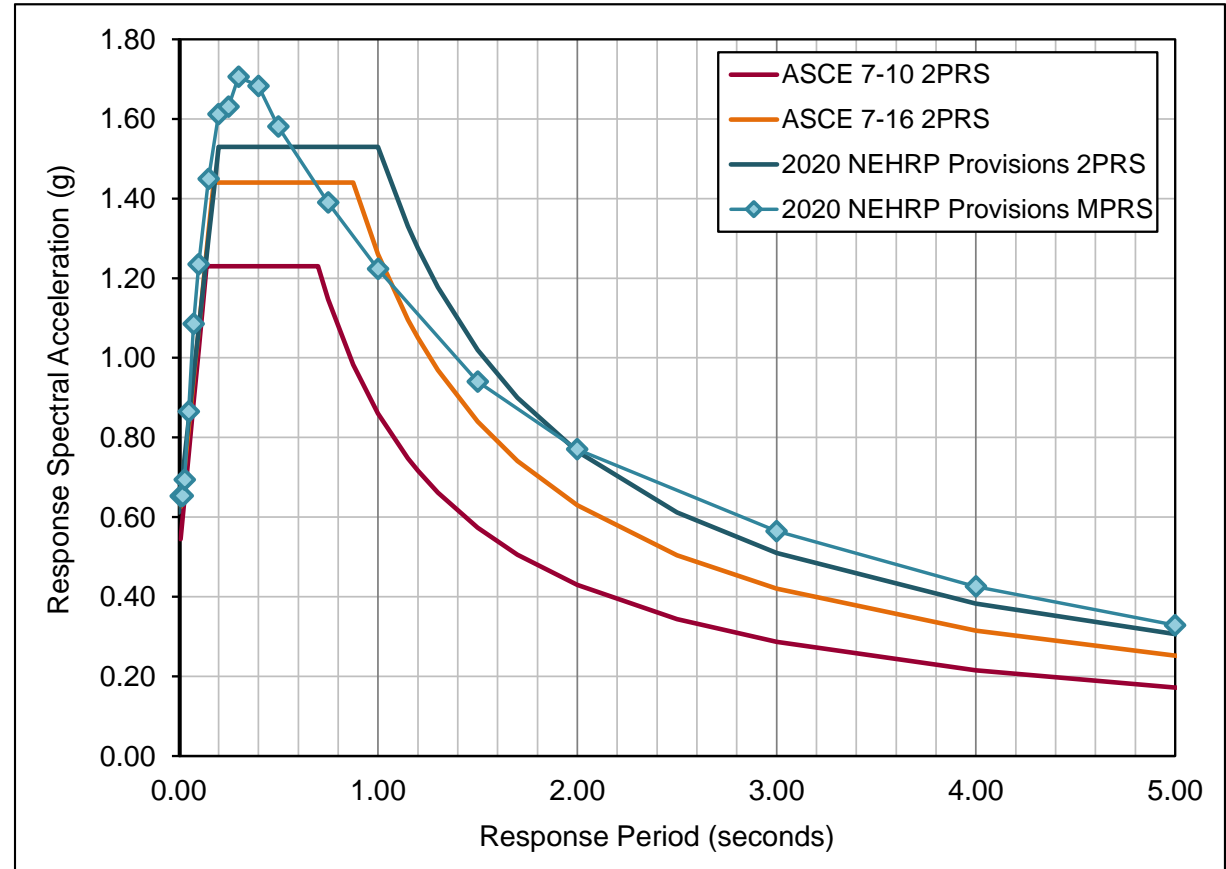
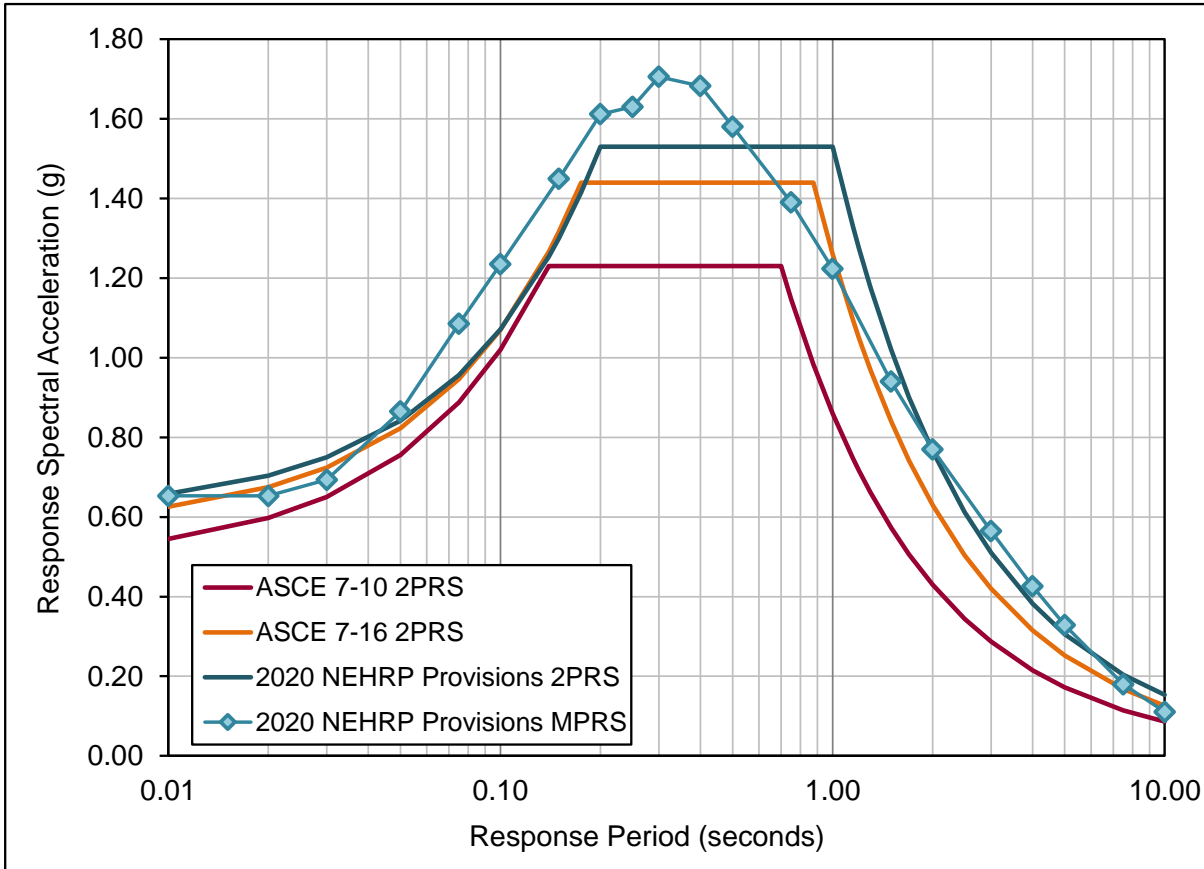

Velocity domain of the ASCE/SEI 7-16 (2PRS) design spectrum includes the 1.5 multiplier of the applicable Section 11.4.8 exception.



FEMA



Building Seismic Safety Council



Comparison of Design Response Spectra – Anchorage

(assuming default site conditions, Figure 8.2-4, FEMA P-2078, June 2020)

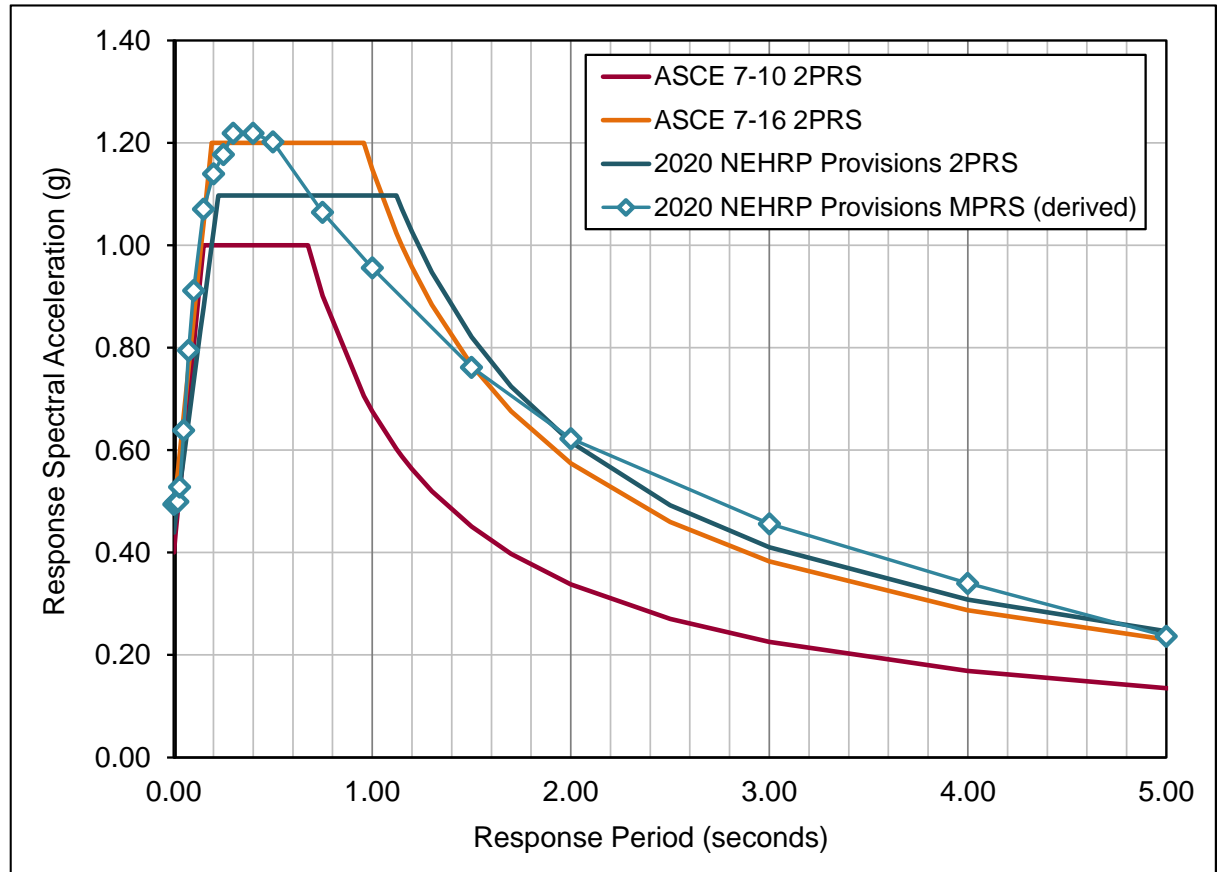
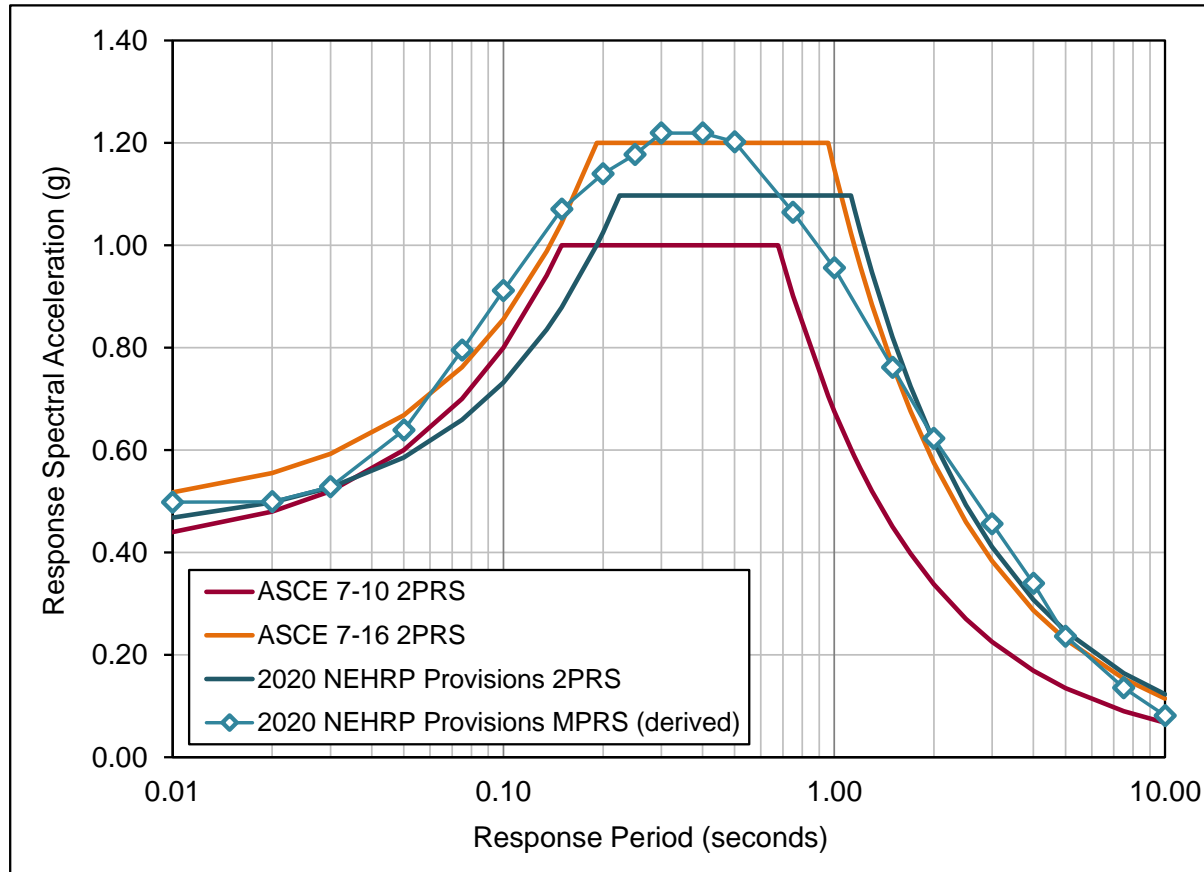

Velocity domain of the ASCE/SEI 7-16 (2PRS) design spectrum includes the 1.5 multiplier of the applicable Section 11.4.8 exception.

Derived MPRS based on:
 $S_S = 1.50$ g (deterministic MCE_R floor)
 $S_1 = 0.65$ g (deterministic MCE_R)
 $T_L = 16$ s ($M = 8.0 - 8.5$)



FEMA



Building Seismic Safety Council



Comparison of Design Response Spectra – Memphis

(assuming default site conditions, Figure 8.2-4, FEMA P-2078, June 2020)

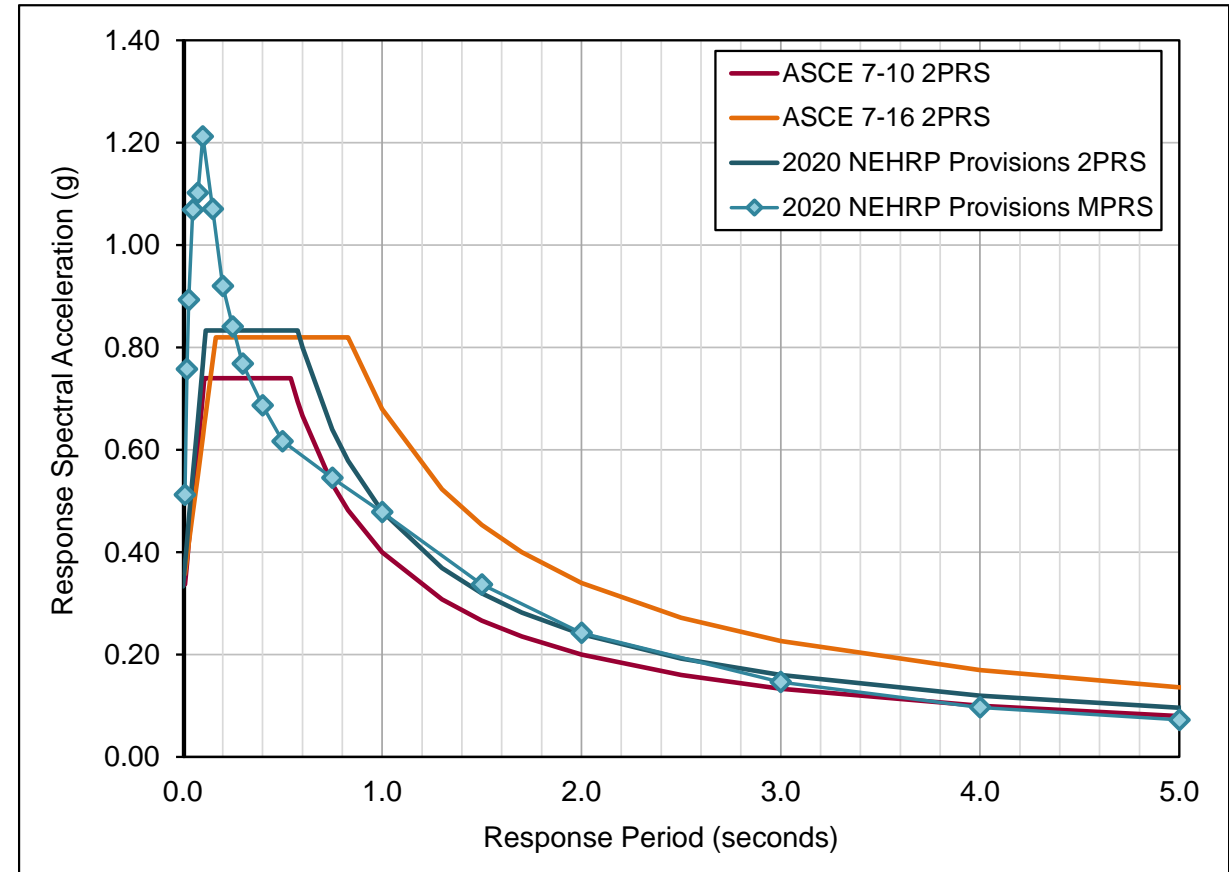
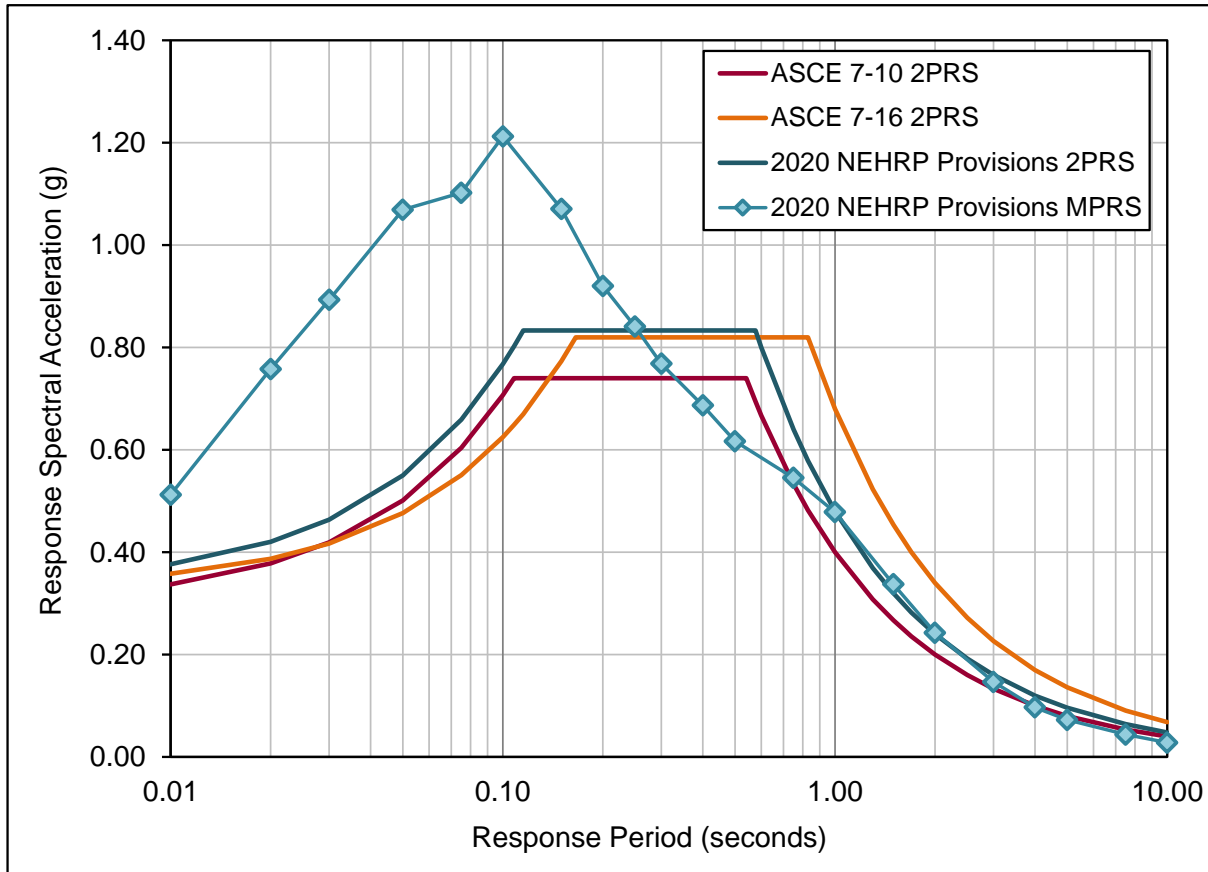

Velocity domain of the ASCE/SEI 7-16 (2PRS) design spectrum includes the 1.5 multiplier of the applicable Section 11.4.8 exception.



FEMA



Building Seismic Safety Council



Design (As Usual) Using New MPRS

- Design Ground Motions
 - Ground motion parameters (and MPRS) are available online from a USGS web service [<https://doi.org/10.5066/F7NK3C76>] for user specified site location (i.e., latitude and longitude) and site conditions (i.e., site class)
 - Site-specific ground motion procedures (Chapter 21) now permit use of MPRS obtained online from the USGS web service (in lieu of a hazard analysis)
- Design Procedures
 - ELF procedures (Chapter 12) are not affected by proposed changes (although values of design parameters, S_{DS} and S_{D1} , would better match the underlying response spectrum of the site of interest)
 - MRSA procedures (Chapter 12) are not affected by proposed changes (although multi-period design spectra would provide a more reliable calculation of dynamic response)



FEMA



Building Seismic
Safety Council



Questions



FEMA



Building Seismic
Safety Council



DISCLAIMER

- NOTICE: Any opinions, findings, conclusions, or recommendations expressed in this publication do not necessarily reflect the views of the Federal Emergency Management Agency. Additionally, neither FEMA, nor any of its employees make any warranty, expressed or implied, nor assume any legal liability or responsibility for the accuracy, completeness, or usefulness of any information, product or process included in this publication.
- The opinions expressed herein regarding the requirements of the *NEHRP Recommended Seismic Provisions*, the referenced standards, and the building codes are not to be used for design purposes. Rather the user should consult the jurisdiction's building official who has the authority to render interpretation of the code.
- This training material presentation is intended to remain complete in its entirety even if used by other presenters. While the training material could be tailored for use in other presentations, we caution users to account for issues of completeness and interpretation if only part of the material is used. We also strongly suggest users give proper credit/citation to this presentation and its author.



FEMA



Building Seismic
Safety Council



Chapter 3 (Section 3.4) Additional Revisions to Ground-Motion Provisions

2020 NEHRP Provisions Training Materials

C.B. Crouse, PhD, PE, AECOM



FEMA



Building Seismic
Safety Council

| BSSC



Presentation

- Maximum Considered Earthquake Geometric Mean (MCE_G) Peak Ground Acceleration (ASCE/SEI 7-22, Section 21.5)
- Vertical Ground Motion for Seismic Design (ASCE/SEI 7-22, Section 11.9)
- Site Class when Shear Wave Velocity Data Unavailable (ASCE/SEI 7-22, Section 20.3)



FEMA



Building Seismic
Safety Council



MCE_G Peak Ground Acceleration (ASCE/SEI 7-22, Section 21.5)

- **Background:** In ASCE/SEI 7-16, Section 11.8.3, MCE_G Peak Ground Acceleration (PGA_M) was
 - $PGA_M = F_{PGA} PGA$ (Equation 11.8-1)
- where F_{PGA} = site coefficient; and, PGA = Mapped MCE_G Peak Ground Acceleration
- In Section 21.5.2 Deterministic MCE_G Peak Ground Acceleration, lower limit set at
 - $0.5 F_{PGA}$



FEMA



Building Seismic
Safety Council



MCE_G Peak Ground Acceleration (ASCE/SEI 7-22, Section 21.5)

- **Update:** In ASCE/SEI 7-22, site coefficients eliminated because of MPRS
 - PGA_M in Section 11.8.3 obtained from USGS Seismic Design Geodatabase for the applicable site class.
 - Deterministic lower limit value listed in bottom row of Table 21.2-1, ASCE/SEI 7-22

Table 21.2-1 (Bottom Row) Deterministic Lower Limit Values of PGA_G (g)

Period T (s)	Site Class							
	A	B	BC	C	CD	D	DE	E
PGA_G	0.37	0.43	0.50	0.55	0.56	0.53	0.46	0.42



FEMA



Building Seismic Safety Council



Additional Revisions (ASCE/SEI 7-22, Section 21.5)

- **Section 21.5.2 Deterministic MCE_G Peak Ground Acceleration:**
- Replaces “characteristic earthquakes” with “scenario earthquakes”
 - Determined from disaggregation of probabilistic MCE_G peak ground acceleration.
 - From PSHA output, obtain mean magnitude, M , and mean rupture distance, R_{rup} , for each fault and its % contribution to probabilistic MCE_G peak ground acceleration. The M and R_{rup} define the “scenario earthquake”
 - scenario earthquakes contributing < 10% of the largest contributor shall be ignored.

Example: Fault X has 75% contribution (largest)

Fault Y has 20% contribution (included)

Fault Z has 6% contribution (ignored)



FEMA



Building Seismic
Safety Council



Additional Revisions (ASCE/SEI 7-22, Section 21.5)

- **Section 21.5.3 Site-Specific MCE_G Peak Ground Acceleration:**
- Determination of MCE_G PGA similar in ASCE/SEI 7-16 & 7-22, i.e.,
 - Take lower of probabilistic & deterministic MCE_G PGA
 - Resulting MCE_G PGA must be $\geq 80\%$ of MCE_G PGA from USGS Seismic Design Geodatabase



FEMA



Building Seismic
Safety Council



Vertical Ground Motion (ASCE/SEI 7-22, Section 11.9)

- **Background:** First introduced in ASCE/SEI 7-16 as S_{aMv}
 - Provision optional
 - S_{aMv} given by Equations (11.9-1 through 11.9-4) for four specific T_v ranges
 - S_{aMv} derived from vertical/horizontal (V/H) component ratios applied to $MCE_R S_a(T)$
 - Limitation: No S_{aMv} equation for $T_v > 2$ sec; site-specific determination required
 - Oversight: H component in V/H ratio was geomean; $MCE_R S_a(T)$ was for direction of maximum shaking



FEMA



Building Seismic
Safety Council



Vertical Ground Motion (ASCE/SEI 7-22, Section 11.9)

- **Update:** Limitation & Oversight corrected in ASCE/SEI 7-22 S_{aMv}
 - Introduced S_{aMv} Equation (11.9-5) for $T_v > 2$ sec
 - Corrected oversight by dividing $MCE_R S_{aM}$, by F_{md} to covert max direction S_a to geomean S_a
 - F_{md} given by Equations (11.9-6 through 11.9-8) for three specific T_v ranges
 - F_{md} based on Shahi & Baker (2014)
- Vertical coefficient, C_v , also revised to accommodate the nine site classes
 - New C_v values in Table 11.9-1
 - C_v depend on S_{MS} (not S_S in Table 11.9-1 of ASCE/SEI 7-16)



FEMA



Building Seismic
Safety Council



Vertical Ground Motion (ASCE/SEI 7-22, Section 11.9)

- **Example:** Comparison of S_{aMv} and S_{aM} for Irvine, CA site and Site Class D

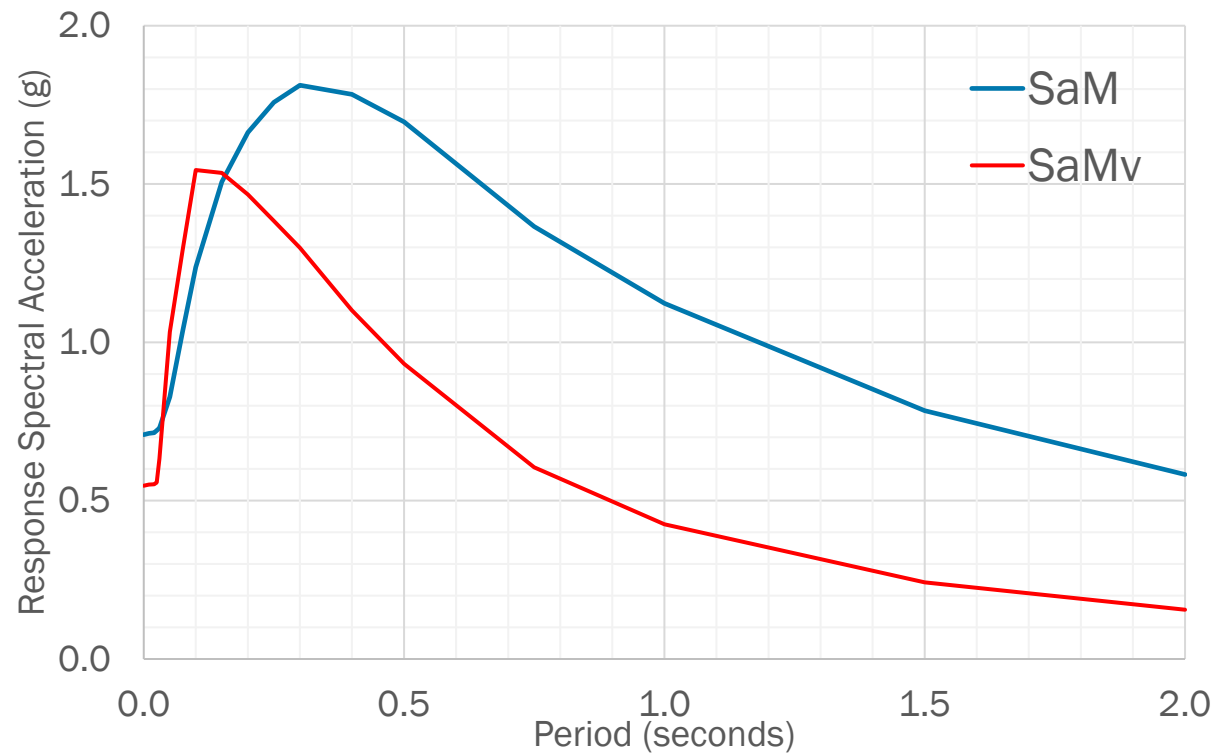

FEMA



Building Seismic
Safety Council



Site Class when Shear Wave Velocity Data Unavailable (ASCE/SEI 7-22, Section 20.3)

- **Background:** In Section 20.3 of ASCE/SEI 7-16, site class determined from either
 - \bar{v}_s - average shear-wave velocity in upper 100 ft (30 m)
 - N - average STP in upper 100 ft (30 m)
 - s_u - average undrained shear strength in upper 100 ft (30 m)
 - Ranges of these parameters for each site class provided in Table 20.3-1
- **Update:** In Section 20.2 of ASCE/SEI 7-22, Table 20.2-1 only includes \bar{v}_s ; N and S_u have been eliminated



FEMA



Building Seismic
Safety Council



Site Class when Shear Wave Velocity Data Unavailable (ASCE/SEI 7-22, Section 20.3)

- **Reasons for Revisions to Table 20.3-1:**
 - \bar{v}_s is better indicator of site response effects
 - N and s_u ranges were outdated and had no solid technical basis
 - Encourage the use of shear-wave velocity (V_s) measurements
- **Provision when V_s not Measured:**
 - Use applicable correlations between V_s & N , or V_s & CPT, etc. to obtain V_s profile
 - Compute \bar{v}_s from V_s profile
 - Determine site classes from \bar{v}_s , $1.3 \bar{v}_s$, and $\bar{v}_s/1.3$
 - Select most critical site class at each T , i.e., one resulting in largest $MCE_R S_a$



FEMA



Building Seismic
Safety Council



Site Class when Shear Wave Velocity Data Unavailable

- **Hypothetical Example:** Irvine, CA site
 - Vs profile constructed from correlation with another soil parameter
 - \bar{v}_s computed as 850 ft/sec (Site Class D)
 - $1.3 \bar{v}_s = 1,105$ ft/sec (Site Class CD)
 - $\bar{v}_s/1.3 = 654$ ft/sec (Site Class DE)



FEMA



Building Seismic
Safety Council



Site Class when Shear Wave Velocity Data Unavailable

- **Hypothetical Example:** Irvine, CA site. Envelope of three S_{aM} must be taken.

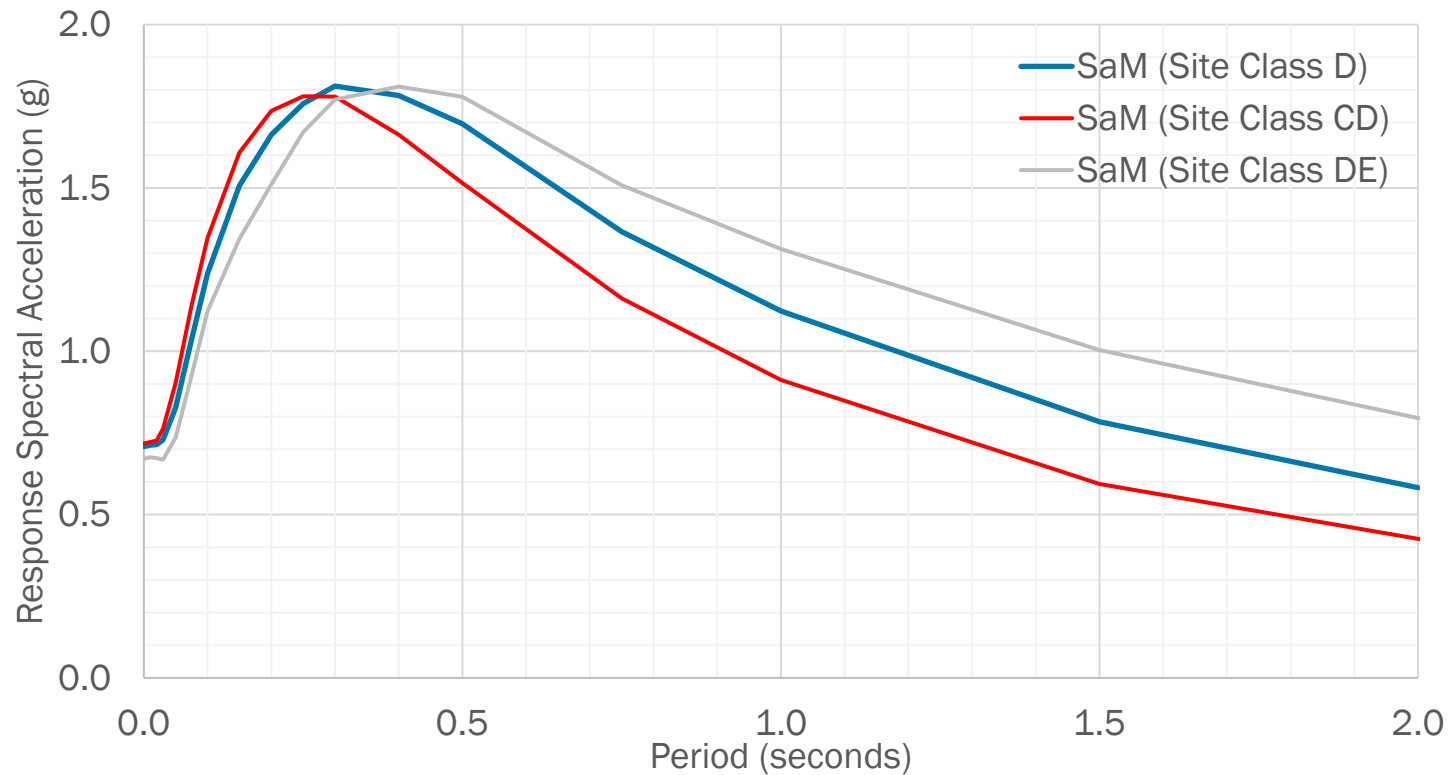

FEMA



Building Seismic Safety Council



Questions



FEMA



Building Seismic
Safety Council



DISCLAIMER

- NOTICE: Any opinions, findings, conclusions, or recommendations expressed in this publication do not necessarily reflect the views of the Federal Emergency Management Agency. Additionally, neither FEMA, nor any of its employees make any warranty, expressed or implied, nor assume any legal liability or responsibility for the accuracy, completeness, or usefulness of any information, product or process included in this publication.
- The opinions expressed herein regarding the requirements of the *NEHRP Recommended Seismic Provisions*, the referenced standards, and the building codes are not to be used for design purposes. Rather the user should consult the jurisdiction's building official who has the authority to render interpretation of the code.
- This training material presentation is intended to remain complete in its entirety even if used by other presenters. While the training material could be tailored for use in other presentations, we caution users to account for issues of completeness and interpretation if only part of the material is used. We also strongly suggest users give proper credit/citation to this presentation and its author.



FEMA



Building Seismic
Safety Council



Chapter 4 Reinforced Concrete Ductile Coupled Shear Walls

2020 NEHRP Provisions Training Materials

S. K. Ghosh and Prabuddha Dasgupta, S. K. Ghosh Associates LLC



FEMA



Building Seismic
Safety Council

BSSC



Coupled Walls

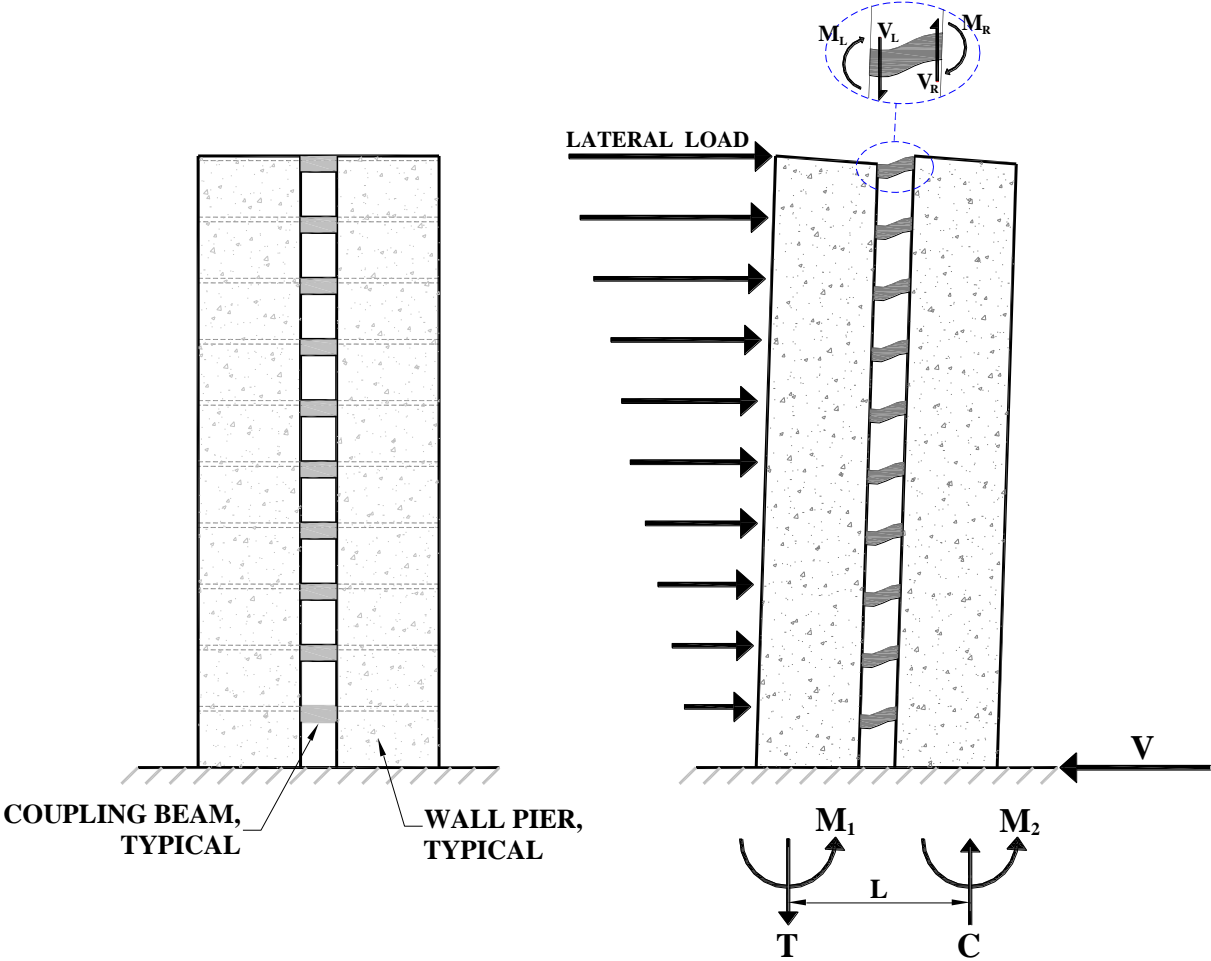

FEMA



Building Seismic Safety Council



Coupled Walls

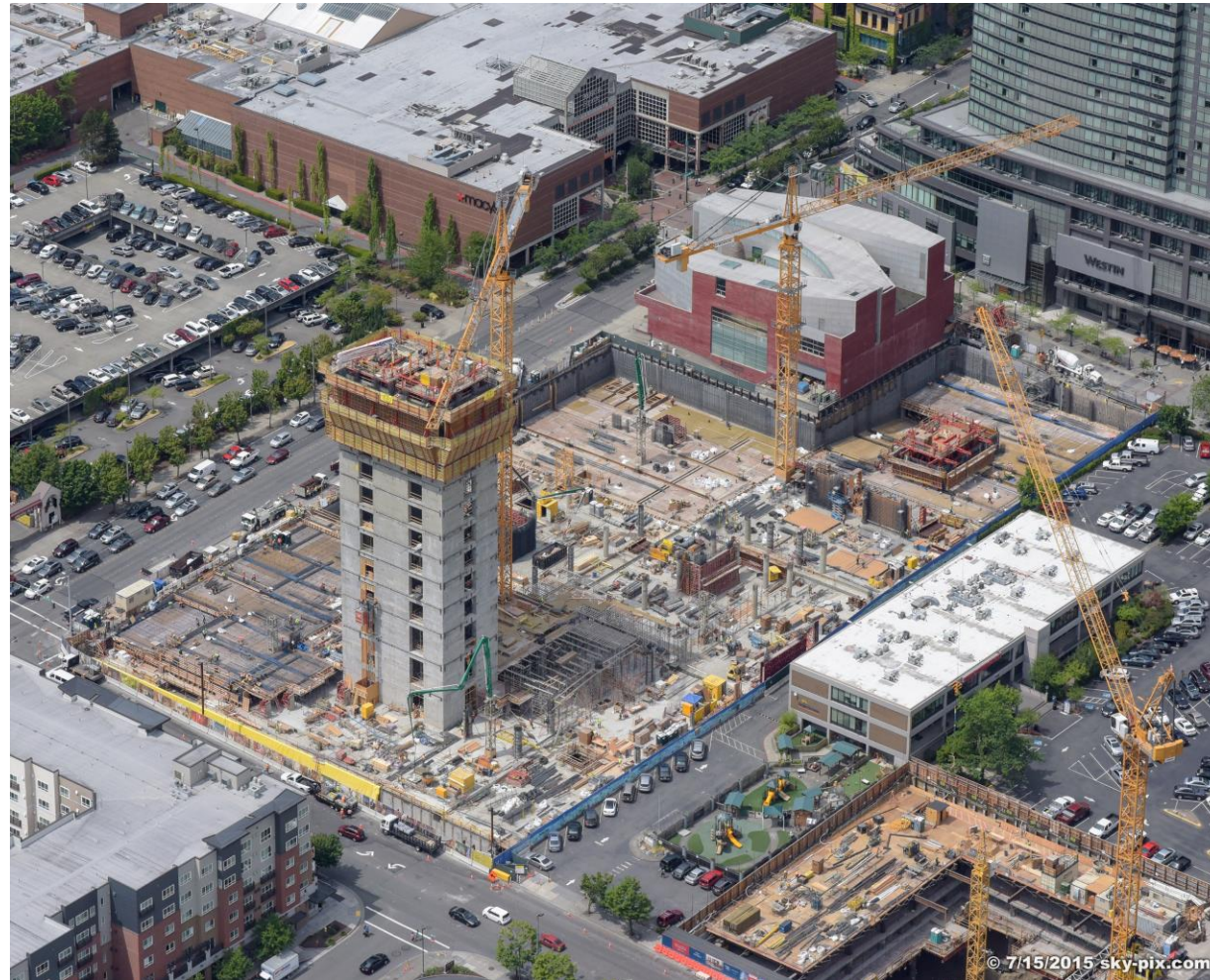

Courtesy: Cary
Kopczynski & Company,
Bellevue, WA



FEMA



Building Seismic
Safety Council



Coupled Walls



Courtesy: Cary
Kopczynski & Company,
Bellevue, WA



FEMA



Building Seismic
Safety Council



Coupled Walls



FEMA



Building Seismic
Safety Council



Coupled Walls

Coupled shear wall systems are recognized as distinct from isolated shear wall systems in Canadian and New Zealand codes; they are also accorded higher response modification factors in view of their superior seismic performance. ASCE/SEI 7, prior to its 2022 edition, made no such distinction.



FEMA



Building Seismic
Safety Council



Ductile Coupled Shear Walls

Bertero wrote in 1977: “Use of coupled walls in seismic-resistant design seems to have great potential. To realize this potential it would be necessary to prove that it is possible to design and construct “ductile coupling girders” and “ductile walls” that can SUPPLY the required strength, stiffness, and stability and dissipate significant amounts of energy through stable hysteretic behavior of their critical regions.”

Thus, discussion needs to focus not on just coupled walls, but **ductile coupled walls** consisting of **ductile shear walls** and **ductile coupling beams**.



FEMA



Building Seismic
Safety Council



Energy Dissipation in Coupling Beams

MKA Study:

Non-linear response history analyses were conducted using spectrally matched ground motion records on a variety of coupled shear wall archetypes. Archetypes ranged from 5 to 50 stories in height and contained a range of longitudinal reinforcement ratios in the coupling beams as well as the shear walls.



FEMA



Building Seismic
Safety Council



Energy Dissipation in Coupling Beams

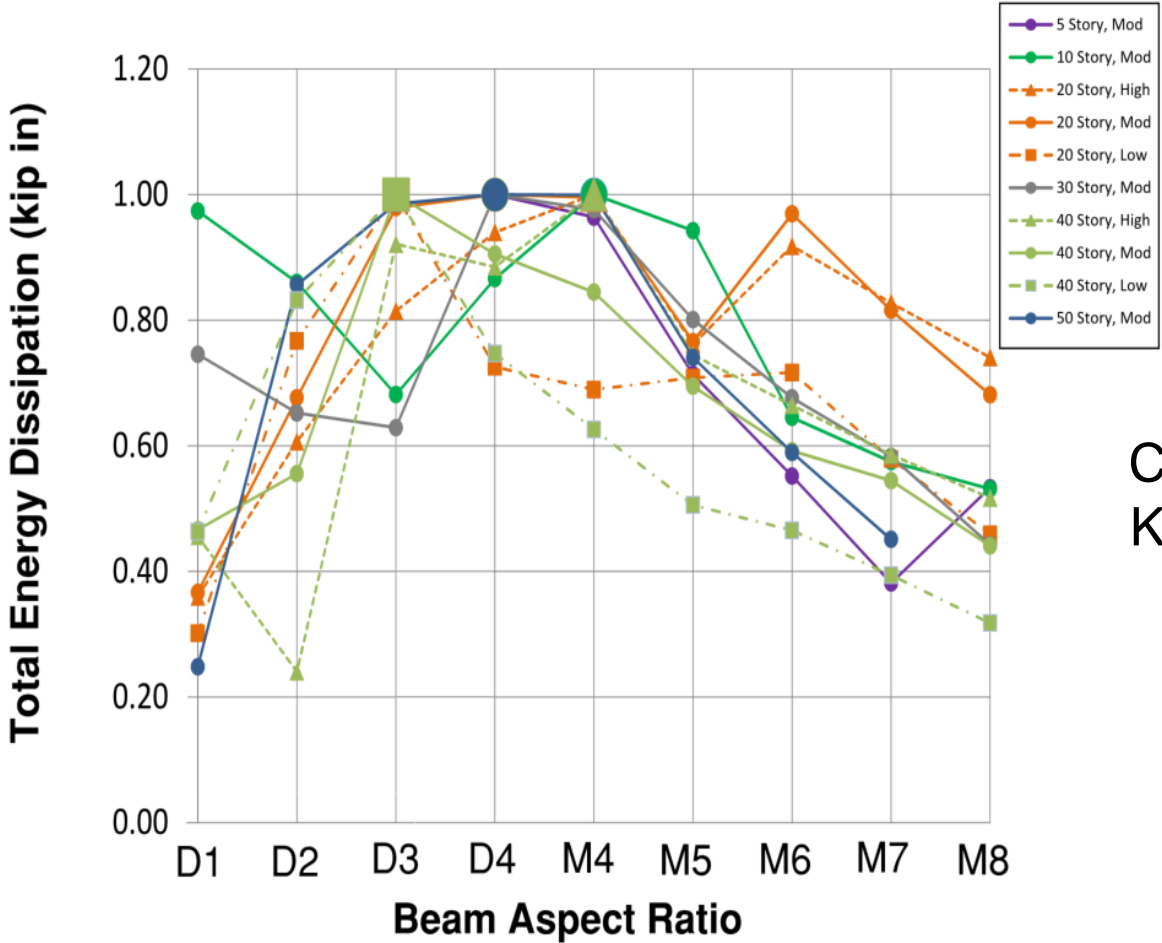

Courtesy: Magnusson Klemencic Associates



FEMA

Building Seismic Safety Council



ACI 318-19 18.10.9 Ductile Coupled Walls

18.10.9.1 Ductile coupled walls shall satisfy the requirements of this section.

18.10.9.2 Individual walls shall satisfy $h_{wcs}/\ell_w \geq 2$ and the applicable provisions of 18.10 for special structural walls.

18.10.9.3 Coupling beams shall satisfy 18.10.7 [Coupling beams] and (a) through (c) in the direction considered.

(a) Coupling beams shall have $\ell_n/h \geq 2$ at all levels of the building.

(b) All coupling beams at a floor level shall have $\ell_n/h \leq 5$ in at least 90 percent of the levels of the building.

(c) The requirements of 18.10.2.5 shall be satisfied at both ends of coupling beams [reinforcement developed for $1.25f_y$].



FEMA



Building Seismic
Safety Council



Special Shear Walls

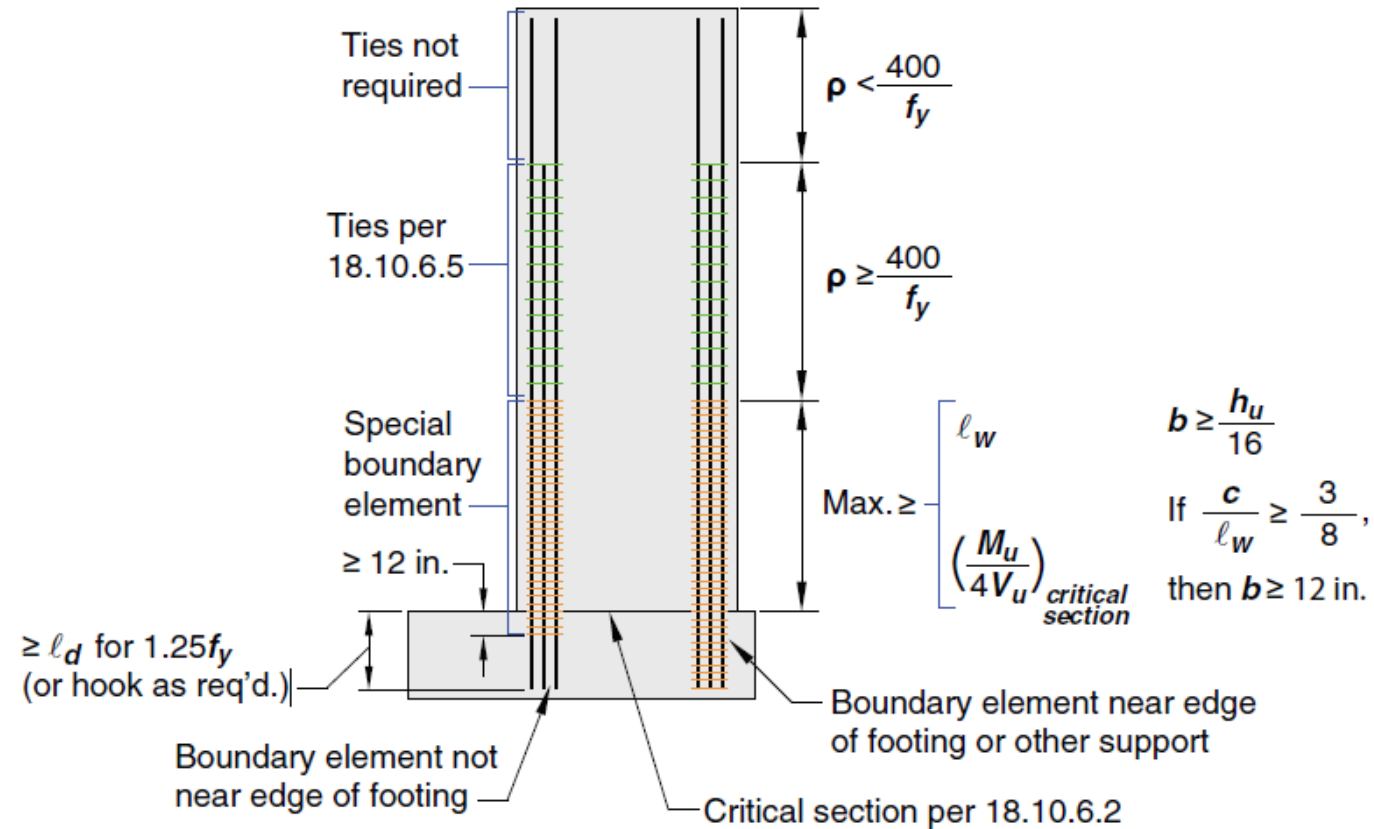

(a) Wall with $h_w/l_w \geq 2.0$ and a single critical section controlled by flexure and axial load designed using 18.10.6.2, 18.10.6.4, and 18.10.6.5



FEMA



Building Seismic Safety Council



Ductile Coupling Beams

- Aspect ratio $l_n/h \geq 4$
 - Satisfy requirements of 18.6
- Aspect ratio $l_n/h < 4$
 - Permitted to be reinforced with two intersecting groups of diagonal bars
- Aspect ratio $l_n/h < 2$ and $V_u > 4\sqrt{f'_c}A_{cw}$
 - Must be reinforced with two intersecting groups of diagonal bars



FEMA



Building Seismic
Safety Council



Ductile Coupling Beams

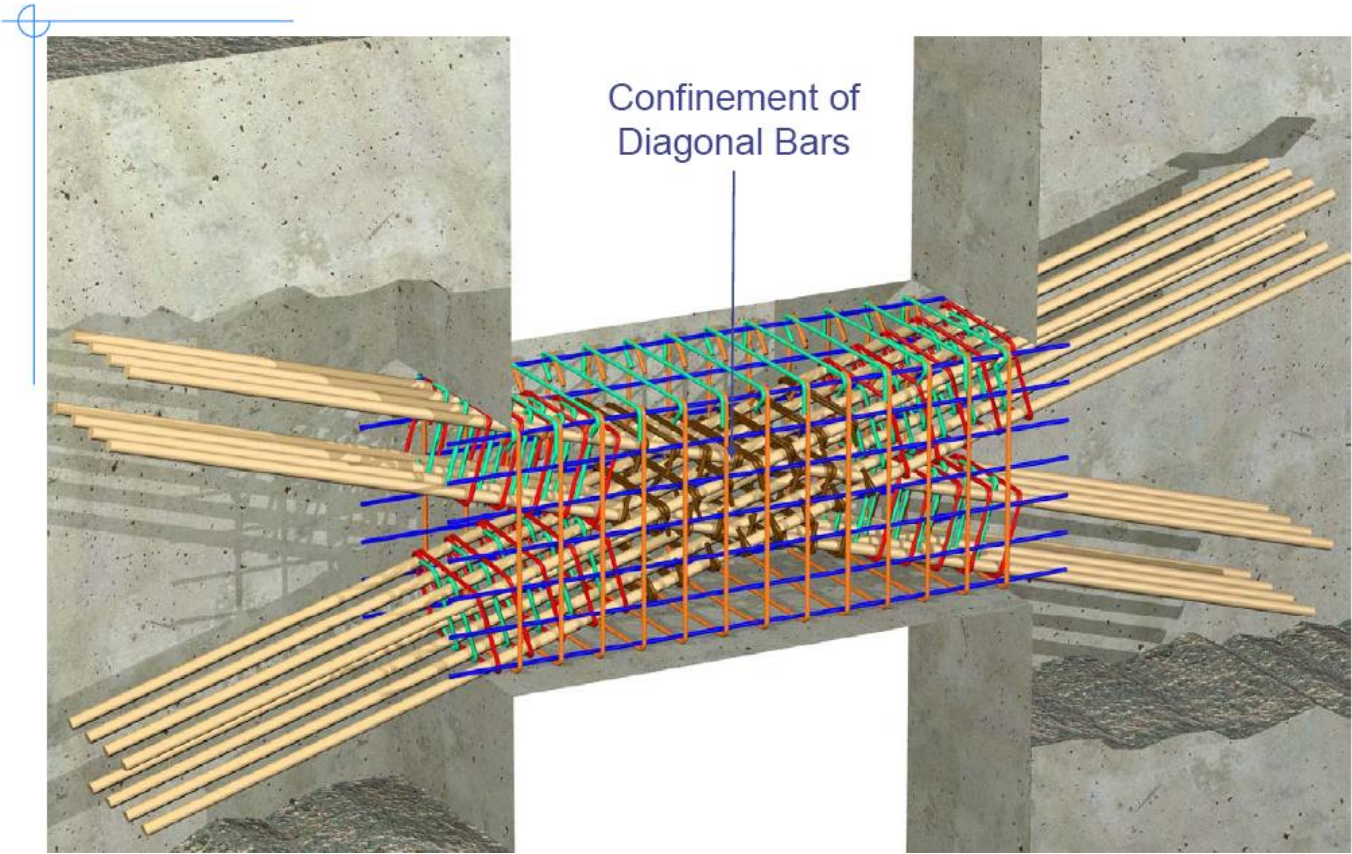

Source: <http://nees.seas.ucla.edu/pankow>



FEMA



Building Seismic
Safety Council



Ductile Coupling Beams

ACI 318-08 Alternate Detail

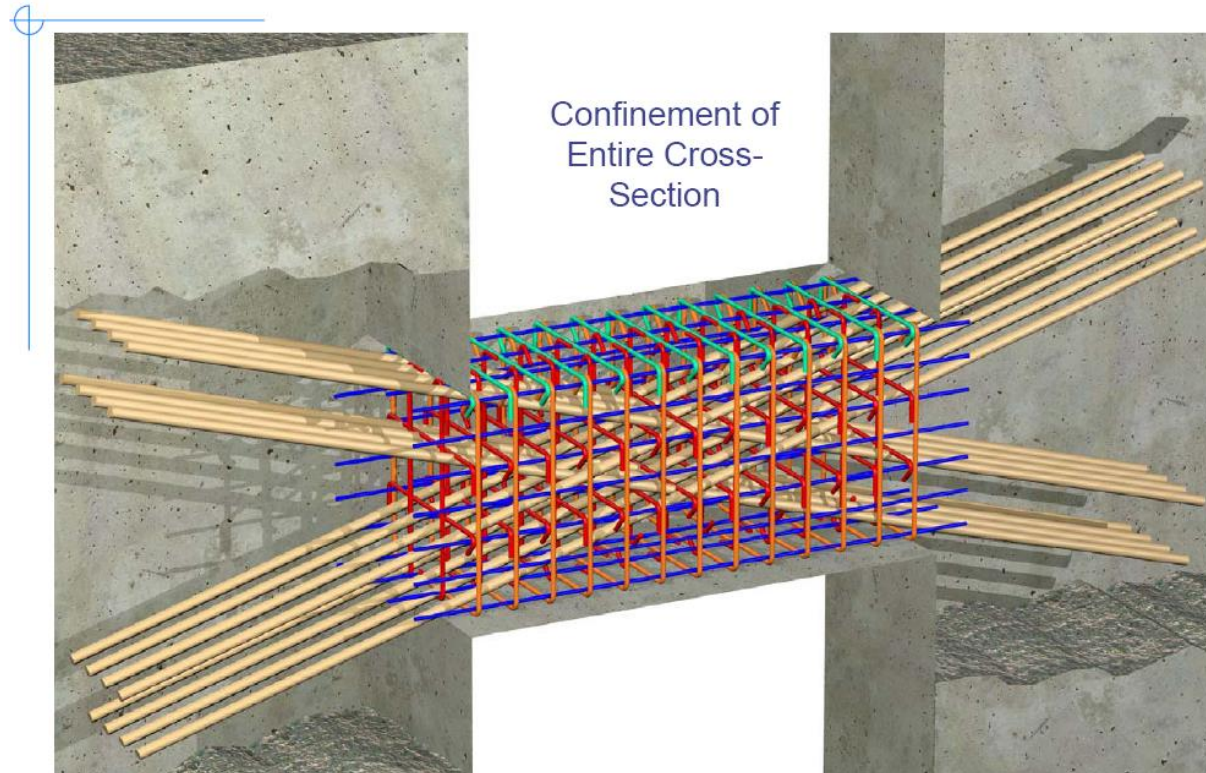

Source: <http://nees.seas.ucla.edu/pankow>



FEMA



Building Seismic
Safety Council



2020 NEHRP Provisions

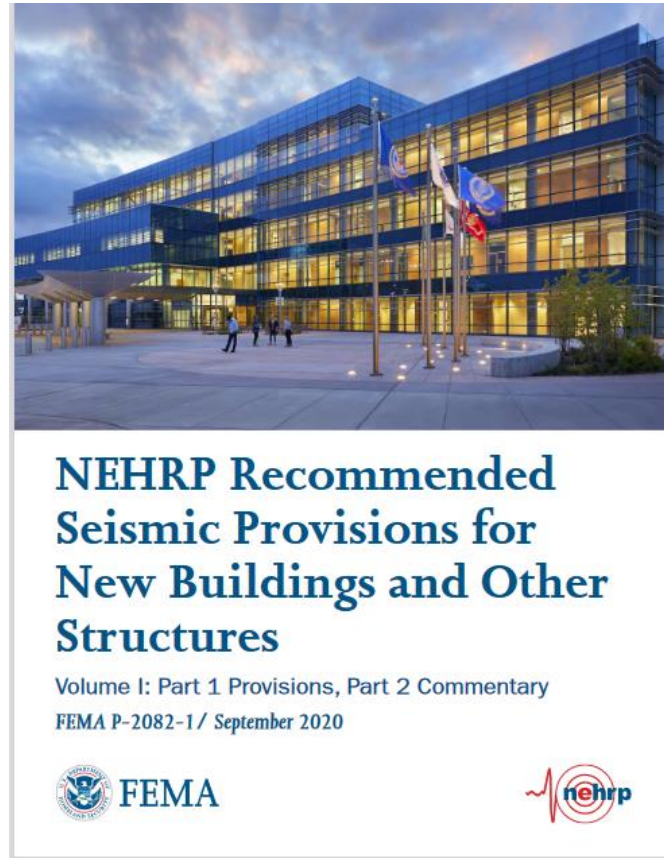

FEMA



Building Seismic
Safety Council



2020 NEHRP Provisions

- Part 1: Modifications to ASCE/SEI 7-16
- Part 2: Commentary to the Modifications
- Part 3: Resource Papers



FEMA



Building Seismic
Safety Council



P695 Study

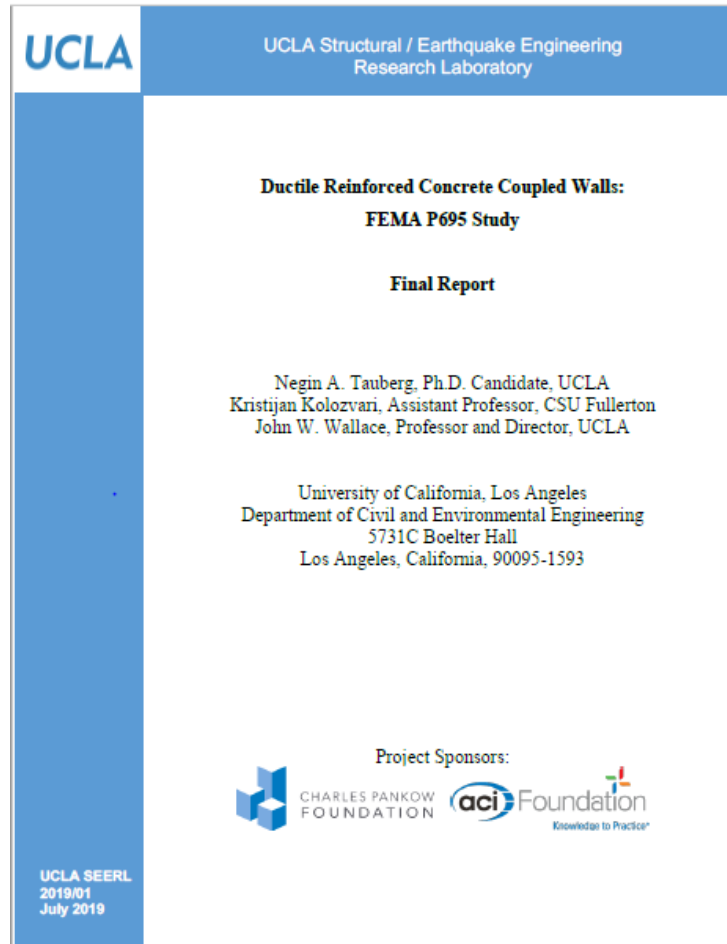

FEMA



Building Seismic
Safety Council



Additional ACI 318-19 Changes in Special Shear Wall Design

There have been four significant ACI 318-19 code changes, all adopted in our FEMA P695 study, to address the flexural-compression wall failure issue.

- (1) **18.10.3.1** (shear amplification) - would typically require design shear (required shear strength) V_u to be amplified by a factor of up to 3 (similar to New Zealand, Canada).
- (2) **18.10.6.4** - requires improved wall boundary and wall web detailing, i.e, overlapping hoops if the boundary zone dimensions exceed 2:1, crossties with 135-135 hooks on both ends, and 135-135 crossties on web vertical bars.



FEMA



Building Seismic
Safety Council



Additional ACI 318-19 Changes in Special Shear Wall Design

- (3) **18.10.6.2(b)** (Wall drift or deformation capacity check) - requires a low probability of lateral strength loss at MCE level hazard (you can think of it as requiring a minimum wall compression zone thickness), and
- (4) **18.10.2.4** - Minimum wall boundary longitudinal reinforcement, to limit the potential of brittle tension failures for walls that are lightly-reinforced.



FEMA



Building Seismic
Safety Council



Shear Amplification: Concrete Shear Walls

18.10.3.1 The design shear force V_e shall be calculated by:

$$V_e = \Omega_v \omega_v V_u \leq 3 V_u \quad (18.10.3.1)$$

where V_u , Ω_v , and ω_v are defined in 18.10.3.1.1, 18.10.3.1.2, and 18.10.3.1.3, respectively.

18.10.3.1.1 V_u is the shear force obtained from code lateral load analysis with factored load combinations.



FEMA



Building Seismic
Safety Council



Shear Amplification: Concrete Shear Walls

18.10.3.1.2 Ω_v shall be in accordance with Table 18.10.3.1.2.

Table 18.10.3.1.2—Overstrength factor Ω_v at critical section

Condition	Ω_v	
$h_{wcs}/\ell_w > 1.5$	Greater of	M_{pr}/M_u ^[1]
		1.5 ^[2]
$h_{wcs}/\ell_w \leq 1.5$	1.0	

^[1] For the load combination producing the largest value of Ω_v .

^[2] Unless a more detailed analysis demonstrated a smaller value, but not less than 1.0.



Shear Amplification: Concrete Shear Walls

18.10.3.1.3 For walls with $h_{wcs}/\ell_w < 2.0$, ω_v shall be taken as 1.0. Otherwise, ω_v shall be calculated as:

$$\omega_v = 0.9 + \frac{n_s}{10} \quad n_s \leq 6 \quad (18.10.3.1.3)$$

$$\omega_v = 1.3 + \frac{n_s}{30} \leq 1.8 \quad n_s > 6$$

where n_s shall not be taken less than the quantity $0.007h_{wcs}$.



FEMA



Building Seismic
Safety Council



Earthquake Force-Resisting Structural Systems of Concrete — ASCE/SEI 7-22

Basic Seismic Force-resisting System	Detailing Reference Section	R	Ω_0	C_d	System Limitations And Building Height Limitations (Ft) By Seismic Design Category				
					B	C	D	E	F
A. Bearing Wall System									
1. Special reinforced concrete shear walls	14.2	5	$2\frac{1}{2}$	5	NL	NL	160	160	100
2. Ductile Coupled reinforced concrete shear walls^q	<u>14.2</u>	<u>8</u>	<u>$2\frac{1}{2}$</u>	<u>8</u>	<u>NL</u>	<u>NL</u>	<u>160</u>	<u>160</u>	<u>100</u>
3. Ordinary reinforced concrete shear walls	14.2	4	$2\frac{1}{2}$	4	NL	NL	NP	NP	NP

^q Structural height, h_n , shall not be less than 60 ft (18.3 m).

Minimum height is intended to ensure adequate degree of coupling and significant energy dissipation provided by the coupling beams.



FEMA



Building Seismic Safety Council



Earthquake Force-Resisting Structural Systems of Concrete — ASCE/SEI 7-22

Basic Seismic Force-resisting System	Detailing Reference Section	R	Ω_0	C_d	System Limitations And Building Height Limitations (Ft) By Seismic Design Category				
					B	C	D	E	F
B. Building Frame System									
4. Special reinforced concrete shear walls	14.2	6	2 ^{1/2}	5	NL	NL	160	160	100
5. <u>Ductile Coupled reinforced concrete shear walls^q</u>	<u>14.2</u>	<u>8</u>	<u>2^{1/2}</u>	<u>8</u>	<u>NL</u>	<u>NL</u>	<u>160</u>	<u>160</u>	<u>100</u>
6. Ordinary reinforced concrete shear walls	14.2	5	2 ^{1/2}	4 ^{1/2}	NL	NL	NP	NP	NP

^q Structural height, h_n , shall not be less than 60 ft (18.3 m).



FEMA



Building Seismic Safety Council



Earthquake Force-Resisting Structural Systems of Concrete — ASCE/SEI 7-22

Basic Seismic Force-resisting System	Detailing Reference Section	R	Ω_0	C_d	System Limitations And Building Height Limitations (Ft) By Seismic Design Category				
					B	C	D	E	F
D. Dual Systems with Special Moment Frames									
3. Special reinforced concrete shear walls	14.2	7	2 ^{1/2}	5 ^{1/2}	NL	NL	NL	NL	NL
4. Ductile Coupled reinforced concrete shear walls^q	<u>14.2</u>	<u>8</u>	<u>2^{1/2}</u>	<u>8</u>	<u>NL</u>	<u>NL</u>	<u>NL</u>	<u>NL</u>	<u>NL</u>
5. Ordinary reinforced concrete shear walls	14.2	6	2 ^{1/2}	5	NL	NL	NP	NP	NP

^q Structural height, h_n , shall not be less than 60 ft (18.3 m).



FEMA



Building Seismic Safety Council



Example Problem

Design of a Special Reinforced
Concrete Ductile Coupled Wall



FEMA



Building Seismic
Safety Council



Federal Emergency Management Agency

26

Introduction

A 22-story reinforced concrete residential building is designed following the requirements of ASCE/SEI 7-22, and ACI 318-19. The building consists of a flat plate-column gravity system with a central core, formed by four reinforced concrete coupled structural walls, which acts as the seismic force-resisting system. The structural walls are designed as Ductile Coupled Reinforced Concrete Shear (Structural) Walls.

A computer rendering of the building framing is shown on the next two slides. The plan view of the building changes from one floor to another. A plan view of the second floor of the building is shown.



FEMA



Building Seismic
Safety Council



Example Building Configuration

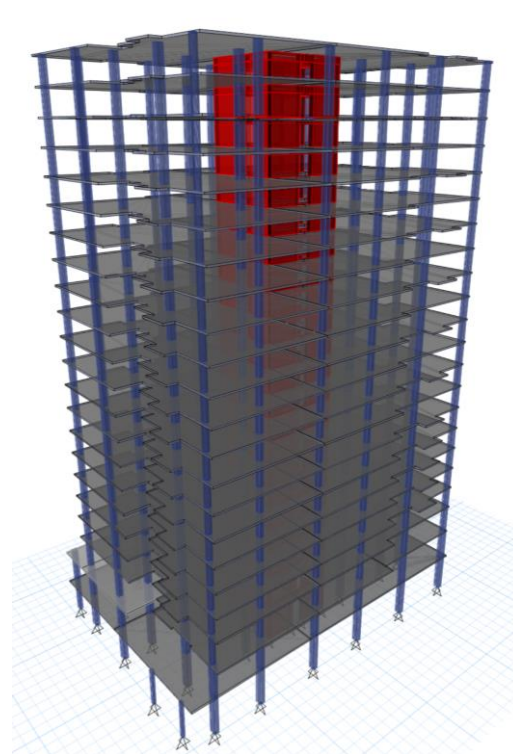

3D View



FEMA



Building Seismic
Safety Council



Example Building Configuration

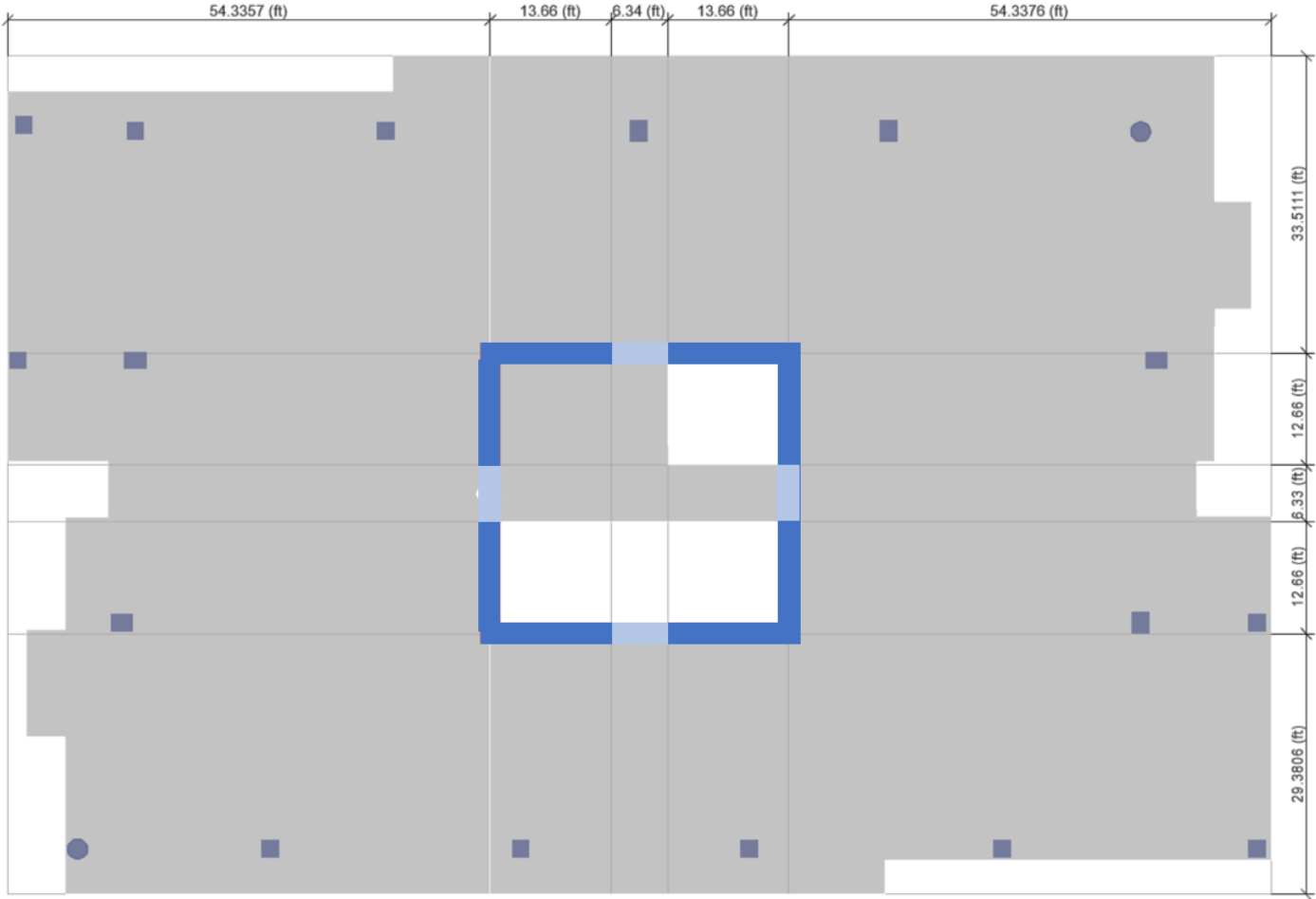

Second Floor Plan View



FEMA

Building Seismic Safety Council



Design Criteria

- Member Sizes:
 - Shear walls: 26 in. thick
 - Slabs (2nd and 3rd floors): 8 in. thick
(4th floor and higher): 7.5 in. thick
 - Gravity columns: Various sizes
- Material properties:
 - Concrete (used in structural walls and columns): $f_c' = 8000$ psi (all floors)
 - Concrete (used in slabs): $f_c' = 6000$ psi (floors)
 - All members are constructed of normal weight concrete ($w_c = 150$ pcf)
 - Reinforcement (used in all structural members): $f_y = 60,000$ psi



FEMA



Building Seismic
Safety Council



Design Criteria

- Service Loads:
 - Superimposed dead load: 25 psf (includes SDL on the floor plus the weight of cladding distributed over the floor slab.)
 - Live load: Based on the 40 psf live load prescribed in ASCE/SEI 7-22 Table 4.3-1 for residential buildings (private rooms and corridors serving them), a reduced live load of 20 psf is used in the example.
 - Reduced roof Live load: 20 psf
- Seismic Design Data:
 - Risk Category: II
 - Seismic importance factor, $I_e = 1.0$
 - Site Class: D



FEMA



Building Seismic
Safety Council



Design Criteria

- Seismic Design Data (contd.):
 - The maximum considered earthquake spectral response acceleration:
At short periods, $S_S = 1.65g$, and
At 1-sec period, $S_1 = 0.65g$.
 - The maximum considered earthquake spectral response acceleration (site modified):
At short periods, $S_{MS} = 1.65g$, and
At 1-sec period, $S_{M1} = 0.98g$.
 - Design Spectral Response Acceleration Parameters (at 5% damping):
At short periods: $S_{DS} = 2/3 S_{MS}/g = 2/3 \times 1.65 = 1.10$
At 1-sec period: $S_{D1} = 2/3 S_{M1}/g = 2/3 \times 0.98 = 0.65$



FEMA



Building Seismic
Safety Council



Design Criteria

- Seismic Design Data (contd.):
 - Long-period transition period, $T_L = 8$ sec
 - Ductile Coupled Reinforced Concrete Structural Walls ... $R = 8$; $C_d = 8.0$, $\Omega_0 = 2.5$ (ASCE/SEI 7-22 Table 12.2-1)
 - Seismic Design Category: Based on both S_{DS} (ASCE/SEI 7-22 Table 11.6-1) and S_{D1} (ASCE/SEI 7-22 Table 11.6-2), the Seismic Design Category (SDC) for the example building is D.



FEMA



Building Seismic
Safety Council



Design Procedure

Although ASCE/SEI 7-22 permits the Equivalent Lateral Force procedure to be used in all situations, the modal response spectrum analysis (MRSA) procedure (ASCE/SEI 7-22 Section 12.9.1) is used in this example. However, as part of the MRSA procedure, base shear is also determined using Equivalent Lateral Force (ELF) procedure. This is because ASCE/SEI 7-22 requires that the base shear obtained from MRSA be scaled up to match the ELF base shear.

The building was modeled in ETABS 2016, and the total seismic weight was obtained from the program as **43,099 kips**.



FEMA



Building Seismic
Safety Council



Analysis by Equivalent Lateral Force Procedure

- Structural period calculation
 - Coefficient, $C_t = 0.02$ [ASCE/SEI 7-22 Table 12.8-2]
 - Coefficient, $\alpha = 0.75$ [ASCE/SEI 7-22 Table 12.8-2]
 - Structure height above base, $h_n = 234.25$ ft
 - Approximate period, $T_a = 0.02h_n^\alpha = 0.02 \times 234.25^{0.75} = 1.2$ sec.
 - Fundamental period from modal analysis by ETABS, $T = 2.58$ sec (along x-axis)
 - Fundamental period from modal analysis by ETABS, $T = 2.26$ sec (along y-axis)
 - Calculated period is larger than the approximate period. However, the fundamental period cannot exceed $C_u T_a$.
 - For $S_{D1} = 0.65$, $C_u = 1.4 \rightarrow C_u T_a = 1.4 \times 1.2 = 1.68$ sec $\rightarrow T$ used in design = 1.68 sec $< T_L (= 8$ sec)



Analysis by Equivalent Lateral Force Procedure

- Base shear calculation

- $C_S = S_{DS}I_e/R = 1.101 \times 1.0/8 = 0.138$ (ASCE/SEI 7-22 Eq. 12.8-2)

- $C_S \leq S_{DS}I_e/RT = 0.65 \times 1.0 / (8 \times 1.68) = 0.048$ (for $T \leq T_L$) (ASCE/SEI 7-22 Eq. 12.8-3)

- $C_S \geq 0.044S_{DS}I_e = 0.044 \times 0.65 \times 1.0 = 0.029$ (ASCE/SEI 7-22 Eq. 12.8-5)

- $C_S \geq 0.01$ (ASCE/SEI 7-22 Eq. 12.8-5)

- $C_S \leq 0.5S_1I_e/R = 0.5 \times 0.65 \times 1.0 / 8 = 0.041$ (for $S_1 \leq 0.6g$) (ASCE/SEI 7-22 Eq. 12.8-6)

- Governing $C_S = 0.048$

- Base shear, $V = C_S \times W = 0.048 \times 43,099 = 2090$ kips



Modal Response Spectrum Analysis

A 3-D modal response spectrum analysis (MRSA) is performed using ETABS (v2016).

- Semi-rigid diaphragms are assigned at each level.
- The effective cracked member stiffnesses used in the analyses are as follows:
 - Columns and shear walls, $I_{eff} = 0.7I_g$
 - Coupling beams, $I_{eff} = 0.25I_g$
 - Gravity columns, $I_{eff} = 0.1I_g$ (with pinned connections at the base)
- Adequate number of modes are considered in the modal analysis to incorporate **100%** of the modal mass in each of x- and y-directions. Also, appropriate scale factors are applied to the base shears calculated in the x- and y-directions to amplify them to those calculated in the ELF procedure.



FEMA



Building Seismic
Safety Council



Floor Forces from MRSA

Story	Elevation (ft)	X-Dir (kip)	Y-Dir (kip)
L23	234.25	195.35	195.35
L22	224.25	206.00	206.00
L21	214.25	192.84	192.84
L20	204.25	177.63	177.63
L19	194.25	165.00	165.00
L18	184.25	150.81	150.81
L17	174.25	138.90	138.90
L16	164.25	125.66	125.66
L15	154.25	114.43	114.43
L14	144.25	102.24	102.24
L13	134.25	91.78	91.78

Story	Elevation (ft)	X-Dir (kip)	Y-Dir (kip)
L12	124.25	80.68	80.68
L11	114.25	71.00	71.00
L10	104.25	61.10	61.10
L09	94.25	52.34	52.34
L08	84.25	43.80	43.80
L07	74.25	35.84	35.84
L06	64.25	28.48	28.48
L05	54.25	21.77	21.77
L04	44.25	16.22	16.22
L03	31.25	12.95	12.95
L02	16.25	3.78	3.78



FEMA



Story Drifts from MRSA (X-Direction)

Story	Story Ht. (ft)	δ_{xe} (in.)	C_d	δ_x (in.)	Relative Drift (%)
L23	10	3.36	8	26.84	1.00
L22	10	3.21	8	25.65	1.02
L21	10	3.05	8	24.43	1.03
L20	10	2.90	8	23.18	1.05
L19	10	2.74	8	21.92	1.07
L18	10	2.58	8	20.64	1.08
L17	10	2.42	8	19.33	1.10
L16	10	2.25	8	18.02	1.10
L15	10	2.09	8	16.69	1.11
L14	10	1.92	8	15.36	1.11
L13	10	1.75	8	14.03	1.11

Story	Story Ht. (ft)	δ_{xe} (in.)	C_d	δ_x (in.)	Relative Drift (%)
L12	10	1.59	8	12.70	1.10
L11	10	1.42	8	11.38	1.09
L10	10	1.26	8	10.07	1.08
L09	10	1.10	8	8.77	1.06
L08	10	0.94	8	7.50	1.04
L07	10	0.78	8	6.25	1.00
L06	10	0.63	8	5.06	0.95
L05	10	0.49	8	3.91	0.89
L04	13	0.36	8	2.85	0.80
L03	15	0.20	8	1.60	0.59
L02	16.25	0.07	8	0.55	0.28



Story Drifts from MRSA (Y-Direction)

Story	Story Ht. (ft)	δ_{xe} (in.)	C_d	δ_x (in.)	Relative Drift (%)
L23	10	3.64	8	29.11	1.07
L22	10	3.48	8	27.83	1.09
L21	10	3.32	8	26.52	1.11
L20	10	3.15	8	25.19	1.13
L19	10	2.98	8	23.83	1.15
L18	10	2.81	8	22.45	1.17
L17	10	2.63	8	21.05	1.18
L16	10	2.45	8	19.63	1.19
L15	10	2.28	8	18.21	1.19
L14	10	2.10	8	16.77	1.20
L13	10	1.92	8	15.34	1.19

Story	Story Ht. (ft)	δ_{xe} (in.)	C_d	δ_x (in.)	Relative Drift (%)
L12	10	1.74	8	13.91	1.19
L11	10	1.56	8	12.48	1.18
L10	10	1.38	8	11.06	1.17
L09	10	1.21	8	9.65	1.15
L08	10	1.03	8	8.27	1.13
L07	10	0.86	8	6.92	1.09
L06	10	0.70	8	5.60	1.04
L05	10	0.54	8	4.35	0.98
L04	13	0.40	8	3.18	0.87
L03	15	0.23	8	1.82	0.67
L02	16.25	0.08	8	0.62	0.32



FEMA



Building Seismic Safety Council



Story Drift Limitation

According to ASCE/SEI 7-22 Section 12.12.1, the calculated relative story drift at any story must not exceed 2% (ASCE/SEI 7-22 Table 12.12-1 for all other buildings in Risk Category I and II). As can be seen from the previous slide, this is satisfied in all stories.



FEMA



Building Seismic
Safety Council



Design of Shear Wall

- The design of one of the shear walls at the base of the structure is illustrated in this example in accordance the provisions of ACI 318-19.
- One L-shaped segment of the shear wall core is designed as two flanged walls.
- Orthogonal combination of seismic forces is NOT required as axial loads on the wall from seismic forces are less than 20% of the design axial strength.

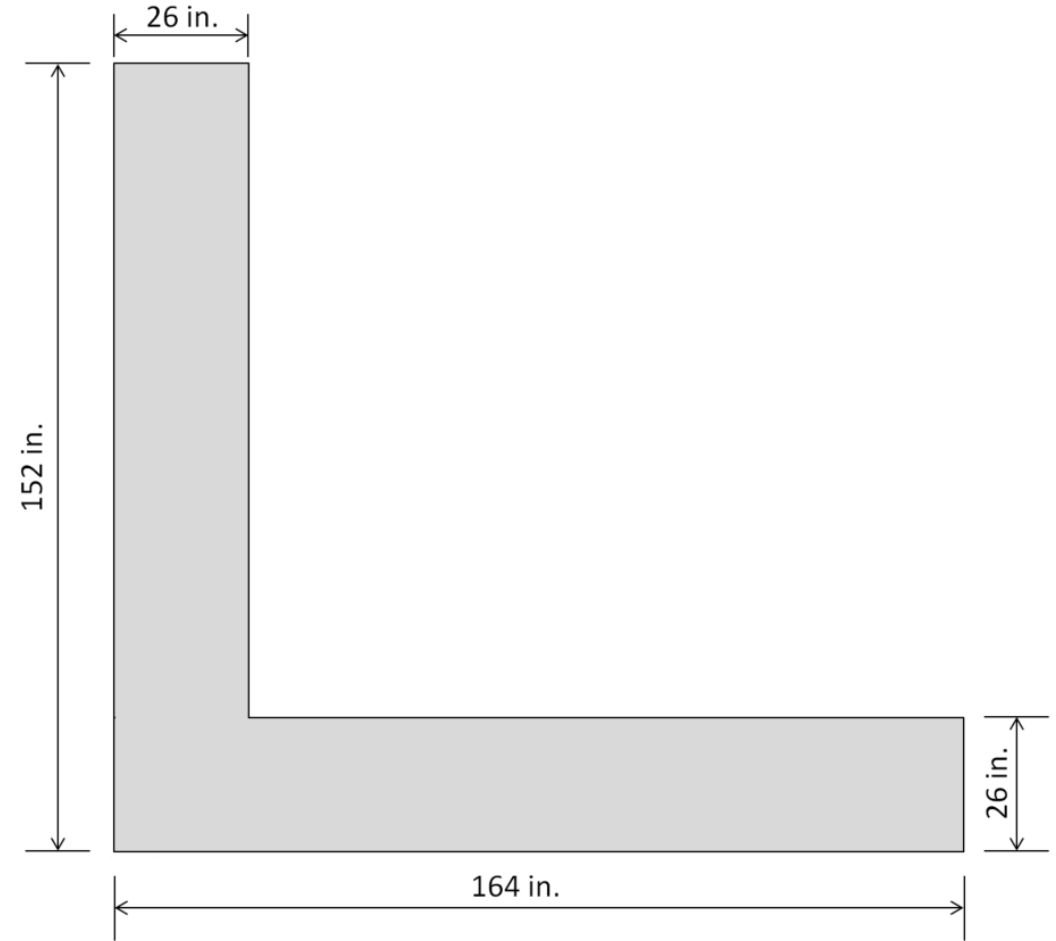

FEMA



Building Seismic
Safety Council



Design of Shear Wall – Design Loads

Seismic forces acting along x-axis are considered in this design example. The design calculations for the seismic forces acting along the y-axis are similar and are not shown. However, the final wall configuration will incorporate effects of seismic forces in both directions.

	Load Combinations	Axial Force, P_u (kips)	Shear Force, V_u (kips)	Bending Moment, M_u (ft-kips)
1	$1.4D$	6335	0	0
2	$1.2D + 1.6L + 0.5L_r$	6071	0	0
3	$(1.2+0.2S_{DS})D + \rho Q_E + 0.5L$	10,015	576	24,976
4	$(0.9D - 0.2S_{DS}D) + \rho Q_E$	6460	573	24,585
5	$(0.9D - 0.2S_{DS}D) - \rho Q_E$	-378	573	24,585



Design of Shear Wall – Design for Shear

- Height of the shear wall, $h_{wcs} = 2811$ in. (234.25 ft)
- Length of the shear wall, $\ell_w = 164$ in. (13.67 ft)
- $h_{wcs}/\ell_w = 2811/164 = 17.1$

ACI 318-19 (hereafter ACI 318) Section 18.10.2.2

At least two curtains of reinforcement shall be used if $V_u > 2A_{cv}\lambda\sqrt{f'_c}$ or $h_{wcs}/\ell_w \geq 2.0$. In this case, $h_{wcs}/\ell_w = 17.1 > 2.0$.

So, at least two curtains of reinforcement are required.



FEMA



Building Seismic
Safety Council



Design of Shear Wall – Design for Shear

ACI 318 Section 18.10.3.1

Design shear force, $V_e = \Omega_v \omega_v V_u \leq 3V_u$

- For walls with $h_{wcs}/l_w > 1.5$, Ω_v is the greater of M_{pr}/M_u and 1.5. The probable moment strength M_{pr} is unknown at this stage. So, it is assumed that $\Omega_v = 1.5$. This may very well prove to be unconservative. Once the flexural reinforcement has been provided, this will be verified or corrected, if necessary
- For walls with $h_{wcs}/l_w \geq 2.0$ and the number of stories above critical section, $n_s > 6$,
 $\omega_v = 1.3 + n_s/30 \leq 1.8$
 - In this example, $n_s = 22$. n_s cannot be taken less than the quantity $0.007h_{wcs}$ (= 19.68), which is satisfied.
 - $\omega_v = 1.3 + 22/30 = 2.03 \rightarrow \omega_v = 1.8$



FEMA



Building Seismic
Safety Council



Design of Shear Wall – Design for Shear

ACI 318 Section 18.10.3.1

Design shear force, $V_e = \Omega_v \omega_v V_u \leq 3V_u$

- $V_e = 1.5 \times 1.8 \times 576 = 1555$ kips (governs)
- $V_e = 3V_u = 3 \times 576 = 1728$ kips

ACI 318 Section 18.10.4.4.

The maximum nominal shear strength, V_n , allowed for a wall section is

$$10A_{cv}\sqrt{f'_c} = 10 \times 4264 \times \sqrt{f'_c} / 1000 = 3813 \text{ kips}$$

So, $\phi V_n = 0.75 \times 3813 = 2860$ kips $> V_e \rightarrow$ The provided wall section size is acceptable.



FEMA



Building Seismic
Safety Council



Design of Shear Wall – Design for Shear

ACI 318 Section 18.10.4.1

$$V_n = (\alpha_c \lambda \sqrt{f'_c} + \rho_t f_y) A_{cv} \geq V_e / \phi \quad (\text{ACI 318 Eq. 18.10.4.1})$$

- For $h_w / \ell_w = 17.1 \geq 2.0$, $\alpha_c = 2$
- For normal-weight concrete, $\lambda = 1$

Required horizontal shear reinforcement ratio:

$$\rho_t = \left[V_e / \phi A_{cv} - \alpha_c \lambda \sqrt{f'_c} \right] / f_y = 0.0051$$



FEMA



Building Seismic
Safety Council



Design of Shear Wall – Design for Shear

ACI 318 Section 18.10.4.1

- Two curtains of #7 horizontal shear reinforcement at a vertical spacing of 7 in. is adequate to resist this shear force. However, the 7” spacing is reduced to 5” in order to maintain uniformity with the reinforcement provided in the other leg of the shear wall to resist shear in y direction, leading to a provided $\rho_t = 0.009$. The 5” spacing also matches the vertical spacing of the transverse reinforcement provided in the special boundary element of the wall (shown later), which helps with construction efficiency.
- Per ACI 318 Section 18.10.2.1, the minimum $\rho_t = 0.0025$ and maximum reinforcement spacing = 18 in., both of which are satisfied.



FEMA



Building Seismic
Safety Council



Design of Shear Wall – Design for Shear

ACI 318 Section 18.10.4.3

$h_w/\ell_w > 2.0$. Therefore, ρ_ℓ need not be larger than or equal to ρ_t .

ACI 318 Section 18.10.2.1

Longitudinal reinforcement ratio:

- $\rho_\ell \geq 0.0025$ with a maximum spacing of 18 in.
- Provided two curtains of #8 vertical reinforcement at 14 in. spacing ($\rho_\ell = 0.004$). This will need to be increased in the end regions of the wall.



FEMA



Building Seismic
Safety Council



Design of Shear Wall – Design for Shear

ACI 318 Section 18.10.2.4

In walls with $h_w/\ell_w \geq 2.0$ that are effectively continuous from the base of the structure to the top of wall and are designed to have a single critical section for flexure and axial loads:

- longitudinal reinforcement ratio within $0.15\ell_w$ of the ends of the wall needs to be at least $6\sqrt{f'_c}/f_y$.

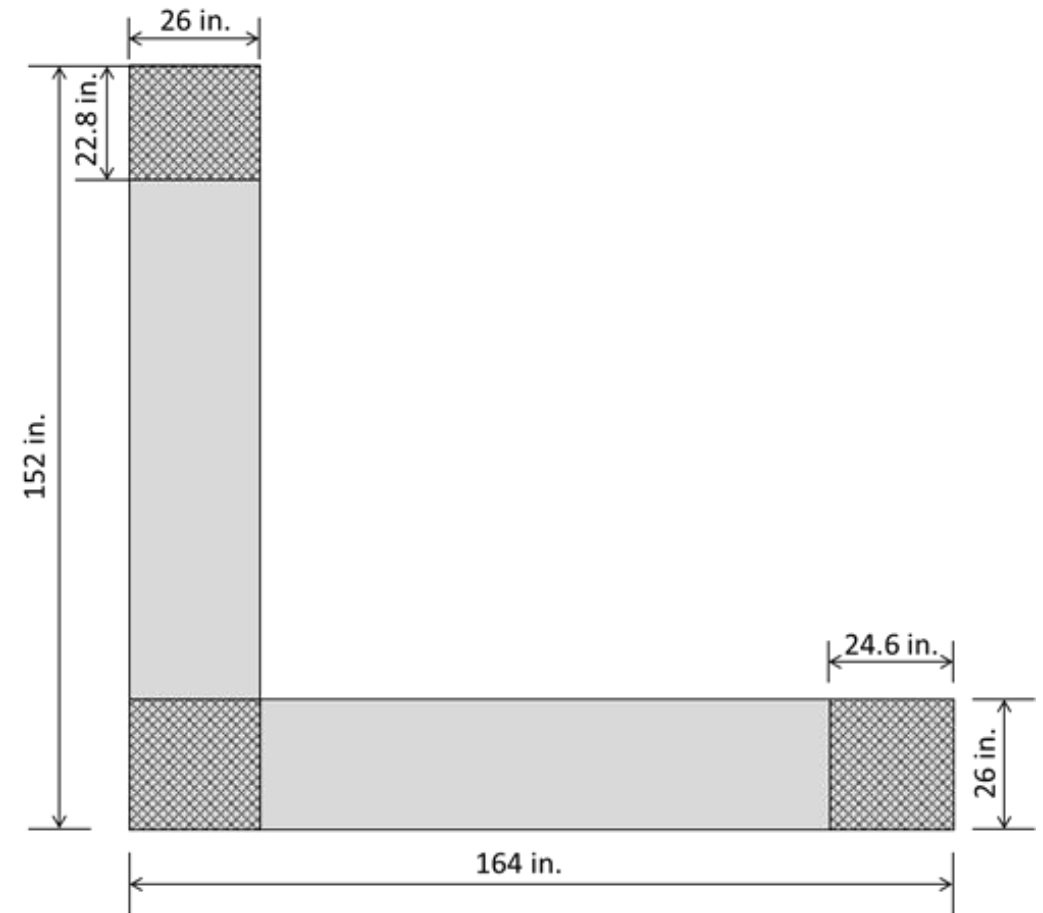

Design of Shear Wall – Design for Shear

ACI 318 Section 18.10.2.4

- 9 #8 bars are provided in a 3×3 pattern in the wall intersection area.

$$\rho_l = 0.01 > 6\sqrt{f'_c} / f_y (= 0.009) \dots\dots\dots\text{OK}$$

- This needs to be satisfied at the other ends of the two legs of the wall. However, reinforcement provided there would be governed by special boundary element requirements, which is shown next.

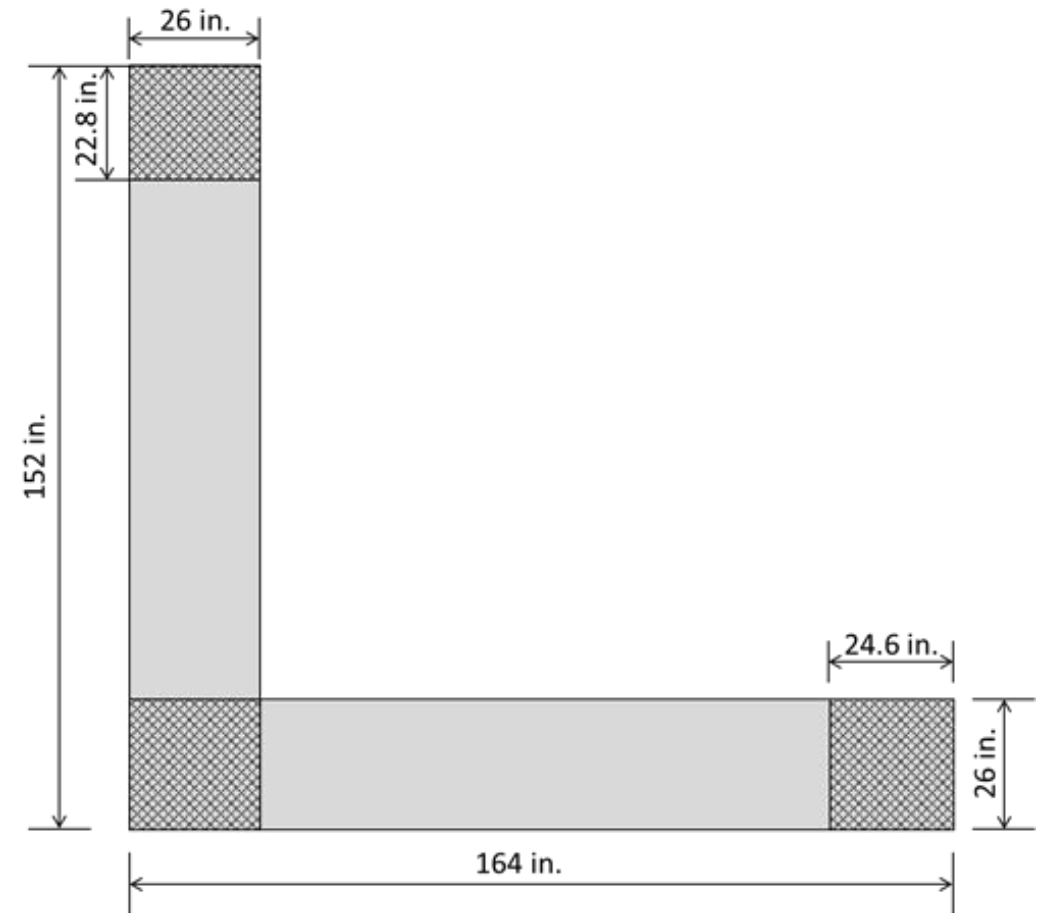

FEMA



Building Seismic Safety Council



Boundary Elements of Special RC Shear Walls

ACI 318 Section 18.10.6.1

The need for special boundary elements at the edges of shear walls is to be evaluated in accordance with ACI 318 Section 18.10.6.2 (displacement-based approach) or ACI 318 Section 18.10.6.3 (stress-based approach). In this example, the displacement-based approach is used as the wall satisfies the three required conditions:

- 1) $h_{wcs}/\ell_w \geq 2.0$,
- 2) The wall is continuous from the base of the structure to the top of the wall, and
- 3) The wall has a single critical section for bending and axial loads.



FEMA



Building Seismic
Safety Council



Boundary Elements of Special RC Shear Walls

ACI 318 Section 18.10.6.2(a): Displacement-based Approach

Compression zones are to be reinforced with special confinement reinforcement where:

$$1.5\delta_u/h_{wCS} \geq \ell_w/600c \quad (\text{ACI 318 Eq. 18.10.6.2a})$$

- δ_u is the design displacement. For seismic forces along the x-axis of the structure, δ_u was determined from the ETABS analysis as 26.84 in.
- c is the largest neutral axis depth of the wall cross-section calculated for the factored axial force and nominal moment strength consistent with the direction of the design displacement. This was determined using *spColumn* v7.00 as 95 in.



FEMA



Building Seismic
Safety Council



Boundary Elements of Special RC Shear Walls

ACI 318 Section 18.10.6.2(a): Displacement-based Approach

- The check was satisfied when the non-flanged end of the wall is in compression. Thus, a special boundary element is required at the non-flanged end.
- The same check was performed for the flanged end of the wall as well. However, when the flanged end of the wall is under compression, the neutral axis depth is small due to the presence of the flange, and as a result, the check is not satisfied. So, a special boundary element is not required for the flanged end of the wall.



FEMA



Building Seismic
Safety Council



Boundary Elements of Special RC Shear Walls

ACI 318 Section 18.10.6.2(b)(i): Height of special boundary element

The special boundary element reinforcement is to extend vertically from the critical section a distance not less than the larger of l_w and $M_u/4V_u$.

- $l_w = 164$ (13.67 ft) ... Governs
- $M_u/4V_u = 10.84$ ft

ACI 318 Section 18.10.6.2(b)(ii): Width of special boundary element

The width of boundary element, b (= 26 in.) $\geq \sqrt{0.025cl_w} = \sqrt{0.025 \times 95 \times 164} = 19.3$ in.

.....OK



Boundary Elements of Special RC Shear Walls

ACI 318 Section 18.10.6.4(a): Length of boundary element

Confined boundary element to extend horizontally from the extreme compression fiber a distance not less than the larger of $c - 0.1l_w$ and $c/2$.

- $c - 0.1l_w = 95 - 0.1 \times 164 = 78.6 \text{ in} \approx 80 \text{ in} \dots$ governs
- $c/2 = 95/2 = 47.5 \text{ in}.$

ACI 318 Section 18.10.6.4(b): Stability check for wall compression zone

Minimum width of the compression zone, $b = 26 \text{ in}.$ is required to be at least $h_u/16$, where h_u is the laterally unsupported height of the wall (18.10.6.4(b)).

- $h_u = \text{Story height} - \text{depth of coupling beam} = 158 \text{ in}.$
- $h_u/16 = 9.875 \text{ in} < 26 \text{ in} \dots \text{OK}$



FEMA



Building Seismic
Safety Council



Boundary Elements of Special RC Shear Walls

ACI 318 Section 18.10.6.4(c): Stability check for wall compression zone

For this wall,

- $h_{wcs}/\ell_w = 17.1 > 2.0$
- It is effectively continuous from the base of the structure to top of the wall
- It is designed to have a single critical section for flexure and axial loads.
- $c/\ell_w = 95/164 = 0.58 > 3/8$.

As a result, Section 18.10.6.4(c) requires the width of the flexural compression zone b over the length of 80 in. (calculated before) to be greater than or equal to 12 in. This is satisfied as the width of the wall is 26 in.



FEMA



Building Seismic
Safety Council



Boundary Elements of Special RC Shear Walls

ACI 318 Section 18.10.6.4(g): Minimum area of transverse reinforcement

$$A_{sh}/sb_c = \text{Greater of } \begin{cases} 0.3 \left(\frac{A_g}{A_{ch}} - 1 \right) \frac{f'_c}{f_{yt}} \\ 0.09 \frac{f'_c}{f_{yt}} \end{cases} \quad (\text{ACI 318 Table 18.10.6.4(g)})$$

Confinement perpendicular to the length of the wall:

$$A_{sh}/sb_c = \text{Greater of } \begin{cases} 0.3 \left(\frac{2080}{1771} - 1 \right) \frac{8}{60} \\ 0.09 \frac{8}{60} \end{cases} = 0.012$$

Provided 16 #5 bars in the form of hoops and cross-ties with a vertical spacing of 5 in.



FEMA



Building Seismic
Safety Council



Boundary Elements of Special RC Shear Walls

ACI 318 Section 18.10.6.4(g): Minimum area of transverse reinforcement

$$A_{sh}/sb_c = \text{Greater of } \begin{cases} 0.3 \left(\frac{A_g}{A_{ch}} - 1 \right) \frac{f'_c}{f_{yt}} \\ 0.09 \frac{f'_c}{f_{yt}} \end{cases} \quad (\text{ACI 318 Table 18.10.6.4(g)})$$

Confinement parallel to the length of the wall:

$$A_{sh}/sb_c = \text{Greater of } \begin{cases} 0.3 \left(\frac{2080}{1771} - 1 \right) \frac{8}{60} \\ 0.09 \frac{8}{60} \end{cases} = 0.012$$

Provided 5 #5 bars in the form of hoops and cross-ties with a vertical spacing of 5 in.



FEMA



Building Seismic
Safety Council



Boundary Elements of Special RC Shear Walls

ACI 318 Section 18.10.6.4(e): Vertical spacing of transverse reinforcement

According to ACI 318 Section 18.7.5.3, as revised by ACI 318 Section 18.10.6.4(e), the transverse reinforcement is to be vertically spaced at a distance not exceeding

- One-third of the least dimension of the boundary element = $23/3 = 7.67$ in.
- Six times the diameter of the smallest longitudinal reinforcement = $6 \times 1.0 = 6.0$ in.
..... Governs
- s_o , as defined by ACI 318 Eq. (18.7.5.3).

$$4 \text{ in.} \leq s_o = 4 + (14 - h_x)/3 \leq 6 \text{ in.} \rightarrow 4 \text{ in.} \leq s_o = 4 + (14 - 5.18)/3 \leq 6 \text{ in.} \rightarrow s_o = 6.0 \text{ in.}$$



FEMA



Building Seismic
Safety Council



Boundary Elements of Special RC Shear Walls

ACI 318 Section 18.10.6.4(e): Vertical spacing of transverse reinforcement

The vertical spacing also cannot exceed the maximum value given in ACI 318 Table 18.10.6.5(b). For Grade 60 reinforcement within the height of the special boundary element, it is the lesser of

- Six times the diameter of the smallest longitudinal reinforcement = $6 \times 1.0 = 6$ in.
- 6 in.

The provided spacing of 5 in. satisfies both these limits.



FEMA



Building Seismic
Safety Council



Boundary Elements of Special RC Shear Walls

ACI 318 Section 18.10.6.4(h): Concrete in floor system

Concrete within the thickness of the floor system at the special boundary element location is required to have a specified compressive strength of at least $0.7f'_c$. With the slab concrete strength of 6000 psi, this is satisfied.

ACI 318 Section 18.10.6.4(i and j)

The special boundary element confinement is to be provided at the non-flanged end of the wall at the base of the shear walls. The confinement needs to extend vertically by at least 12.67 ft above the base (ACI 318 Section 18.10.6.2(b)). Below the base, the boundary element transverse reinforcement needs to extend at least 12 in.



FEMA



Building Seismic
Safety Council



Boundary Elements of Special RC Shear Walls

ACI 318 Section 18.10.6.5: Boundary confinement where special boundary element is not required

- In this example, $V_u \geq \lambda \sqrt{f'_c} A_{cv}$. So, the end of the horizontal web reinforcement that terminates at the edges of wall flange is required to have a standard hook engaging the edge reinforcement. Alternatively, the edge reinforcement at the flange is required to be enclosed in U-stirrups having the same size and spacing as, and spliced to, the horizontal reinforcement. The first option is utilized for this example.
- In the intersection region of the wall, 9 #8 longitudinal bars are provided within an area of $26 \times 26 = 676 \text{ in.}^2$

$$\rho_\ell = 9 \times 0.79 / 676 = 0.0105 > 400/f_y = 400/60,000 = 0.0067$$

A vertical transverse reinforcement spacing of 5 in. is provided to match the spacing of the other transverse reinforcement for construction efficiency.



Design of Shear Wall (Grade 60 Reinforcement)

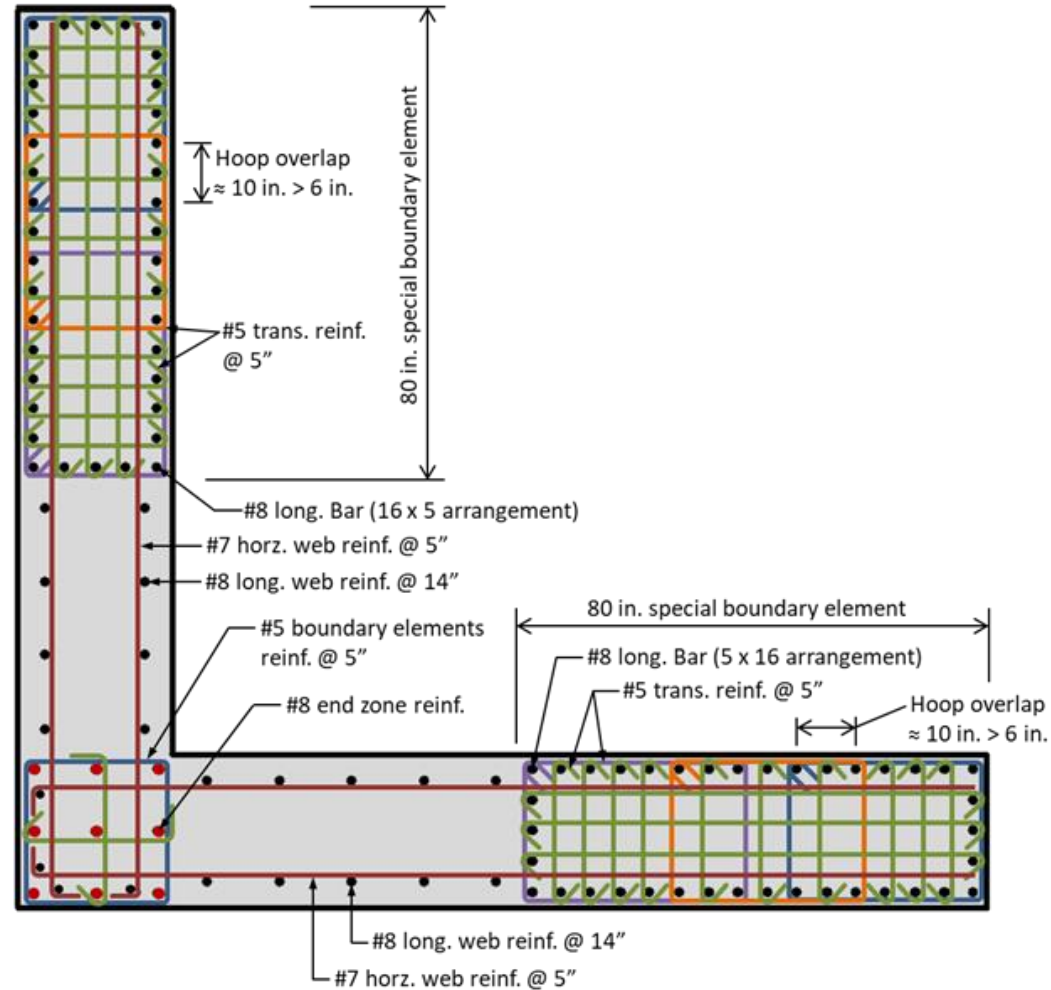

FEMA



Building Seismic Safety Council



Check Strength Under Flexure and Axial Loads

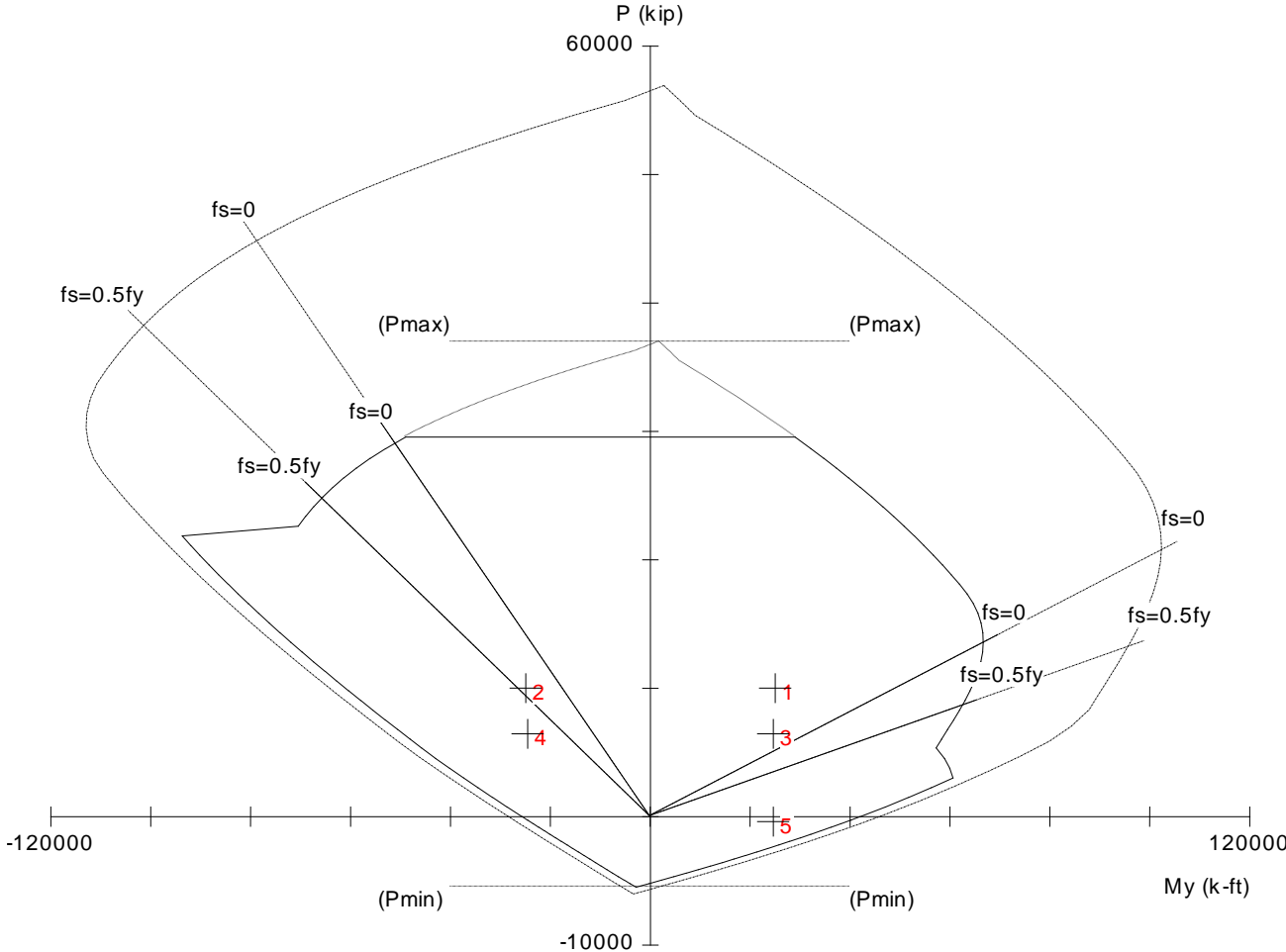

FEMA



Building Seismic Safety Council



Design of Shear Wall (Grade 80 Reinforcement)

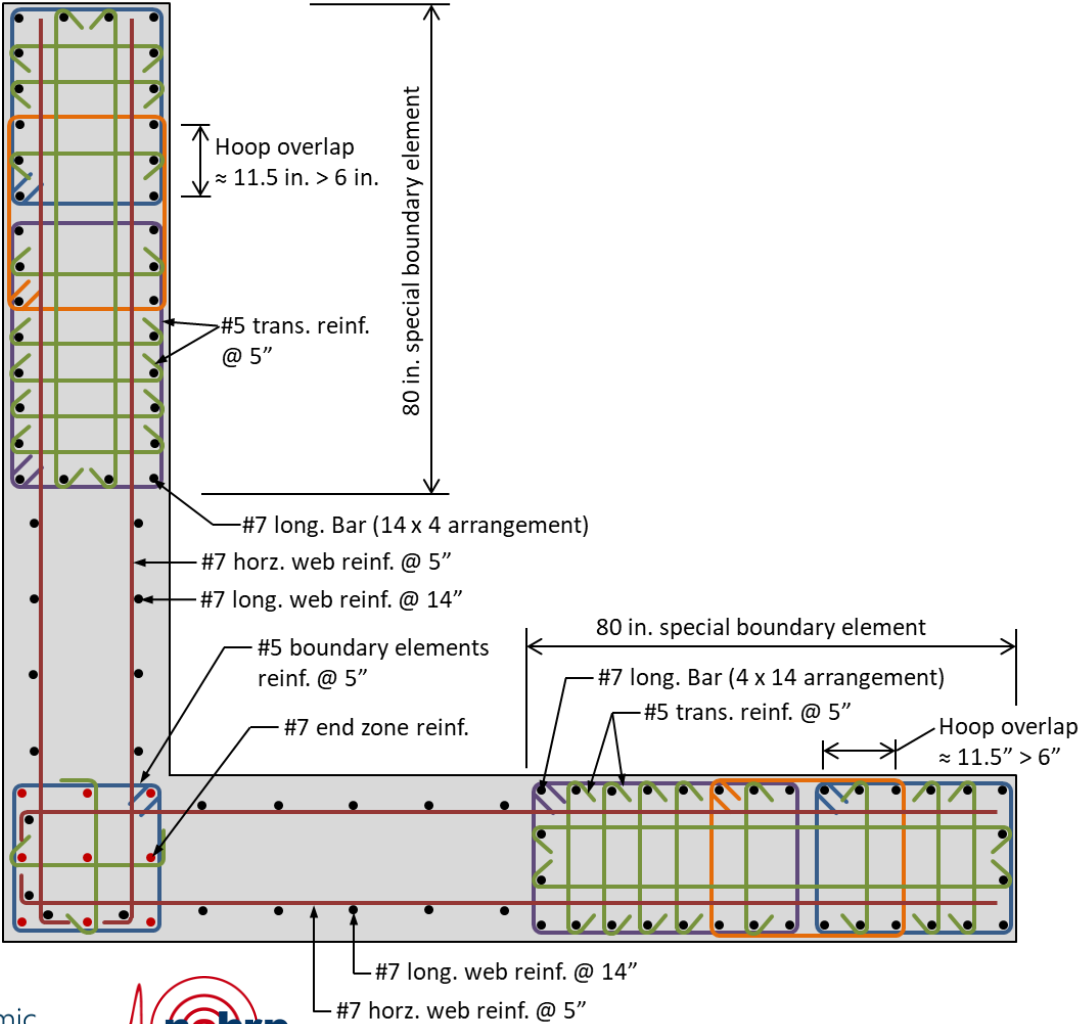

Design of Shear Wall (Grade 80 Reinforcement)

- Use of Grade 80 steel leads to a considerable reduction in the amount of reinforcement in the wall. In addition to the smaller bar sizes, lesser congestion in the special boundary elements is especially noticeable. However, the vertical spacing of the transverse hoops and cross-ties in the special boundary elements remained 5 in. as that in the Grade 60 design. This is because the maximum value of that spacing is limited to 6 times the diameter of the smallest longitudinal bar. So, smaller bar sizes achieved by higher strength reinforcement ironically led to a tighter spacing compared to what would be necessary for confinement alone. The vertical spacing of the horizontal shear reinforcement is also smaller than what is required for resisting shear so that it matches the spacing of transverse reinforcement in the boundary elements for construction efficiency. Thus, some of the gains achieved by using Grade 80 reinforcement are negated by various other considerations.



FEMA



Building Seismic
Safety Council



Design of Coupling Beam

A coupling beam oriented along the y-axis of the building at the second floor level is selected for this example. The dimensions of the beam are given below:

- Clear span of the beam, $\ell_n = 76$ in. (6.33 ft)
- Height of the beam, $h = 28$ in. (2.33 ft)
- Width of the beam, $b_w = 26$ in. (2.17 ft)
- $\ell_n/h = 76/28 = 2.7$

Since $2 < \ell_n/h < 4$, per ACI 318 Section 18.10.7.3, this beam can be designed as a deep coupling beam using two intersecting groups of diagonally placed bars, or as a special moment frame flexural member in accordance with the ACI 318 Sections 18.6.3 through 18.6.5. The second option is adopted for this example.



FEMA



Building Seismic
Safety Council



Design of Coupling Beam – Design Loads

The forces on this beam due to gravity loads are minimal. So, the design shear and moment are determined from the seismic forces alone. The governing forces on this beam come when the seismic forces are acting along the y-axis of the building. Those forces are shown below.

- $V_u = \pm 154$ kips
- $M_u = \pm 488$ ft-kips



FEMA



Building Seismic
Safety Council



Design of Coupling Beam – Design for Flexure

ACI 318 Section 18.6.3.1: Limits on flexural reinforcement

Assuming a 1.5 in. clear cover, No. 8 bars (1 in. dia.) as longitudinal reinforcement and No. 4 bars (0.5 in. dia.) as transverse reinforcement:

Effective depth, $d = 28 - 1.5 - 0.5 - 0.5 = 25.5$ in.

$$A_{s,min} \geq \frac{3\sqrt{f'_c}}{f_y} b_w d = \frac{3\sqrt{8000}}{60,000} \times 26 \times 25.5 = 2.97 \text{ in.}^2 \quad \dots(\text{ACI 318 Section 9.6.1.2(a)})$$

$$\geq \frac{200}{f_y} b_w d = \frac{200}{60,000} \times 26 \times 25.5 = 2.21 \text{ in.}^2 \quad \dots(\text{ACI 318 Section 9.6.1.2(b)})$$



Design of Coupling Beam – Design for Flexure

ACI 318 Section 18.6.3.1: Limits on flexural reinforcement

For Grade 60 steel, the maximum area of flexural reinforcement for both top and bottom faces of the beam is

$$A_{s,max} = 0.025b_wd = 0.025 \times 26 \times 25.5 = 16.58 \text{ in.}^2 \quad (\text{ACI 318 Section 18.6.3.1})$$

Also, at least two bars should be continuous at both top and bottom (ACI 318 Section 18.6.3.1).

Provided flexural reinforcement and flexural strength

The following reinforcement is provided:

- 6-No.8 bars at the bottom $\Rightarrow A_s = 4.74 \text{ in.}^2$
- 6-No.8 bars at the top $\Rightarrow A_s = 4.74 \text{ in.}^2$



FEMA



Building Seismic
Safety Council



Design of Coupling Beam – Design for Flexure

Flexural Strength Check

Using *spColumn* software, the positive and negative design moment strengths (i.e., ϕM_n^+ and ϕM_n^-) at all locations of the beam were found to be

$$\phi M_n = 526 \text{ ft-kips} > M_u (= 488 \text{ ft-kips}) \dots \text{O.K.}$$

The same reinforcement is continued through the length of the beam. For a beam with a length of 6.33 ft, it is not worth cutting off some of the bars near midspan.



FEMA



Building Seismic
Safety Council



Design of Coupling Beam – Design for Flexure

ACI 318 Section 18.6.3.2

- At the joint face, the positive moment strength must be at least half the negative moment strength. Since the top and bottom reinforcement are the same, this is automatically satisfied.
- Additionally, both the negative and the positive moment strength at any section along member length must be at least one-fourth the maximum moment strength provided at face of either joint. Since no bar is being cut-off near midspan, this requirement is also satisfied.



FEMA



Building Seismic
Safety Council



Design of Coupling Beam – Design for Flexure

ACI 318 Section 18.10.9.3 – Development Length

In a ductile coupled wall, the longitudinal reinforcement needs to be developed at both ends of the beam in accordance with ACI 318 Section 18.10.2.5. Item (a) of that section requires that for coupling beams reinforced like a special moment frame beam, the development length of longitudinal reinforcement must be 1.25 times the values calculated for f_y in tension.

Using the provisions of ACI 318 Section 25.4.2.3, the development length of No. 8 bars is calculated as 55 in.

Thus all longitudinal reinforcing bars need to be extended into the wall web by a distance of 55 in.



FEMA



Building Seismic
Safety Council



Design of Coupling Beam – Minimum Transverse Requirements

ACI 318 Section 18.6.4.1

- Confinement reinforcement is required to be provided over a length of $2h = 2 \times 28 = 56$ in. from both support faces.,
- The first hoop is to be placed no more than 2 in. from support.
- The hoop spacing must not exceed:
 - $d/4 = 25.5/4 = 6.375$ in.
 - 6 in.
 - For Grade 60 reinforcement - six times the diameter of the smallest primary flexural reinforcing bar = $6 \times 1.0 = 6$ in.
- Since this hoop spacing needs to be provided within 56 in. from both supports, and the total length of the coupling beam is 76 in., #4 confinement hoops are provided at 6 in. spacing over the whole length of the beam starting at 2 in. from each wall face.



Design of Coupling Beam – Design for Shear

ACI 318 Section 18.6.5.1

$$V_e = \frac{M_{pr}^- + M_{pr}^+}{\ell_n} = 229 \text{ kips}$$

where the probable flexural strength, M_{pr} , at the joint faces is calculated by taking the tensile stress in steel as $1.25f_y$ and the strength reduction factor ϕ as 1.0. Additionally, gravity load effects are small on this beam and are neglected for simplicity.

- With 6-No.8 bars at top and bottom: M_{pr}^+ and $M_{pr}^- = 724$ ft-kips

ACI 318 Section 18.10.4.5

$$V_{n,max} = 10A_{cv}\sqrt{f'_c} = 10 \times 26 \times 28 \times \sqrt{8000}/1000 = 651 \text{ kips} > V_e/\phi \dots \text{OK}$$



Design of Coupling Beam – Design for Shear

ACI 318 Section 18.6.5.2 – Shear Reinforcement

$$V_s = V_e / \phi = 229 / 0.75 = 305 \text{ kips}$$

Required spacing of six-legged No. 4 stirrups,

$$s = \frac{A_v f_{yt} d}{V_s} = \frac{6 \times 0.2 \times 60 \times 25.50}{305} = 6.0 \text{ in.}$$

$$V_{s,max} = 8 \sqrt{f'_c} b_w d = 8 \times \sqrt{8000} / \times 26 \times 25.5 / 1000 = 474 \text{ kips} > V_s \text{ OK}$$



Design of Coupling Beam – Design for Shear

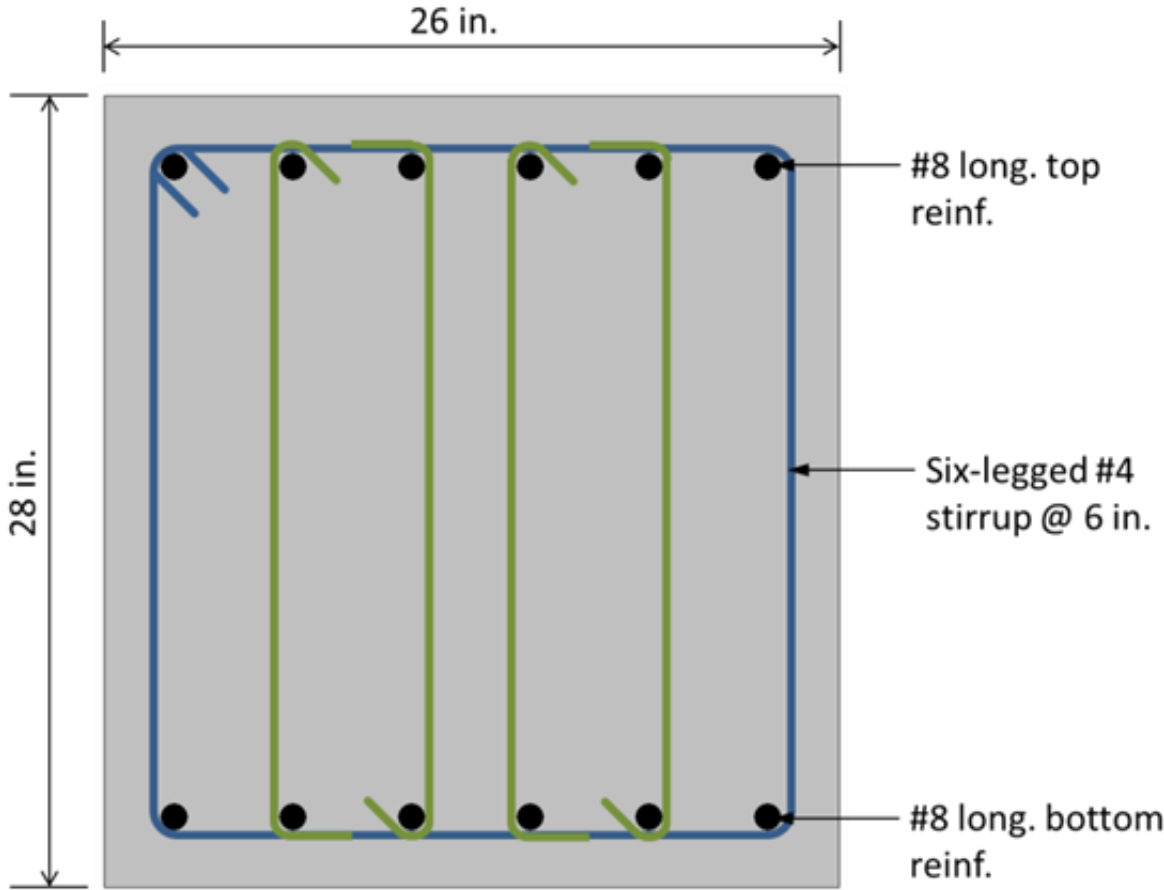

Questions



FEMA



Building Seismic
Safety Council



DISCLAIMER

- NOTICE: Any opinions, findings, conclusions, or recommendations expressed in this publication do not necessarily reflect the views of the Federal Emergency Management Agency. Additionally, neither FEMA, nor any of its employees make any warranty, expressed or implied, nor assume any legal liability or responsibility for the accuracy, completeness, or usefulness of any information, product or process included in this publication.
- The opinions expressed herein regarding the requirements of the *NEHRP Recommended Seismic Provisions*, the referenced standards, and the building codes are not to be used for design purposes. Rather the user should consult the jurisdiction's building official who has the authority to render interpretation of the code.
- This training material presentation is intended to remain complete in its entirety even if used by other presenters. While the training material could be tailored for use in other presentations, we caution users to account for issues of completeness and interpretation if only part of the material is used. We also strongly suggest users give proper credit/citation to this presentation and its authors.



FEMA



Building Seismic
Safety Council



Chapter 5 Seismic Design of Coupled Composite Plate Shear Walls / Concrete Filled (C-PSW/CF)

2020 NEHRP Provisions Training Materials

Soheil Shafaei, Ph.D., Purdue University

Amit H. Varma, Ph.D. Purdue University



FEMA



Building Seismic
Safety Council

| BSSC



Topics Covered

- Introduction to Coupled C-PSW/CFs (SpeedCore System)
- Section Detailing, Limits, Requirements
- Seismic Behavior & Capacity Design
- Design Example



FEMA



Building Seismic
Safety Council



Introduction to Coupled C-PSW/CFs (SpeedCore System)



FEMA



Building Seismic
Safety Council



C-PSW/CF (SpeedCore System)

Composite Plate Shear Walls – Concrete Filled (C-PSW/CF)

- Steel plates
 - Concrete infill
 - Tie bars
 - Shear studs
 - No rebars or formwork
-
- Shear walls and/or elevation core walls

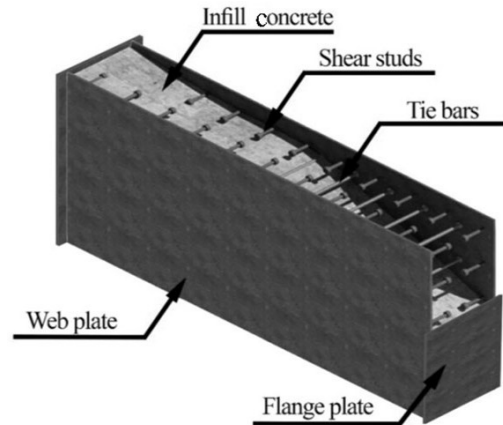

The SpeedCore system has evolved organically from this past with steel-concrete composite construction. C-PSW/CF or composite walls consist of steel modules that are filled with concrete! The steel modules consist of steel plates, tie bars and maybe shear studs. There are no rebars at all and no need for formwork or falsework for construction. These composite walls can be used as shear walls or elevator core walls in lieu of conventional reinforced concrete walls.

A New Chapter in Composite Construction

Rainier Square, Seattle

- Client



- Architect



- Structural & Civil



- GC/GM



FEMA



Building Seismic Safety Council



Courtesy of Magnusson Klemencic Associates

A New Chapter in Composite Construction

▪ Steel Fabricator:



▪ Steel Erector:



▪ Rebar Fabricator:



▪ Concrete Supplier:



FEMA



Building Seismic Safety Council



Courtesy of Magnusson Klemencic Associates

The contributions, early engagement, and detailed discussions with the steel fabricator and erector were key for the success of the project.

A New Chapter in Composite Construction

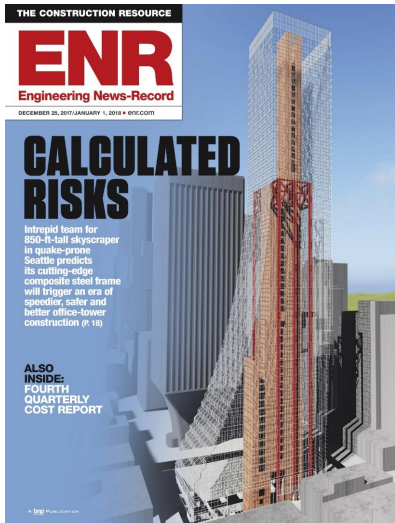

Cover of ENR Magazine

Constructed in 10 months

Eight months savings as compared to conventional RC construction

1.4 million square feet

850-foot tall

58-story office + residential

7 levels below-grade parking



FEMA



Building Seismic Safety Council



The main reason for considering SpeedCore for this project was the **SPEED OF CONSTRUCTION**. This structure was constructed in 10 months, providing savings of about 8 months as compared to conventional RC construction. This structure and its conceiver are so iconic that they both ended up on the cover of the ENR.

Coupled Composite Plate Shear Walls – Core Walls

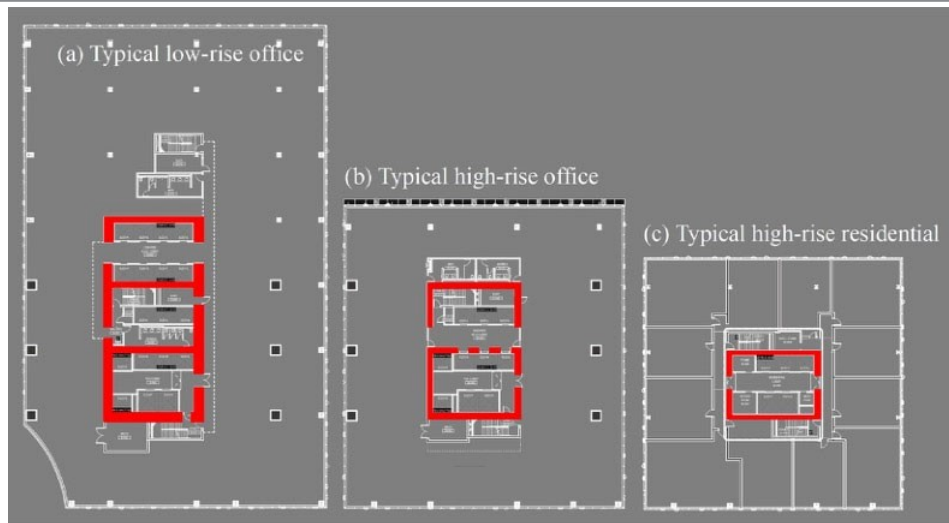

Courtesy of Magnusson Klemencic Associates



FEMA



Building Seismic
Safety Council



From an engineering perspective, the coupled composite core walls are highlighted within the structural floor plans along the structure height here. They are replacing the convention RC elevator core wall structures.

A New Chapter in Composite Construction



200 Park Avenue, San Jose, CA

- High seismic region
- 937,000 square foot
- 19 stories
- Under construction

Copyright Gensler

(Modern Steel Construction, February 2021)



FEMA



Building Seismic
Safety Council



The first application of SpeedCore in a high seismic region is 200 Park Avenue in San Jose. This 19-story structure is under construction.

Section Detailing, Limits, Requirements



FEMA



Building Seismic
Safety Council



Key Components of C-PSW/CF (SpeedCore System)

- Steel plates
- Concrete infill
- Tie bars
- Shear studs

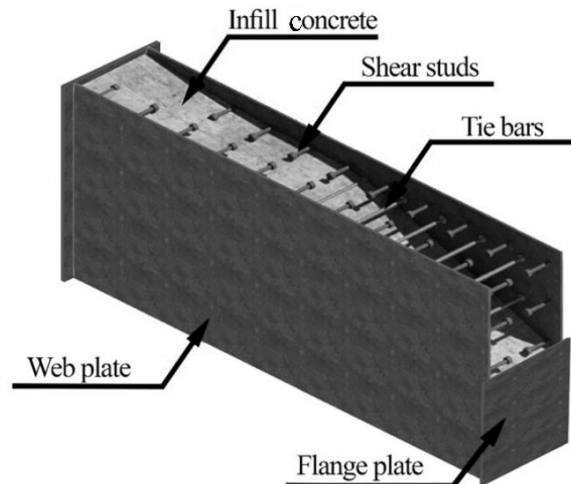

FEMA



Building Seismic
Safety Council



These are the key components of SpeedCore composite walls. Just a reminder / reference picture. Its quite simple. Steel plates or module, tie bars / shear studs, and concrete infill.

Steel Plates

- Reinforcement ratio limits:
Minimum = 1% Maximum = 10%
- Two steel plates must be connected to each other using ties
- Ties can consist of bars, steel shapes, or built-up shapes
- Steel plates must be anchored to concrete infill using stud anchors or ties or combination of ties and studs



FEMA



Building Seismic
Safety Council



For the steel plates, the minimum and maximum reinforcement ratio limits are 1% and 10%. These are based on the range of parameters considered in research. The steel plates have to be connected to each other using ties. These ties can consist of steel bars, rods, or shapes. To prevent local buckling and develop composite action, the steel plates must be anchored to the concrete infill using studs, ties, or a combination of both.

Local Buckling, Plate Slenderness, Axial Compression

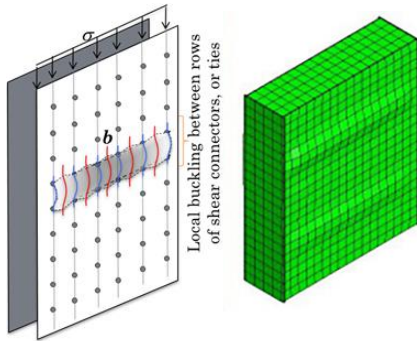

(Zhang et al. 2014, 2020)

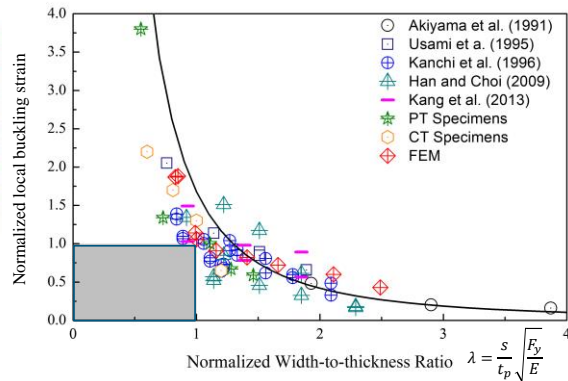

FEMA

Building Seismic Safety Council



Under compressive stresses, local buckling can occur in the steel plates in between the anchor points provided by studs or ties. The plate slenderness ratio is defined as the anchor spacing s divided by plate thickness t_p . Years of experimental and numerical investigations conducted around the world are summarized in this plot between the normalized plate slenderness ratio and the normalized local buckling strain (e_{cr}/e_Y). The rectangular shaded region is of interest for design, because there are no data point in it indicating the slenderness limit.

Local Buckling, Plate Slenderness, Axial Compression

Seismic Design:

$$\frac{b}{t_p} \leq 1.05 \sqrt{\frac{E_s}{R_y F_y}}$$



$$F_{cr} \geq F_y$$

$$P_{no} = A_s F_y + 0.85 f'_c A_c$$

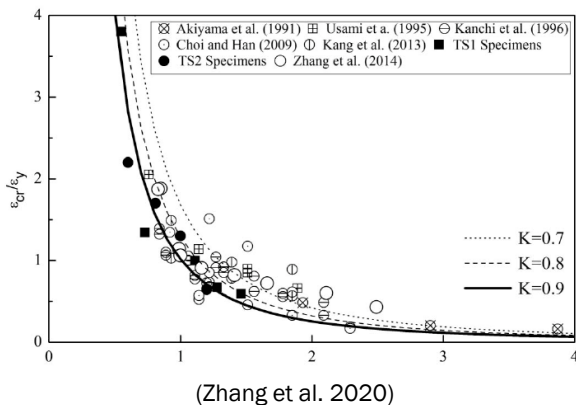

FEMA

Building Seismic
Safety Council



Using these experimental and numerical results, plate slenderness requirements were developed to ensure compactness, i.e, yielding in compression occurs before local buckling. Equations were also developed for slender plates, but the code requires nonslender or compact plates for the seismic design. These requirements are slightly tighter for seismic design as they should be.

Local Buckling, Plate Slenderness, Axial Compression

- In accordance with AISC 341-22 Section H7.5s, steel plate slenderness ratio at the base of C-PSW/CF (protected zones) should be limited as follows:

$$\frac{S}{t_p} < 1.05 \sqrt{\frac{E_s}{R_y F_y}}$$

- Steel plate slenderness ratio at regions, which are protected zones should be limited as follows:

$$\frac{S}{t_p} < 1.2 \sqrt{\frac{E_s}{F_y}}$$



Tie Bar Size, Spacing, and Stability of Empty Modules

- Empty steel module flexibility governed by effective shear stiffness $(GA)_{\text{eff}}$ associated with Vierendeel truss / frame action

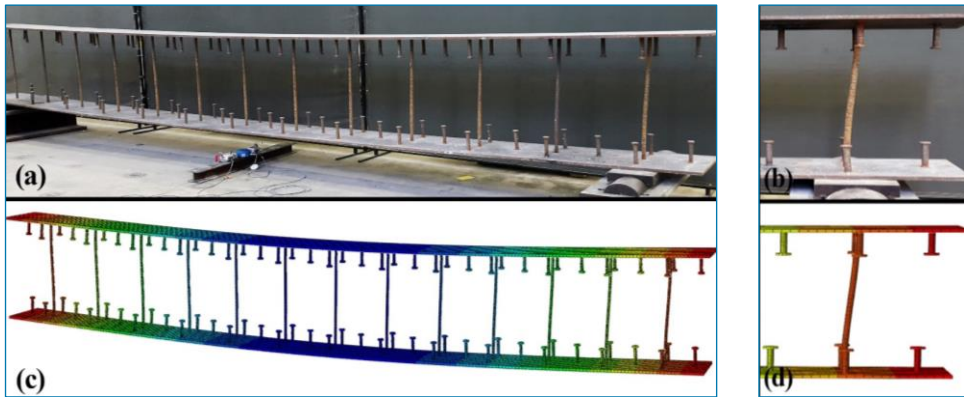

(Varma et al., 2019)



FEMA



Building Seismic
Safety Council



$$\Delta_{\text{total}} = \frac{5 \times wL^4}{384 \times EI_{\text{total}}} + \frac{wL^2}{8 \times GA_{\text{eff}}}$$

16

The design of tie bars is often governed by the design requirements for empty steel modules before concrete placement. Experimental investigations and numerical studies show that the flexibility of empty steel modules is dominated by the “effective shear stiffness” associated with Vierendeel truss / frame action. This is useful when considering behavior during transportation, handling, and erection activities.

Tie Bar Size, Spacing, and Stability of Empty Modules

- Stability of empty modules during erection, construction and concrete placement → important consideration for design

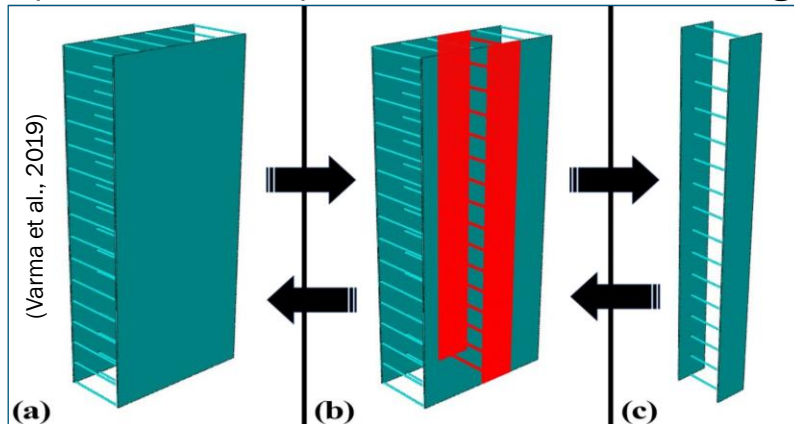

FEMA



Building Seismic
Safety Council



The stability of empty modules during erection, construction, and concrete placement is an important design concern, which ends us governing the tie bar size and spacing / detailing. We looked at the global buckling of a unit width of the empty module, which is conservative but representative. Unit width is defined by the tie bar spacing in the horizontal direction.

Tie Bar Size, Spacing, and Stability of Empty Modules

- Minimum $(GA)_{\text{eff}}$ of empty module for transportation, erection, and stability during construction, concrete casting
- Refined calculations can be made using theory
- Recommendations for tie bar size

$$\frac{S}{t_p} < 1.0 \sqrt{\frac{E_s}{2\alpha + 1}}$$

$$\text{Where, } \alpha = 1.7 \left(\frac{t_{sc}}{t_p} - 2 \right) \left(\frac{t_p}{d_{tie}} \right)^4$$

- α is the ratio of plate flexural stiffness to tie flexural stiffness
- α governs the value of $(GA)_{\text{eff}}$ and thus the tie spacing S/t_p requirement
- Still need to meet plate slenderness req.



FEMA



Building Seismic
Safety Council



18

Using all these experimental and analytical results, we developed minimum requirements for the stiffness of empty modules and to simplify design checks. The minimum tie size and spacing requirements are summarized. Alpha is the ratio of steel plate flexural stiffness to tie bar flexural stiffness. It governs the value of $(GA)_{\text{eff}}$, and thus the S/t_p , tie spacing to plate thickness requirement. This requirement is to be used along with the local buckling slenderness requirement. Together they govern the section detailing of composite walls.

Recommendations for Stiffness

In-Plane Flexural Stiffness

- Account for concrete cracking corresponding to the required strength level
- Section moment-curvature response → secant stiffness corresponding to 60% of moment capacity
- Extent of concrete cracking, if drift governs or walls are overdesigned

$$EI_{eff} = E_s I_s + 0.35 E_c I_c \quad \text{Effective flexural stiffnesses (AISC Design Guide 37, 2021)}$$

$$EA_{eff} = E_s A_s + 0.45 E_c A_c \quad \text{Effective axial stiffnesses (AISC Design Guide 37, 2021)}$$

$$GA_{v,eff} = G_s A_{s,wall} + G_c A_c \quad \text{Effective shear stiffnesses (AISC Design Guide 37, 2021)}$$



FEMA

Building Seismic
Safety Council



These are the recommendations for the effective stiffness values when modeling SpeedCore walls for analysis for calculating design demands. The stiffness should account for concrete cracking corresponding to the design scenario. The engineer can perform a section moment-curvature analysis to estimate stiffness, and account for the extent of concrete cracking (which may be quite limited) if drift governs for lateral wind loading. In the absence of better information, we have provided some simple stiffness recommendations for the engineer to consider / use.

Recommendations for Flexural Strength

Plastic stress distribution over composite cross-section

- Steel in compression & tension $\rightarrow f_y$
- Compression concrete $\rightarrow 0.85f'_c$
- Equilibrium to calc. plastic neutral axis location, c
- Plastic moment M_p

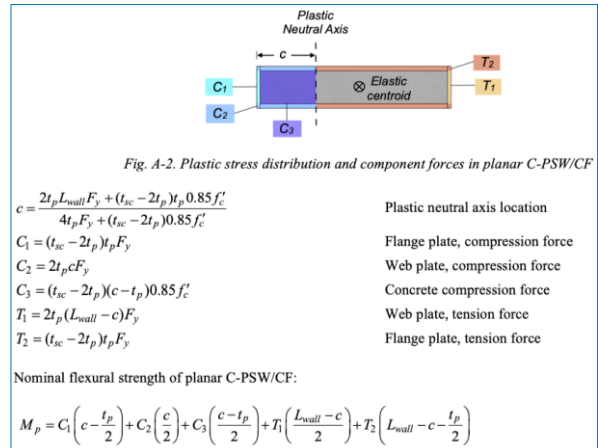

FEMA

Building Seismic Safety Council



(AISC Design Guide 37, 2021)

20

The in-plane flexural strength of SC walls can be calculated using plastic stress distribution over the composite cross-section. Its quite simple, with the steel limited to yield stress F_y in compression and tension, and concrete to $0.85 f'_c$ in compression. Equations have been developed and provided in the *Design Guide* (I will mention at the end of my talk).

Recommendations for Shear Strength

- In accordance with AISC 360-22 Section I4.4, nominal in-plane shear strength of L-shaped C-PSW/CFs is determined considering the steel section and infill concrete contributions as follows:

$$V_{n.wall} = \frac{K_s + K_{sc}}{\sqrt{3 K_s^2 + K_{sc}^2}} A_{s.wall} F_y \quad (\text{AISC Design Guide 37, 2021})$$

where, $K_s = G_s A_{s.wall}$ (AISC Design Guide 37, 2021)

where, $K_{sc} = \frac{0.7 (E_c A_c) (E_s A_{s.wall})}{(4 E_s A_{s.wall}) (E_c A_c)}$ (AISC Design Guide 37, 2021)



FEMA

 Building Seismic Safety Council



Seismic Design of Coupled Composite Plate Shear Walls / Concrete Filled (Capacity Design)



FEMA



Building Seismic
Safety Council



Seismic Design of Coupled C-PSW/CF

- Seismic design can be performed using ASCE/SEI 7-22, AISC 341-22 *Seismic Provisions*, and AISC *Design Guide 37* (2021).
- Design procedure for coupled C-PSW/CF is presented in FEMA P-2082 *NEHRP Provisions* (2020) and AISC *Design Guide 37* (2021).



FEMA



Building Seismic
Safety Council



Seismic design can be performed according to FEMA P-2082 NEHRP (2020), ASCE/SEI 7-22 Standard, ANSI/AISC 341-22 *Seismic Provisions*, and AISC *Design Guide 37* (2021). Performance-based design can also be conducted, but that is beyond the scope of this presentation.

Seismic Design of Coupled C-PSW/CF

The 2020 Edition of the *NEHRP Recommended Seismic Provisions*:

- Response modification factor $R = 8$
- Over-strength factor $\Omega_0 = 2.5$
- deflection amplification factor $C_d = 5.5$



FEMA

 Building Seismic
Safety Council



Seismic Design Philosophy for Coupled C-PSW/CF

- Coupling beams form plastic hinges and distributed plasticity along structure height
- Walls sized to develop plastic hinges along entire wall height

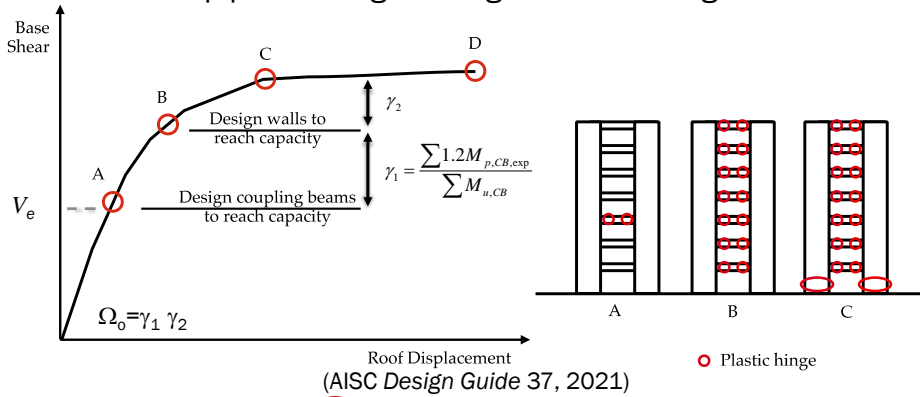

FEMA

Building Seismic Safety Council



Seismic Design Philosophy

2D Finite Element Model (Pushover Response)

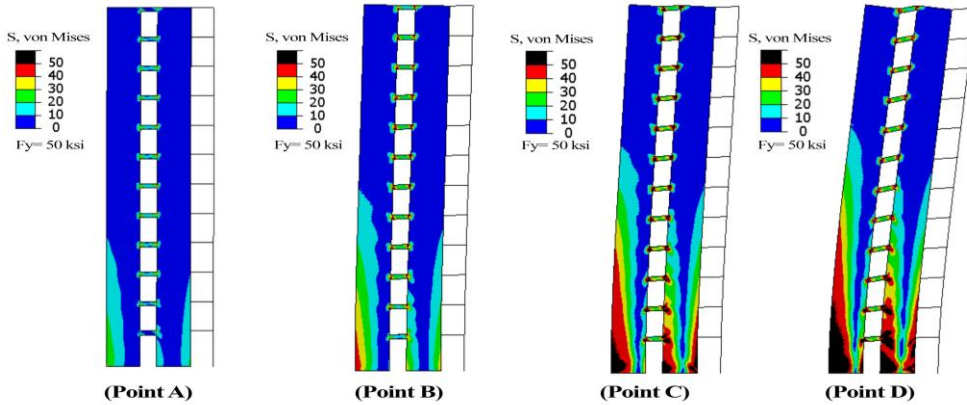
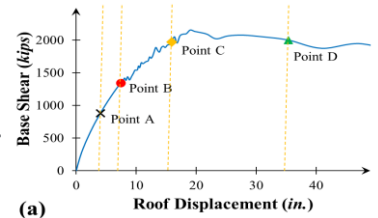

(Shafaei et al., 2022)

This is showing the same system level behavior but now using the 2D finite element model. In these figures black indicates beyond yielding. Again, the system shows desired and designed behavior. Between “Point A” and “Point B” all coupling beams yield along height of structure. At “Point C” wall forms plastic hinge at base. Coupling beams fracture at “Point D”.

Design Example

Building Description

- Coupled L-shaped Composite Plate Shear Walls / Concrete Filled (C-PSW/CFs) are used to resist seismic loads.
- Steel gravity frames are placed around the coupled C-PSW/CFs, and elevators and stairs are located inside the core walls

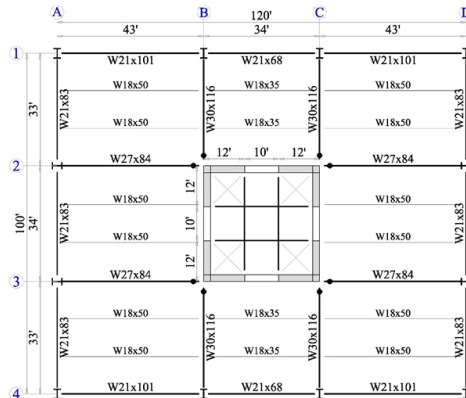

FEMA

Building Seismic
Safety Council



Floor plan of the office building with 120 ft length and 100 ft width (a total of 12,000 square feet of area)

Building Description

- 18-story office building
- First story height = 17 ft
- Typical story height = 13 ft
- Total height = 238 ft.

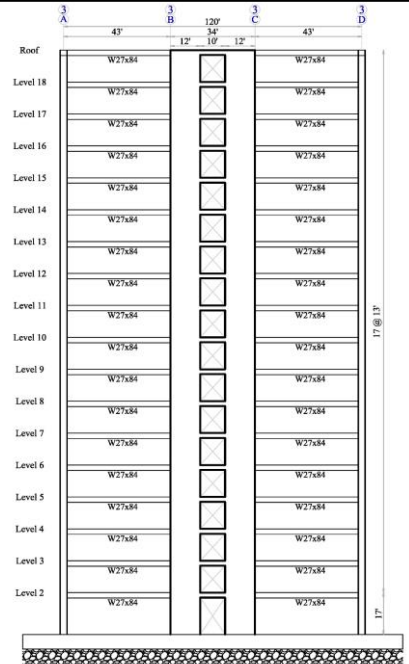

Material Properties

Steel:

- ASTM A572 Grade 50 steel (steel plates) & ASTM A992 Grade 50 steel (wide flange sections)
- $F_y = 50$ ksi
- $F_u = 65$ ksi
- $E_s = 29,000$ ksi
- $G_s = 11,500$ ksi
- $R_y = 1.1$ (ANSI/AISC 341-22 Table A3.1)

Concrete:

- Self-compacting concrete (SCC)
- $f'_c = 6$ ksi
- $E_c = 4,500$ ksi
- $G_c = 1,770$ ksi
- $R_c = 1.5$ (ANSI/AISC 341-16 H5-5)



Floor plan of the office building with 120 ft length and 100 ft width (a total of 12,000 square feet of area)

Loads & Load Combinations

Loads:

- Self-weight of structure (gravity frames and core walls) (dead load)
- Floor live load = 50 psf (Redactable)
- Partition = 15 psf
- Superimposed dead load (ceiling and floor finish) = 15 psf
- Curtain wall = 15 psf (wall surface area)

Load Combinations:

- Load combination provided in Chapter 2 of ASCE/SEI 7-16 are considered.
- $1.4D$
- $1.2D + 1.6L$
- $1.2D + 0.5L \pm 1.0E$
- $0.9D \pm 1.0E$



FEMA

Building Seismic
Safety Council



Floor plan of the office building with 120 ft length and 100 ft width (a total of 12,000 square feet of area)

Building Description

- 3D computer model of the building was developed using a commercial software program for the design of steel gravity frames.
- Based on the preliminary design of gravity frames, the self-weight of structure is calculated.

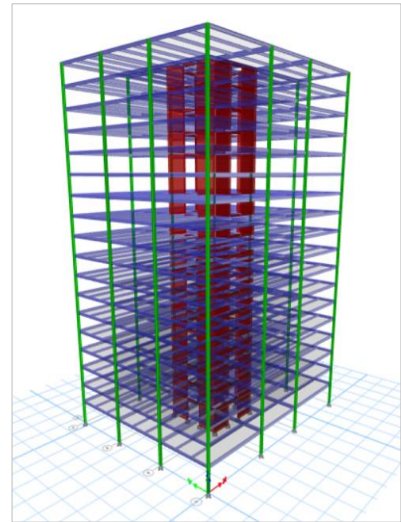

FEMA

Building Seismic
Safety Council



Seismic Forces

Building Seismic Weight:

- First Story = 1,555 kips
- Typical Story = 1,440 kips
- Roof = 1,263 kips

Seismic Design Parameters:

- $S_{DS} = 1.101g$
- $S_{D1} = 0.650g$
- Site Class D
- Risk Category II
- Seismic Design Category D

Period of the structure

- $T_a = C_t h_n^x = (0.020) (238 ft)^{0.75} = 1.21$ seconds
- $C_u = 1.4$ (ASCE/SEI 7 Table 12.8-1)
- $T = C_u T_a = (1.4) (1.21) = 1.70$ seconds
- $T = 1.87$ (3D ETABS model)
- The period of structure is considered to be the upper limit, $C_u T_a = 1.70$



FEMA

Building Seismic
Safety Council



Period of the structure is calculated according to Section 12.8.2 of ASCE/SEI 7-16 standard. The approximate period is generally lower a detailed computational model; therefore, an upper limit on the period recommended by ASCE/SEI 7-16 *Standard* is considered. The period of structure is also estimated using a detailed 3D computer model developed in ETABS software program. The computed period of 3D ETABS model is 1.87, which is higher than the upper limit. Therefore, the period of structure is considered to be the upper limit.

Design Base Shear

Equivalent Lateral Forces (ELF) procedure was used to calculate the seismic loads:

- $V = C_s W$
- $C_s = \frac{S_{DS}}{R/I_e} = \frac{1.101}{8/1} = 0.138$ (ASCE/SEI 7 12.8-2)
- $C_{s,Max} = \frac{S_{DS}}{T(R/I_e)} = \frac{1.101}{1.7(8/1)} = \mathbf{0.048}$ (ASCE/SEI 7 12.8-3)
- $C_{s,Min} = 0.44 S_{DS} I_e = (0.44)(1.101)(1) = 0.048$ (ASCE/SEI 7 12.8-5)
- $C_s = \frac{0.5 S_1}{(R/I_e)} = \frac{(0.5)(0.65)}{(8/1)} = \mathbf{0.041}$ (ASCE/SEI 7 12.8-6)
- $\mathbf{V = C_s W = (0.048) (25844) = 1,238 \text{ kips}}$
- $\mathbf{OTM = \sum_{i=1}^n F_i h_i = 217,217 \text{ kip}\cdot\text{ft}}$



FEMA



Building Seismic
Safety Council



Seismic response coefficient is selected 0.048 and the design base shear is calculated 1238 kips.

The overturning moment (OTM) of the building is computed 217,217 kip-ft.

C-PSW/CFs and Coupling Beam Dimensions

C-PSW/CF:

- $L_w = 12$ ft
- $t_{sc} = 16$ in.
- $t_p = \frac{1}{2}$ in.

Coupling beams:

- $L_{CB} = 10$ ft
- $b_{CB} = 16$ in.
- $h_{CB} = 24$ in.
- $t_{CB,f} = \frac{1}{2}$ in.
- $t_{CB,w} = \frac{3}{8}$ in.
- $L_{CB}/h_{CB} = 5$

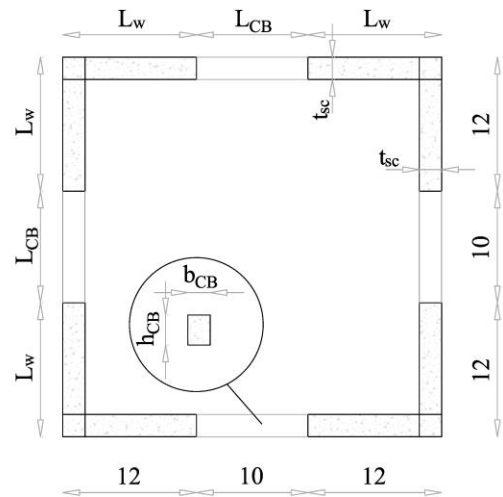

FEMA

Building Seismic
Safety Council



L-shape C-PSW/CFs have length (L_w) of 12 feet, wall thicknesses (t_{sc}) of 16 in., and steel plate thicknesses (t_p) of $\frac{1}{2}$ in. Composite coupling beam width (b_{CB}) and height (h_{CB}) are 16 and 24 in., respectively. Coupling beam flange ($t_{CB,f}$) and web ($t_{CB,w}$) plate thicknesses are $\frac{1}{2}$ and $\frac{3}{8}$ in., respectively.

2D Modeling of Coupled C-PSW/CF

C-PSW/CF:

(AISC Design Guide 37, 2021)

- $EI_{eff} = E_s I_s + 0.35 E_c I_c$
- $EA_{eff} = E_s A_s + 0.45 E_c A_c$
- $GA_{v,eff} = G_s A_{s,wall} + G_c A_c$

Coupling beams:

(AISC Design Guide 37, 2021)

- $0.64 EI_{eff,CB}$
- $0.8 EA_{eff,CB}$
- $GA_{v,eff,CB}$
- $L_{eff} = 323.8 \text{ in.}$

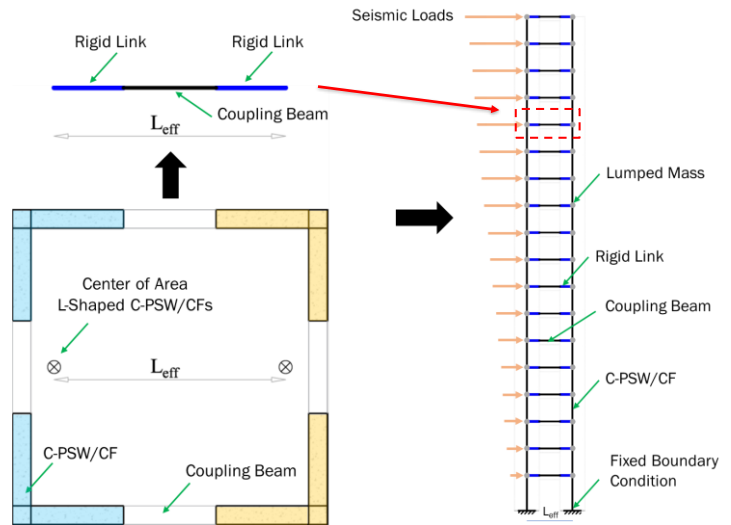

FEMA



Building Seismic Safety Council



In seismic design, 2D computer model of coupled C-PSW/CFs was developed using a commercial software (SAP2000) to determine the inter-story drift and shear force demands in coupling beams. Coupling beams and L-shape C-PSW/CFs were modeled using beam elements. When the coupled C-PSW/CFs are subjected to lateral seismic loads, two walls are in tension and the other two walls in compression due to the coupling action. In this example, the two compression or tension walls are considered one wall (beam element) in computer modeling and the limit state checks. Additionally, in 2D computer model, flexural, axial, and shear stiffnesses of coupling beam are doubled to model the two beams.

Inter-story Drift Limit

- Deformation shape, lateral displacement, and inter-story drift.
- Amplified displacement is calculated by multiplying story displacement value by the deflection amplification factor. Inter-story drift is calculated using the amplified displacement.
- Maximum inter-story is 1.65%.

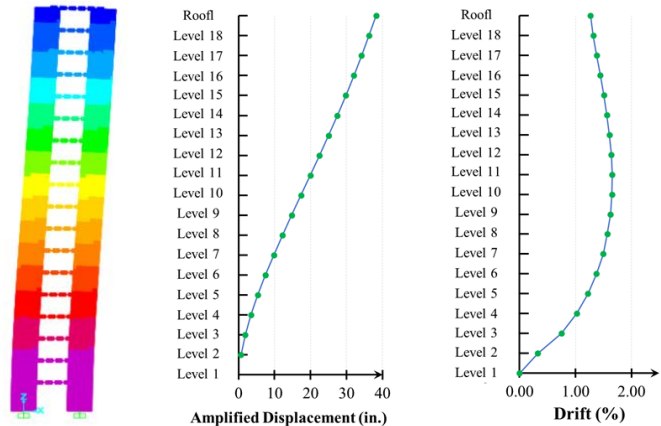

FEMA

Building Seismic Safety Council



Linear elastic analysis was performed to determine the lateral deflection and coupling beam shear force demands. Amplified displacement is calculated by multiplying story displacement value by the deflection amplification factor (C_d). Inter-story drift is calculated using the amplified displacement. In this design example, the maximum design inter-story drift is limited to 2% in accordance with the ASCE/SEI 7 *Standard*. From the structural analysis of 2D model, maximum inter-story of the structure is 1.65%, which is lower than the maximum design inter-story drift limit. Figure shows deformation shape, lateral displacement, and inter-story drift of coupled C-PSW/CFs.

Linear Elastic Analysis

- $V_{r.CB} = 167$ kips (average)
- $V_{Max.CB} = 223.5$ kips (maximum)
- $M_{U.CB} = \frac{V_{r.CB} L_{CB}}{2} = 835$ kip-ft
- $M_{Max.CB} = \frac{V_{Max.CB} L_{CB}}{2} = 1,117$ kip-ft

(#)	Story Elevation (ft.)	Disp. (in.)	Amplified Disp. (in.)	Inter story Drift (%)	CB Shear Force (kips)
Roof	238	6.95	38.24	1.32	89.2
Level 18	225	6.59	36.26	1.38	97.1
Level 17	212	6.22	34.20	1.44	110.2
Level 16	199	5.83	32.05	1.51	126.0
Level 15	186	5.42	29.80	1.56	129.4
Level 14	173	4.99	27.45	1.61	159.9
Level 13	160	4.55	25.01	1.64	176.0
Level 12	147	4.09	22.50	1.65	190.6
Level 11	134	3.63	19.94	1.65	203.1
Level 10	121	3.16	17.36	1.63	213.1
Level 9	108	2.69	14.79	1.57	220.1
Level 8	95	2.23	12.25	1.49	223.5
Level 7	82	1.78	9.81	1.38	222.4
Level 6	69	1.36	7.47	1.22	216.0
Level 5	56	0.97	5.33	1.02	202.8
Level 4	43	0.62	3.42	0.75	180.9
Level 3	30	0.33	1.83	0.33	147.5
Level 2	17	0.12	0.67	0.00	98.7



FEMA

Building Seismic Safety Council



From the structural analysis of 2D model, the average and maximum required shear strengths ($V_{r.CB}$ and $V_{max.CB}$) for coupling beams are calculated. The average required shear strength is used to size the coupling beams. Structural designers can choose to use the average or maximum required shear strengths. Since a portion of the OTM will be resisted by the coupling action and the remainder by the individual walls, the result of this choice is the relative proportioning of wall and coupling beam elements. Since the system is designed to ensure plasticity spreads along the height of the structure, either method is acceptable. The average and maximum required shear strengths for coupling beams are 167 and 223.5 kips, respectively. The average and maximum required flexural strengths ($M_{U.CB}$ and $M_{max.CB}$) for coupling beams are calculated 835 and 1,117 kip-ft, respectively.

Design Of Coupling Beams

Flexure-Critical Coupling Beams:

- $V_{n.exp.CB} \geq \frac{2.4 M_{p.exp.CB}}{L_{CB}}$ (AISC Design Guide 37, 2021)

Expected Flexural Capacity ($M_{p.exp.CB}$):

- $M_{p.exp.CB} = 1,582.6 \text{ kip-ft}$

Minimum Area of Steel:

- $A_{s.CB.min} = 0.01 h_{CB} b_{CB} = (0.01)(24)(16) = 3.8 \text{ in.}^2$ (AISC Spec. I2.2a)
- $A_{s.CB} = 33.25 > A_{s.CB.min} = 3.8 \text{ in.}^2$



FEMA

Building Seismic
Safety Council



Coupling beams of coupled C-PSW/CF systems are designed to be a flexure critical member in accordance with ANSI/AISC 341-22 Section H8.5c.

The expected flexural capacity ($M_{p.exp.CB}$) of coupling beam is calculated assuming the steel plate reaches a yield stress of $R_y F_y$ (in both compression and tension) and infill concrete reaches a yield stress of $R_c f'_c$ (in compression).

In accordance AISC 360-22 Section I2.2a, steel plates should comprise at least 1% of the total cross section area of composite coupling beam.

Design Of Coupling Beams

Steel Plate Slenderness Requirement for Coupling Beams:

- $\frac{b_{c,CB}}{t_{CB,f}} = 30.5 < 2.37 \sqrt{\frac{E_s}{R_y F_y}} = 2.37 \sqrt{\frac{29000}{(1.1)(50)}} = 54.4$ (AISC 360-22 Table I1.1b)
- $\frac{h_{c,CB}}{t_{CB,w}} = 61.3 \geq 2.66 \sqrt{\frac{E_s}{R_y F_y}} = 2.66 \sqrt{\frac{29000}{(1.1)(50)}} = 61.1$ (AISC 360-22 Table I1.1b)

Flexural Strength ($M_{p,CB}$):

- $M_{n,CB} = M_{p,CB} = 1,407$ kip-ft (AISC Design Guide 37, 2021)
- $\phi_b M_{n,CB} = 1,266$ kip-ft $> M_{U,CB} = 835$ kip-ft
- $\frac{M_{r,CB}}{\phi_b M_{n,CB}} = 0.66$ $\frac{M_{U,CB,Max}}{\phi_b M_{n,CB}} = 0.88$



FEMA

Building Seismic
Safety Council



Although the slenderness ratio of web plate is slightly higher than the requirement for, in this design example, it is assumed the web plates of coupling beams meet the requirement

In seismic design of coupled C-PSW/CFs, composite coupling beams are designed to be compact sections. The slenderness requirements of flange and web plates are checked in accordance with AISC 360-22 Section I1.4.

Plastic stress distribution method is used to calculate flexural capacity ($M_{p,CB}$). The flexural capacity ($M_{p,CB}$) of coupling beam is calculated assuming the steel plate reaches a yield stress of F_y (in both compression and tension) and infill concrete reaches a stress of $0.85f'_c$ (in compression).

Design Of Coupling Beams

Nominal Shear Strength ($V_{n,CB}$):

- $V_{n,CB} = 0.6 F_y A_{w,CB} + 0.06 K_c \sqrt{f'_c} A_{c,CB} = 592 \text{ kips}$ (AISC Design Guide 37, 2021)

- $\phi_v V_{n,CB} = 532 \text{ kips} > V_{U,CB} = 167 \text{ kips}$

$$\frac{V_{r,CB}}{\phi_v V_{n,CB}} = \frac{167 \text{ kips}}{532 \text{ kips}} = 0.31 \qquad \frac{V_{U,CB}}{\phi_v V_{n,CB}} = \frac{223.5 \text{ kips}}{532 \text{ kips}} = 0.42$$

Flexure-Critical Coupling Beams (revisited):

- $V_{n,exp,CB} = 0.6 R_y F_y A_{w,CB} + 0.06 K_c \sqrt{R_c f'_c} A_{c,CB} = 657 \text{ kips}$

- $V_{n,exp,CB} = 657 \text{ kips} > \frac{2.4 M_{p,exp,CB}}{L_{CB}} = 380 \text{ kips}$ (AISC Design Guide 37, 2021)



FEMA

Building Seismic
Safety Council



Nominal shear strength, $V_{n,CB}$, of composite coupling beam is calculated in accordance with AISC 360-22 Section I4.2. The nominal shear strength is the summation of shear strengths of steel web plates (V_s) and infill concrete (V_c). The selected composite coupling beams are flexure critical members.

Design Of C-PSW/CFs

Minimum and Maximum Area of Steel:

- $A_{gross.wall} = (2)[(L_w t_{sc}) + (L_w - t_{sc})t_{sc}] = 8,704 \text{ in.}^2$
- $A_{s.min} = 0.01 A_{gross.wall} = (0.01)(8,704) = 87 \text{ in.}^2$ (ANSI/AISC 360-22 I2.2a)
- $A_{s.max} = 0.1 A_{gross.wall} = (0.1)(8,704) = 870 \text{ in.}^2$ (ANSI/AISC 360-22 I2.2a)
- $A_s = (t_p)[8L_w + 4t_{sc} - 16t_p] = 604 \text{ in.}^2$
- $A_{s.min} = 87 \text{ in.}^2 < A_s = 604 \text{ in.}^2 < A_{s.max} = 870 \text{ in.}^2$



In accordance with ANSI/AISC 360-22 Section I1.6, the steel plates in C-PSW/CF should comprise at least 1% but no more than 10% of the total composite cross-section area.

Design Of C-PSW/CFs

Slenderness Requirements:

- In accordance with ANSI/AISC 341-22 Section H8.4b, steel plate slenderness ratio, b/t , at the base of C-PSW/CF (protected zones) should be limited as follows:
 - $S_{tie} = 12$ in. (the bottom two stories)
 - $\frac{S_{tie}}{t_p} = 24 < 1.05 \sqrt{\frac{E_s}{R_y F_y}} = 1.05 \sqrt{\frac{29,000}{(1.1)(50)}} = 24.1$ (ANSI/AISC 341-22 H8.4b)
 - Steel plate slenderness ratio, b/t , at regions which are not protected zones:
 - $S_{tie.top} = 14$ in.
 - $\frac{S_{tie.top}}{t_p} = 28 < 1.2 \sqrt{\frac{E_s}{F_y}} = 1.2 \sqrt{\frac{29,000}{(50)}} = 28.9$ (ANSI/AISC 360-22)



FEMA

Building Seismic
Safety Council



In this design example, steel tie bars are only used in L-shaped C-PSW/CFs (on shear studs); therefore, the largest unsupported length between tie bars is considered for slenderness requirements check. Tie bar spacings are selected 12 and 14 in. for the bottom (the bottom two stories) and top (remaining stories) of L-shaped C-PSW/CFs.

Design Of C-PSW/CFs

Tie spacing requirements:

- In accordance with ANSI/AISC 360-22 Section I1.6b, the tie bar spacing to plate thickness ratio, S/t_p , should be limited as follows:
- $d_{tie} = 3/4 \text{ in.}$
- $\alpha = 1.7 \left(\frac{t_{sc}}{t_p} - 2 \right) \left(\frac{t_p}{d_{tie}} \right)^4 = 1.7 \left(\frac{16}{0.5} - 2 \right) \left(\frac{0.5}{0.75} \right)^4 = 10.07$ (AISC Design Guide 37, 2021)
- $\frac{S_{tie.bottom}}{t_p} = 24 < 1.0 \sqrt{\frac{E_s}{2\alpha + 1}} = 1.0 \sqrt{\frac{29,000}{2(10.07)+1}} = 37.0$ (AISC Design Guide 37, 2021)
- $\frac{S_{tie.top}}{t_p} = 32 < 1.0 \sqrt{\frac{E_s}{2\alpha + 1}} = 1.0 \sqrt{\frac{29,000}{2(10.07)+1}} = 37.0$ (AISC Design Guide 37, 2021)



FEMA

Building Seismic
Safety Council



The stability of empty steel module of C-PSW/CF during the construction and concrete casting depends on tie bar spacing to plate thickness ratio.

Design Of C-PSW/CFs

Required Wall Shear Strength:

- A shear amplification factor of 4 is used to amplify the base shear.
- $V_{Amplified} = 4,952$ kips (AISC Design Guide 37, 2021)
- $V_{r.wall} = \frac{4,952}{2} = 2,476$ kips



Design Of C-PSW/CFs

Required Flexural Strength of Coupled C-PSW/CFs

- A shear amplification factor of 4 is used to amplify the base shear.
- $M_{p.exp.CB} = 1,583$ kip-ft (Expected flexural capacity of CB)
- $V_{n.Mp.exp.CB} = \frac{2.4 M_{p.exp.CB}}{L_{CB}} = 380$ kips (Expected shear strength of CB)
- $\gamma_1 = \frac{\sum_n 1.2 M_{p.exp.CB}}{\sum_n M_{U.CB}} = \frac{(18)(1.2)(1583)}{(18)(835)} = 2.27$ (Overstrength amplification factor)
- $P_{CB} = 2 \sum_n V_{n.Mp.exp.CB} = 13,673$ kips (Axial force due to coupling action)
- $M_{r.wall} = \gamma_1 OTM - P_{CB} L_{eff} = 125,077$ kip-ft (Required amplified OTM)
- $P = -2 \sum_n V_{n.Mp.exp.CB} - (1.2 \sum_n F_{Tri.DL}) - (0.5 \sum_n F_{Tri.LL}) = -20,644$ kips (axial compression force)
- $T = 2 \sum_n V_{n.Mp.exp.CB} - (0.9 \sum_n F_{Tri.DL}) = 9,219$ kips (axial tension force)



FEMA

Building Seismic
Safety Council



Design Of C-PSW/CFs

Wall Tensile Strength:

- $P_{n.T} = A_s F_y = (604)(50) = 30,200$ kips
- $\phi_t P_{n.T} = 27,180$ kips $> T = 9,219$ kips
- $\frac{T}{\phi_t P_{n.T}} = 0.35$

Wall Compression Strength:

- A simplified unit width method is considered to calculate nominal compression strength.

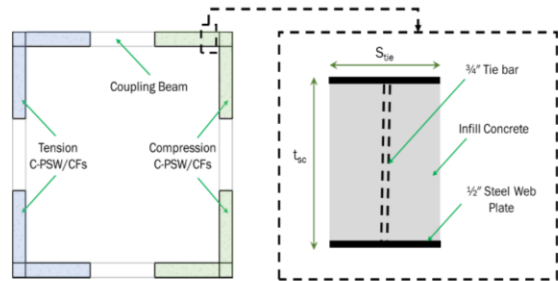

FEMA

Building Seismic
Safety Council



A simplified unit width method is considered to calculate nominal compression strength. This is a conservative approach to calculate the nominal compression strength, as the effect of end plates on the compression capacity is not considered. However, this simplified unit width method can be used for C-PSW/CFs with different configurations, for example, L-shaped, C-shaped, I-shaped walls. Selected unit width cross-section of L-shaped C-PSW/CF is shown. The nominal compression strength of L-shaped C-PSW/CFs is calculated.

Design Of C-PSW/CFs

Wall compression Strength:

- $S_{tie} = 12 \text{ in} = 1 \text{ ft}$ (Length of selected unit width)
- $L_{wall.total} = 48 \text{ ft}$ (Total length of two C-PSW/CFs)
- $P_{no} = 2t_p S_{tie} F_y + 0.85 f'_c (t_{sc} - 2t_p) S_{tie} = 1,518 \text{ kips}$ (ANSI/AISC 360-22)
- $P_e = \frac{\pi^2 E I_{eff.min}}{L_{cr}^2} = 1797 \text{ kips}$
- $\frac{P_{no}}{P_e} = 0.84 < 2.25$ (ANSI/AISC 360-22)
- $P_{n.c} = P_{no} \left(0.685 \frac{P_{no}}{P_e}\right) = 1,066 \text{ kips}$
- $P_{n.c.total} = P_{n.c} n_{unit-width} = (1,066 \text{ kips})(48) = 51,168 \text{ kips}$
- $\phi_C P_{n.c.total} = (0.9)(51,168 \text{ kips}) = 46,051 \text{ kips} > P = 20,644 \text{ kips}$
- $\frac{P}{\phi_C P_{n.c.total}} = 0.45$



FEMA

Building Seismic
Safety Council



A simplified unit width method is considered to calculate nominal compression strength. This is a conservative approach to calculate the nominal compression strength, as the effect of end plates on the compression capacity is not considered. However, this simplified unit width method can be used for C-PSW/CFs with different configurations, for example, L-shaped, C-shaped, I-shaped walls. Selected unit width cross-section of L-shaped C-PSW/CF is shown. The nominal compression strength of L-shaped C-PSW/CFs is calculated.

Design Of C-PSW/CFs (Flexural Strength)

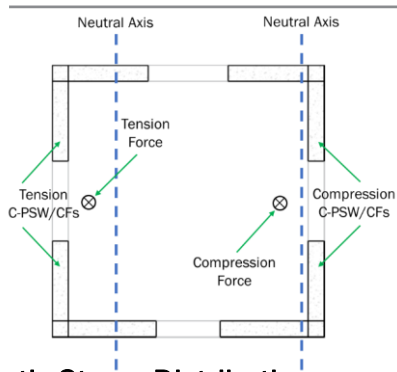

Plastic Stress Distribution:

$$M_{P.T.wall} = M_{n.T.wall} = 1,598,236 \text{ kip-in.}$$

$$M_{P.C.wall} = M_{n.C.wall} = 1,761,166 \text{ kip-in.}$$

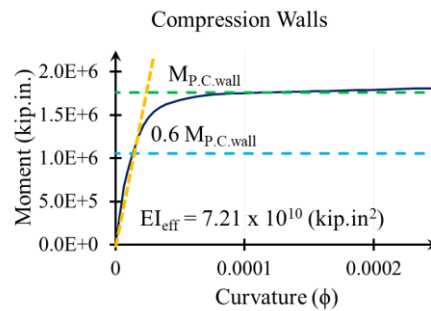
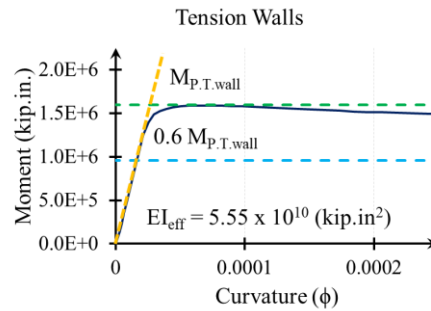

FEMA

Building Seismic
Safety Council



When the core system is subjected to lateral seismic forces, two L-shaped C-PSW-CFs are subjected in tension force and the other two L-shaped C-PSW-CFs are in compression. The flexural capacities of tension and compression L-shaped C-PSW-CFs are calculated using plastic stress distribution method, when they are subjected to -18365 kips compression and 6940 kips tension forces.

Design Of C-PSW/CFs (Flexural Strength)

The effective flexural stiffnesses of tension and compression ($EI_{T.wall}$ and $EI_{C.wall}$) L-shaped C-PSW/CFs are used to calculate required flexural strengths of tension and compression walls.

- $M_{U.T.wall} = \left[\frac{EI_{T.wall}}{(EI_{C.wall} + EI_{T.wall})} \right] M_{r.wall} = 652833 \text{ kip-in.} = 54403 \text{ kip-ft}$
- $M_{U.C.wall} = \left[\frac{EI_{C.wall}}{(EI_{C.wall} + EI_{T.wall})} \right] M_{r.wall} = 848094 \text{ kip-in.} = 70675 \text{ kip-ft}$

Ratio of demand to capacity:

- $\frac{M_{U.T.wall}}{\phi_t M_{n.T.wall}} = 0.45$
- $\frac{M_{U.C.wall}}{\phi_t M_{n.C.wall}} = 0.54$



FEMA

Building Seismic
Safety Council



The effective flexural stiffnesses of tension and compression ($EI_{T.wall}$ and $EI_{C.wall}$) L-shaped C-PSW/CFs are used to calculate required flexural strengths of tension and compression walls.

P-M Interaction of C-PSW/CFs

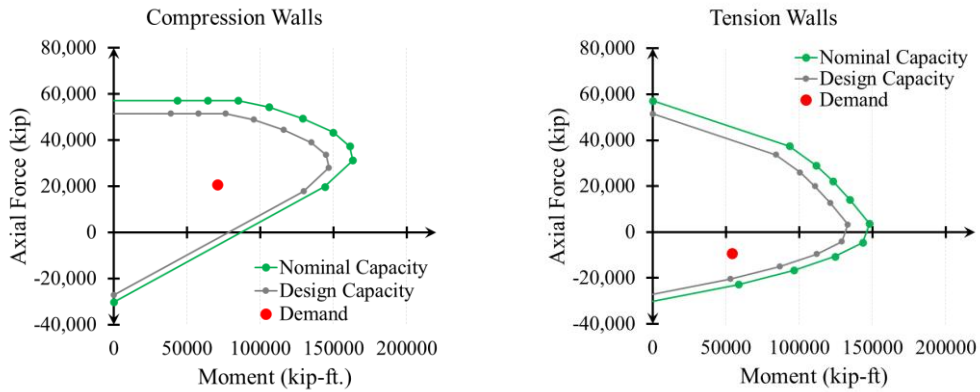

FEMA

Building Seismic
Safety Council



Alternatively, P-M interaction diagrams of tension and compression L-shaped C-PSW/CF can be developed and compared with required flexural and axial strengths. The figure shows P-M interaction diagrams of tension and compression L-shaped C-PSW/CFs. As shown in the figure, L-shaped C-PSW/CFs can clearly resist the required axial (tension or compression) and flexural loads.

Design Of C-PSW/CFs (Shear Strength)

Wall Shear Strength:

- $A_{s.wall} = 4(L_W t_p) + 2(t_{sc} t_p) = (4)(144)(0.5) + (2)(16)(0.5) = 304 \text{ in.}^2$
- $K_S = G_S A_{s.wall} = (11200)(304) = 3.39 \times 10^6 \text{ kips}$
- $K_{Sc} = \frac{0.7(E_c A_c)(E_s A_{s.wall})}{(4E_s A_{s.wall}) + (E_c A_c)} = 3.14 \times 10^6 \text{ kips}$
- $V_{n.wall} = \frac{K_S + K_{Sc}}{\sqrt{3K_S^2 + K_{Sc}^2}} A_{s.wall} F_y = 14906 \text{ kips}$
- $\phi_v V_{n.wall} = 13416 \text{ kips} > V_{U.wall} = 2476 \text{ kips}$
- $\frac{V_{U.wall}}{\phi_v V_{n.wall}} = 0.19$

Coupling Beam-to-Wall Connection

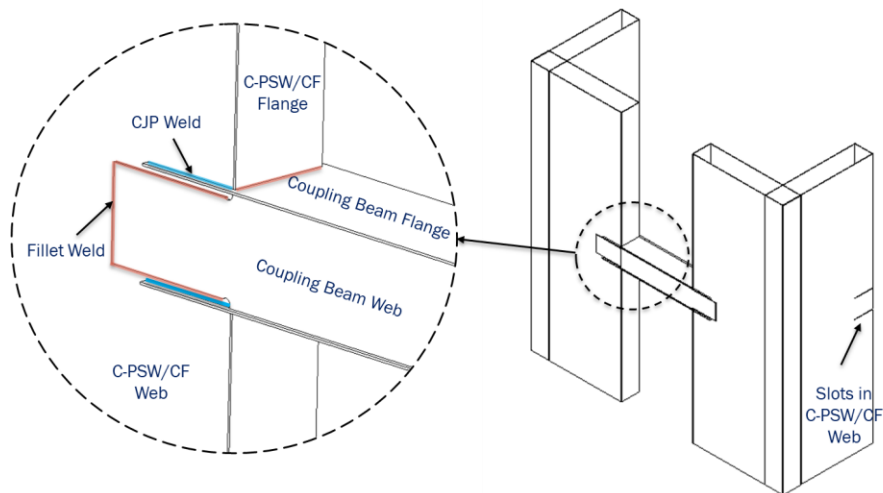

FEMA

Building Seismic
Safety Council



53

- As shown in the figure, there are slots in the C-PSW/CF web plates and coupling beam flange plates are inserted into the slots.
- Coupling beam flange plates are 1 in. wider than wall cross section from each side to provide adequate clearance for CJP welding.
- The slots of C-PSW/CF web plates are beveled and welded to the coupling beam flange plates using complete joint penetration (CJP) welding.
- The coupling beam web plates are overlapped the C-PSW/CF web plates and C-shaped fillet welding was done.
- The depth of coupling beam web plate is reduced 1 in. from top and bottom at the connection region to provide adequate clearance for fillet welding.

Coupling Beam-to-Wall Connection

- Coupling Beam-to-Wall Connection Details (scaled specimen)

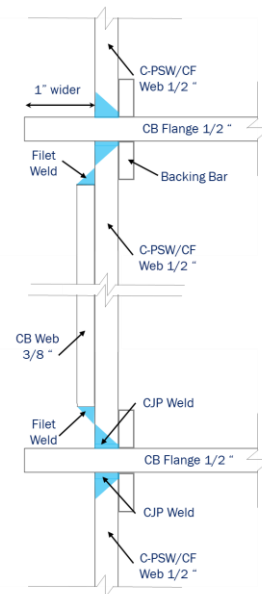

FEMA

Building Seismic
Safety Council



As shown in the figure, there are slots in the C-PSW/CF web plates and coupling beam flange plates are inserted into the slots. Coupling beam flange plates are 1 in. wider than wall cross section from each side to provide adequate clearance for welding. The slots of C-PSW/CF web plates are beveled and welded to the coupling beam flange plates using complete joint penetration (CJP) welding. The depth of coupling beam web plate is reduced 1 in. from top and bottom at the connection region to provide adequate clearance for fillet welding. The coupling beam web plates are lapped over the C-PSW/CF web plates and “C” shape fillet welding was done.

Coupling Beam-to-Wall Connection

- Coupling Beam-to-Wall Connection Details (scaled specimen)

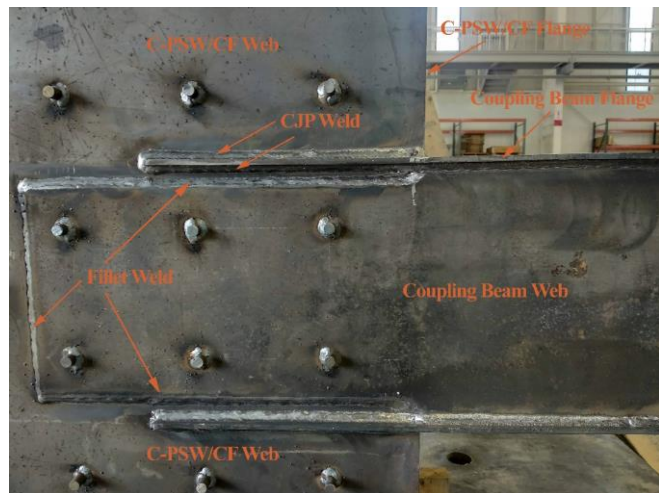

FEMA

Building Seismic
Safety Council



As shown in the figure, there are slots in the C-PSW/CF web plates and coupling beam flange plates are inserted into the slots. Coupling beam flange plates are 1 in. wider than wall cross section from each side to provide adequate clearance for welding. The slots of C-PSW/CF web plates are beveled and welded to the coupling beam flange plates using complete joint penetration (CJP) welding. The depth of coupling beam web plate is reduced 1 in. from top and bottom at the connection region to provide adequate clearance for fillet welding. The coupling beam web plates are lapped over the C-PSW/CF web plates and “C” shape fillet welding was done.

Coupling Beam-to-Wall Connection

Flange Plate Connection Demand:

- $T_{flange} = \min (1.2 R_y F_y A_{CB,f}, R_t F_u A_{CB,f}) = 594$ kips
- $\frac{T_{flange}}{2} = 297$ kips

Required Length of CJP Welding :

- $\frac{T_{flange}}{2} \leq \phi_d 0.6 F_y t_{CB,f} L_{req.}$ $\phi_d = 1.0$
- $L_{req.} \geq \frac{T_{flange}}{2(\phi_d 0.6 F_y t_{CB,f})} = \frac{594}{2(1.0)(0.6)(50)(0.5)} = 19.8$ in. $\phi_n = 0.9$
- $L_{weld.f} = 20$ in.



Check Shear Strength of Coupling Beam Flange Plate

Shear yielding of coupling beam flange plate:

- $A_{f.SY} = t_{CB.f} L_{weld.f} = (0.5)(20) = 10 \text{ in.}^2$
- $\phi_d 0.6 F_y A_{f.SY} = 300 \text{ kips} \geq \frac{T_{flange}}{2} = 297 \text{ kips}$

Shear rupture of coupling beam flange plate:

- $A_{f.SR} = t_{CB.f} L_{weld.f} = (0.5)(20) = 10 \text{ in.}^2$
- $\phi_n 0.6 F_u A_{f.SR} = 351 \text{ kips} > \frac{T_{flange}}{2} = 297 \text{ kips}$

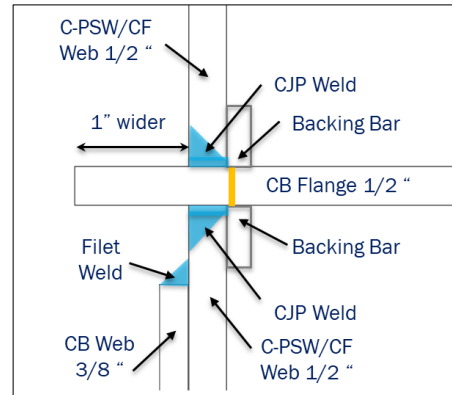

FEMA

Building Seismic
Safety Council



Shear yielding and shear rupture of coupling beam flange plate are calculated and compared with required strength of flange plate connection.

Check Shear Strength of Wall Web Plates

Shear yielding of wall web plates:

- $A_{w.SY} = 2 t_p L_{weld.f} = 2(0.5)(20) = 20 \text{ in.}^2$
- $\phi_d 0.6 F_y A_{w.SY} = 600 \text{ kips} > \frac{T_{flange}}{2} = 297 \text{ kips}$

Shear rupture of wall web plates:

- $A_{w.SR} = 2 t_p L_{weld.f} = 2(0.5)(20) = 20 \text{ in.}^2$
- $\phi_n 0.6 F_u A_{w.SR} = 702 \text{ kips} > \frac{T_{flange}}{2} = 297 \text{ kips}$

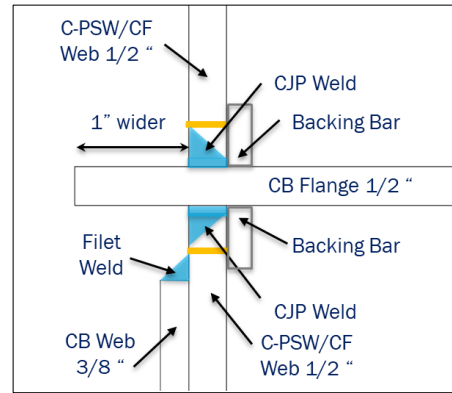

FEMA

Building Seismic
Safety Council



Shear yielding and shear rupture of C-PSW/CF web plate are calculated and compared with required strength of flange plate connection.

Check Ductile Behavior of Flange Plates

In coupling beam flange plate to C-PSW/CF connection design, the available tensile rupture strength should be higher than the available tensile yield strength.

- $A_{CB.f.g} = (b_{CB} + 2in.) t_{CB.f} = (16 + 2)(0.5) = 9 \text{ in.}^2$ (Gross area)
- $A_{CB.f.n} = b_{CB} t_{CB.f} = (16)(0.5) = 8 \text{ in.}^2$ (Net area)
- $R_y F_y A_{CB.f.g} = (1.1)(50)(9) = 495 \text{ kips}$ (Available tension yielding capacity)
- $R_t F_u A_{CB.f.n} = (1.2)(65)(8) = 624 \text{ kips}$ (Available tension rupture capacity)
- $R_t F_u A_{CB.f.n} = 624 \text{ kips} > R_y F_y A_{CB.f.g} = 495 \text{ kips}$



FEMA

Building Seismic
Safety Council



Shear yielding and shear rupture of C-PSW/CF web plate are calculated and compared with required strength of flange plate connection.

Calculate Forces in Web Plates

$T_{2.exp} = 773$ kips	(Expected tension force of CB web)
$C_{2.exp} = 217$ kips	(Expected compression force of CB web)
$C_{CB.exp} = 5.26$ in.	(Plastic neutral axis of CB considering $M_{CB,p.exp.}$)
$T_{web} = 1.2 (T_{2.exp} - C_{2.exp}) = 667$ kips	(CB web plates tension force)
$M_{web} = 1.2 \left(T_{2.exp} \frac{C_{CB.exp}}{2} + C_{2.exp} \frac{h_{CB} - C_{CB.exp}}{2} \right) = 407$ kip-ft	(CB web plates moment)
$V_{web} = 2 \left(\frac{1.2 M_{p.exp.CB}}{L_{CB}} \right) = 380$ kips	(CB web plates shear force)



FEMA

Building Seismic
Safety Council



In coupling beam web plate to C-PSW/CF connection design, axial tension, shear force, and moment of coupling beam web plates are calculated.

Calculate Force Demand on C-Shaped Weld

$$T_{C.weld} = \frac{T_{web}}{2} = 333 \text{ kips}$$

$$M_{C.weld} = \frac{M_{web}}{2} = 203 \text{ kip-ft}$$

$$V_{C.weld} = \frac{V_{web}}{2} = 190 \text{ kips}$$

$$D_{min} = 3/16 \text{ in.}$$

$$D_{max} = 5/16 \text{ in.}$$

$$D = 5/16 \text{ in.}$$

$$D_{min} \leq D \leq D_{max}$$

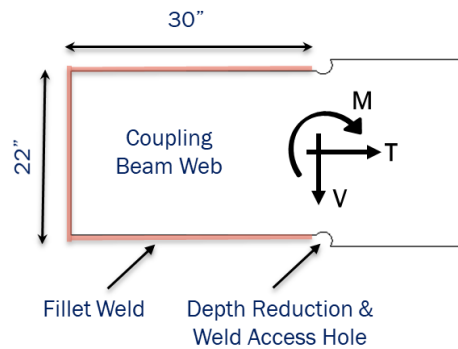

FEMA

Building Seismic
Safety Council



Required forces for the design of "C" shape fillet weld are

Calculate Capacity of C-Shaped Weld

$$Eccentricity = \frac{M_{C.web}}{V_{C.web}} = 12.85 \text{ in.}$$

$$c.g. = \frac{L_{H.weld.w}^2}{2L_{H.weld.w} + L_{V.weld.w}} = \frac{30^2}{2(36) + (22)} = 10.98 \text{ in.}$$

$$e_x = Eccentricity + (L_{H.weld.w} - c.g.) = 31.88 \text{ in.}$$

$$k = \frac{L_{H.weld.w}}{L_{V.weld.w}} = \frac{30}{22} = 1.36 \quad (\text{AISC Steel Manual 15}^{\text{th}} \text{ Edition Table 8-8})$$

$$a = \frac{e_x}{L_{V.weld.w}} = \frac{11}{22} = 1.45$$

$$P_{V.weld} = \phi_n C_{8.8} C_{1-8.3} (16D) L_{V.weld.w}$$

$$P_{V.weld} = 334 \text{ kips} > V_{C.weld} = 190 \text{ kips}$$

$$\frac{V_{C.weld}}{P_{V.weld}} = 0.62$$

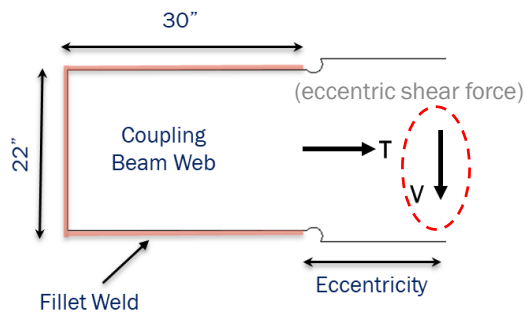

FEMA

Building Seismic
Safety Council



Calculate Capacity of C-Shaped Weld

$$P_{T.weld} = \phi_n 0.6 F_{XX} 2 L_{H.weld.w} 0.7071D = (0.9)(0.6)(70)[2(30)](0.7071)(5/16)$$

$$P_{T.weld} = 501 \text{ kips} > T_{C.weld} = 333 \text{ kips}$$

$$\frac{T_{C.weld}}{P_{T.weld}} = 0.67$$

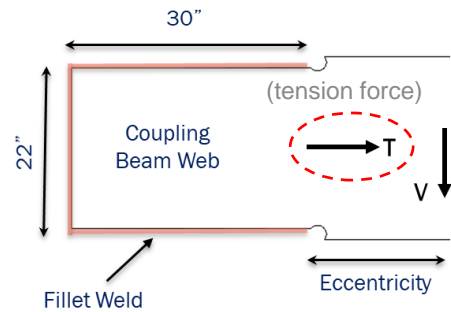

$$Capacity = \sqrt{\left(\frac{V_{C.weld}}{P_{V.weld}}\right)^2 + \left(\frac{T_{C.weld}}{P_{T.weld}}\right)^2} = \sqrt{(0.64)^2 + (0.67)^2} = 0.91 \leq 1$$



FEMA

Building Seismic
Safety Council



Questions



FEMA



Building Seismic
Safety Council



This slide is intended to initiate questions from participants.

DISCLAIMER

- NOTICE: Any opinions, findings, conclusions, or recommendations expressed in this publication do not necessarily reflect the views of the Federal Emergency Management Agency. Additionally, neither FEMA, nor any of its employees make any warranty, expressed or implied, nor assume any legal liability or responsibility for the accuracy, completeness, or usefulness of any information, product or process included in this publication.
- The opinions expressed herein regarding the requirements of the *NEHRP Recommended Seismic Provisions*, the referenced standards, and the building codes are not to be used for design purposes. Rather the user should consult the jurisdiction's building official who has the authority to render interpretation of the code.
- This training material presentation is intended to remain complete in its entirety even if used by other presenters. While the training material could be tailored for use in other presentations, we caution users to account for issues of completeness and interpretation if only part of the material is used. We also strongly suggest users give proper credit/citation to this presentation and its authors.



FEMA

 Building Seismic
Safety Council



Chapter 6 Cross-Laminated Timber (CLT) Shear Walls

2020 NEHRP Provisions Training Materials

Philip Line, PE, American Wood Council

M. Omar Amini, PhD, Simpson Strong-Tie



FEMA



Building Seismic
Safety Council

BSSC



6.1 Overview - Cross-Laminated Timber (CLT) Shear Wall Example

- This example features the seismic design of cross-laminated timber shear walls used in a three-story, six-unit townhouse cross-laminated timber building of platform construction
- The CLT shear wall design in this example includes:
 - Check of CLT shear wall shear strength
 - Check of CLT shear wall hold-down size and compression zone length for overturning
 - Check of CLT shear wall deflection for conformance to seismic drift

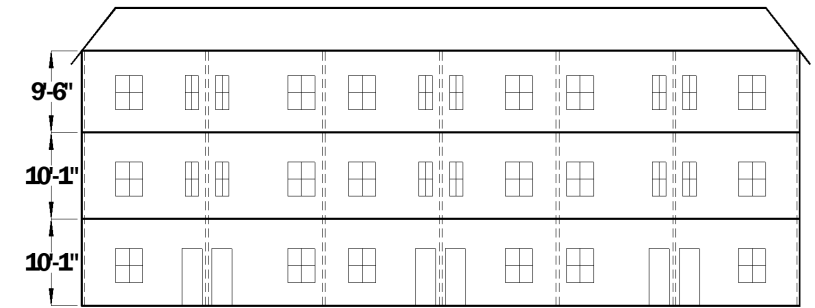

Figure 6-2. Elevation

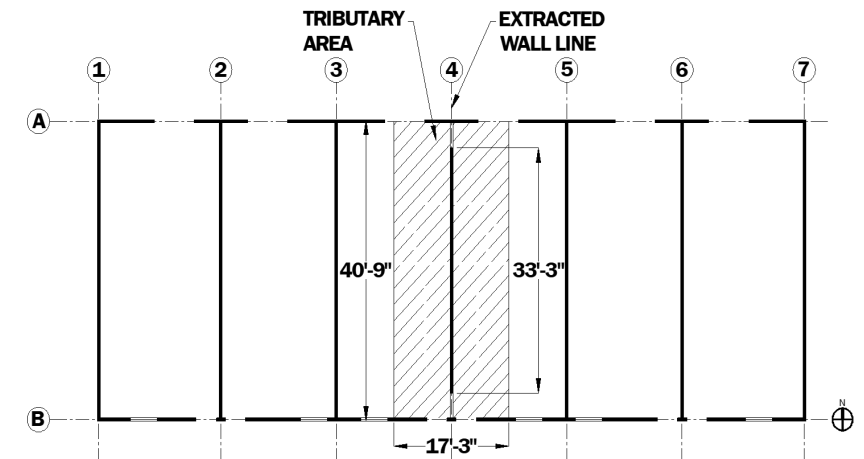

Figure 6-3. Typical Floor Plan (first story openings shown)



FEMA



Building Seismic
Safety Council



6.1 Overview - Useful Design Aid Resources

- The following documents are used in this example
 - APA, 2020. *Standard for Performance-Rated Cross-Laminated Timber*, ANSI/APA PRG 320-19, APA, 2020
 - ASCE/SEI 7-22, *Minimum Design Loads and Associated Criteria for Buildings and Other Structures*
 - AWC, 2020. *Special Design Provisions for Wind and Seismic (SDPWS)*, SDPWS-21, American Wood Council
 - AWC, 2017. *National Design Specification (NDS) for Wood Construction*, NDS-18, American Wood Council, Leesburg, VA, 2017
 - FEMA, 2020a. *NEHRP Recommended Seismic Provisions for New Buildings and Other Structures, Volume I: Part 1 Provisions and Part 2 Commentary*, 2020 Edition, FEMA P-2082-1, prepared by the Building Seismic Safety Council of the National Institute of Building Sciences for Federal Emergency Management Agency



FEMA



Building Seismic
Safety Council



6.2 Background

- NEHRP (2020a) proposed additions for ASCE/SEI 7-22 Table 12.2-1 featuring cross-laminated timber (CLT) shear walls

Seismic Force-Resisting System	Detailing Requirements, ASCE/SEI 7-22 Section	R	Ω_0	C_d	Structural System Limitations Including Structural Height, h_n (ft) Limits ^d				
					Seismic Design Category				
					B	C	D	E	F
A. BEARING WALL SYSTEMS									
Cross laminated timber shear walls	14.5	3	3	3	65	65	65	65	65
Cross laminated timber shear walls with shear resistance provided by high aspect ratio panels only	14.5	4	3	4	65	65	65	65	65



FEMA



Building Seismic Safety Council



6.2 Background

- Cross-laminated timber (CLT)
 - Usually 3, 5 or 7 layers of dimension lumber stacked in alternating directions and bonded together with adhesive
 - Research and development for CLT began in the early 1990s in Europe
 - The first production facilities established in 1994 in Austria, Germany and Switzerland
 - The term coined in 2000 at the COST E5 conference in Italy

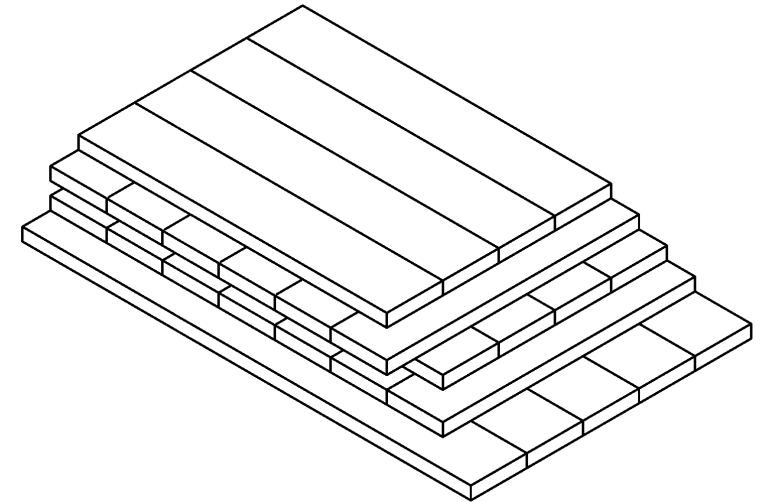

CLT panel with layers stacked in alternating (crossing) directions



FEMA



Building Seismic
Safety Council



6.2 Background

- Cross-laminated timber (CLT)
 - Stadthaus, London, 2009
 - Residential
 - 9 stories
 - 9 weeks of CLT construction
 - 4 laborers
 - 1 supervisor



Photo credit: Will Pryce



FEMA



Building Seismic
Safety Council



6.2 Background



Photo credit: Will Pryce



FEMA



Building Seismic
Safety Council



6.2 Background



Photo credit: Will Pryce



FEMA

Building Seismic Safety Council



6.2 Background



Ft. Drum, NY (4-story), 2017; Courtesy Jeff Morrow, Lendlease



FEMA

Building Seismic
Safety Council



6.2 Background

- FEMA P695, *Quantification of Building Seismic Performance Factors*
 - Peer review throughout
 - Archetypes
 - Design methodology
 - Nonlinear time history analysis
 - Performance evaluation (CMR & ACMR)
- Project Documentation: van de Lindt, J., Rammer, D., Amini, M. O., Line, P., Pei, S., and Popovski, M., 2021. “Determination of Seismic Performance Factors for Cross-Laminated Timber Shear Walls Based on the FEMA P695 Methodology,” General Technical Report FPL-GTR-281, Madison, WI: U.S. Department of Agriculture, Forest Service, Forest Products Laboratory, (in press).

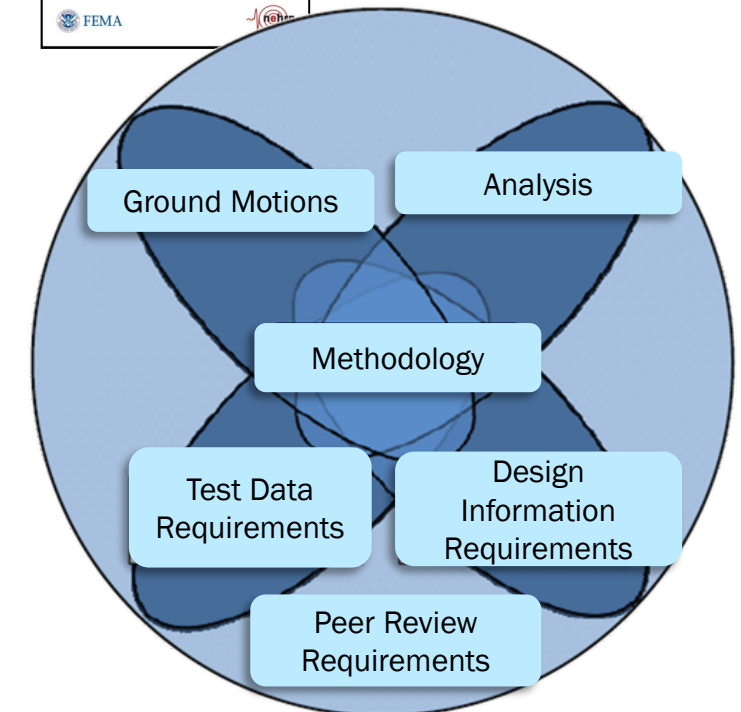
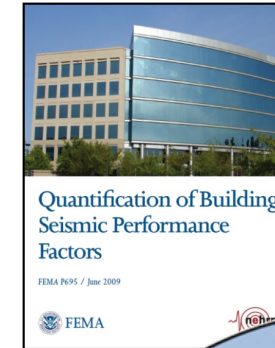

FEMA



Building Seismic
Safety Council



6.2 Background

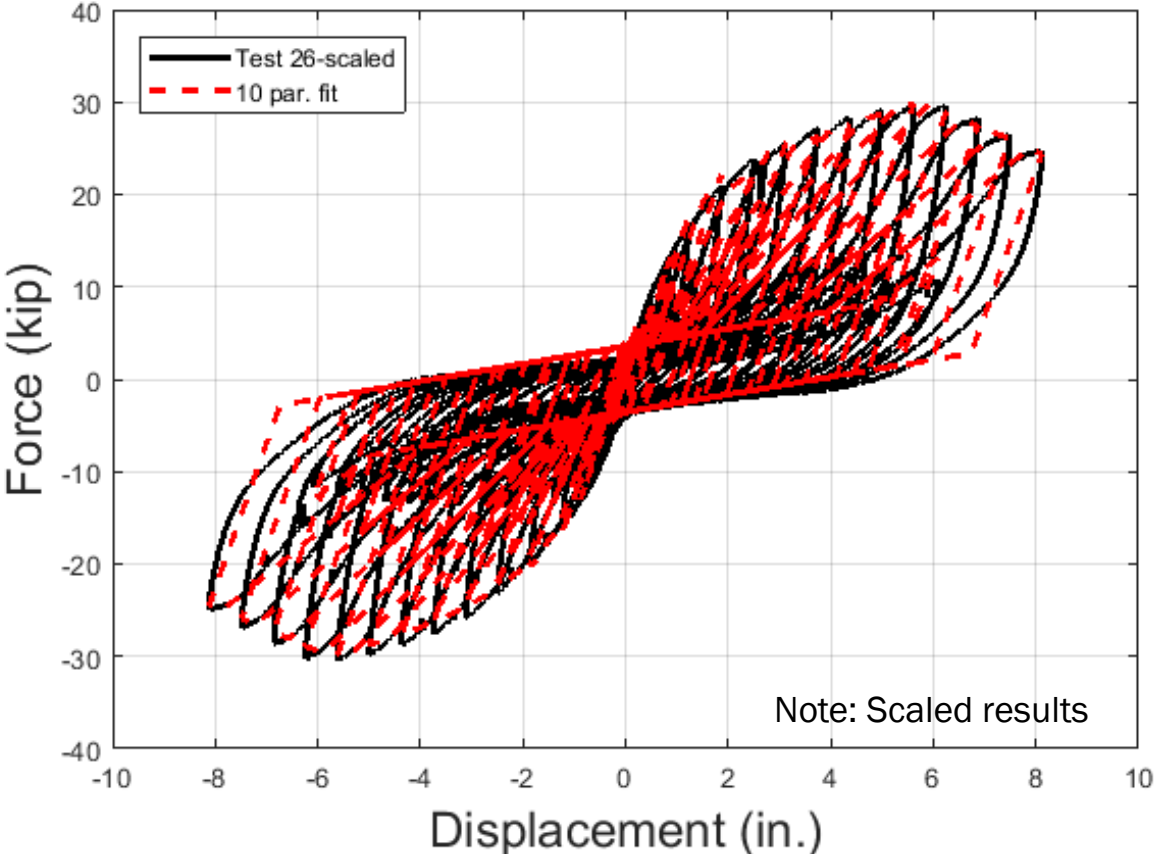

6.2 Background



FEMA

Building Seismic Safety Council



6.2 Background



FEMA

Building Seismic
Safety Council



6.2 Background

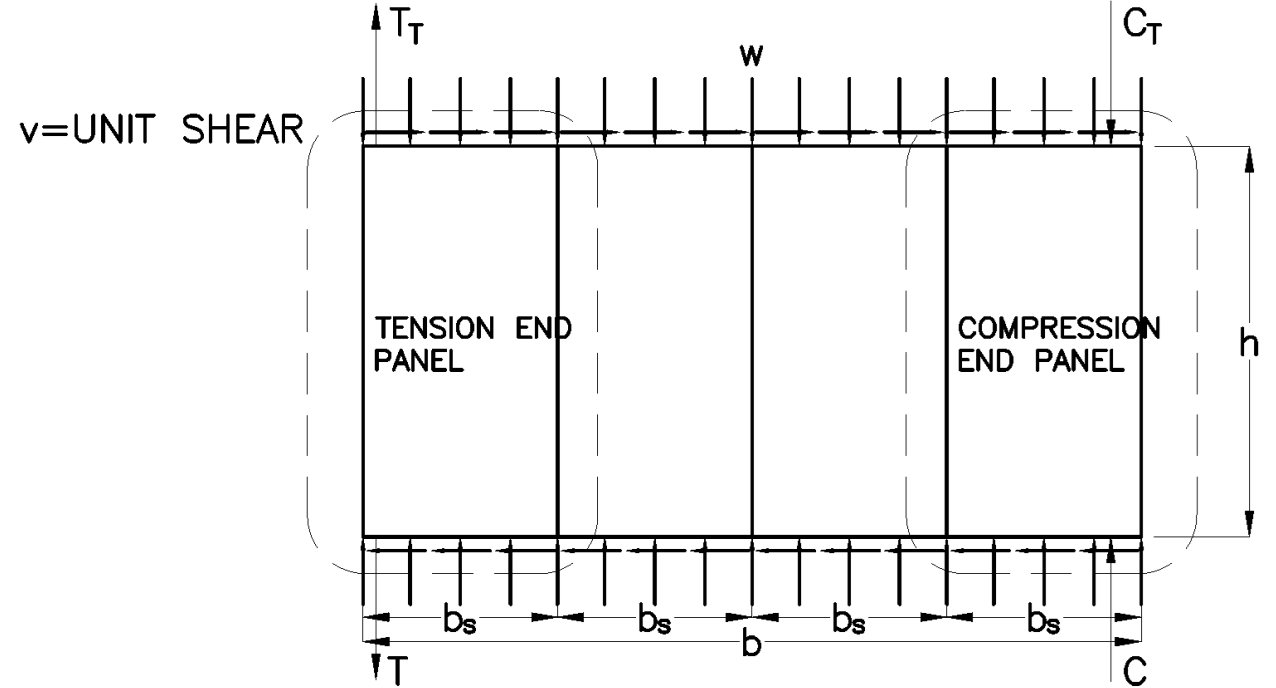
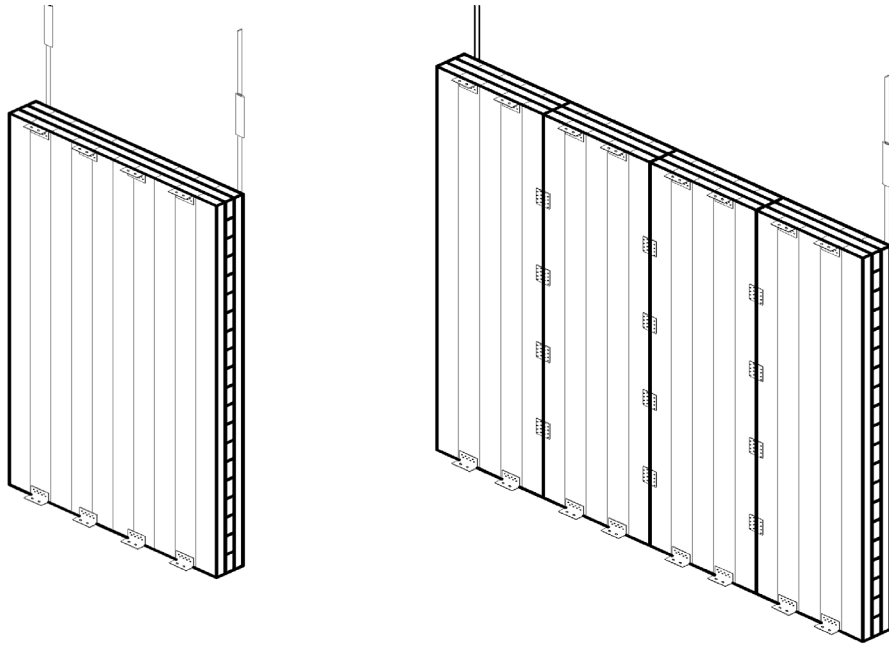

FEMA



Building Seismic
Safety Council



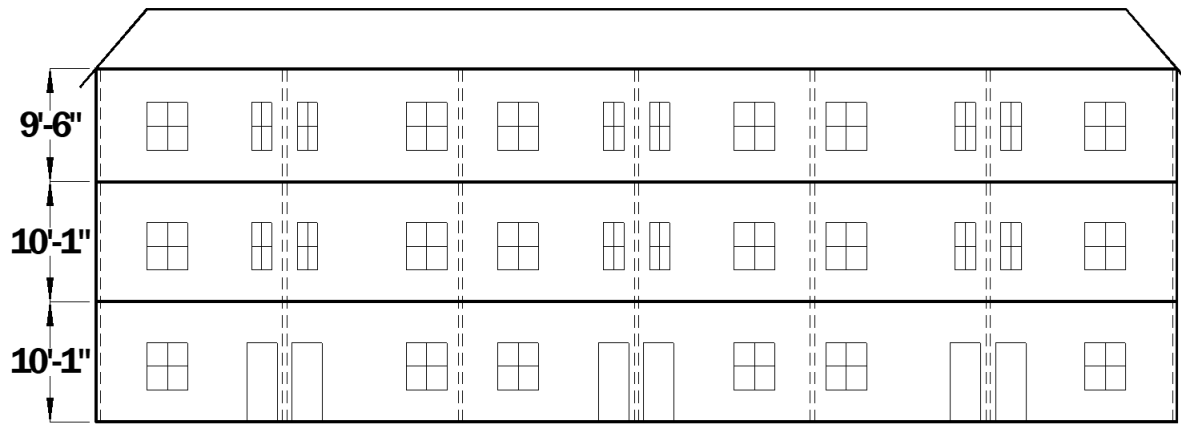

Figure 6-2. Elevation

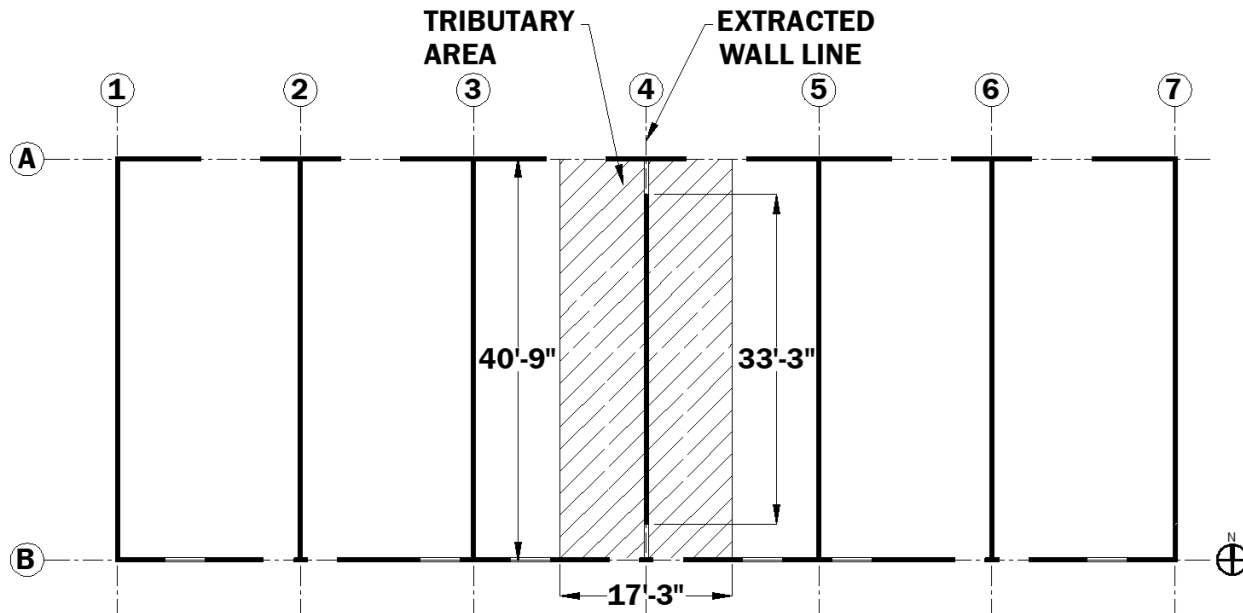

Figure 6-3. Typical Floor Plan (first story openings shown)

6.3 Cross-Laminated Timber Shear Wall Example Description

- A three-story, six-unit townhouse cross-laminated timber building of platform construction
- The CLT shear wall design in this example includes:
 - Check of CLT shear wall shear strength
 - Check of CLT shear wall hold-down size and compression zone length for overturning
 - Check of CLT shear wall deflection for conformance to seismic drift



FEMA



Building Seismic Safety Council



6.3 Cross-Laminated Timber Shear Wall Example Description

Table 6-1: Weights of Roof/Ceiling, Floors, and Walls

Item	Description	Weight
Roof/Ceiling	Light-frame roof, gypsum board ceiling, roofing, insulation	25 psf
Floor	5-layer CLT (6.875 in. thick), gypsum board ceiling, flooring. Includes 8 psf of floor area for wall partitions	35 psf
Interior Walls	3-layer CLT (4.125 in. thick), light-frame wall, gypsum board finish, sound insulation	20 psf
Exterior Walls	3-layer CLT (4.125 in. thick), light-frame wall, gypsum board interior finish, stucco exterior, insulation	30 psf



6.3 Cross-Laminated Timber Shear Wall Example Description

Table 6-3: Design Coefficients and Factors for CLT Seismic Force-Resisting Systems (ASCE/SEI 7-22)

Seismic Force-Resisting System	Detailing Requirements, ASCE/SEI 7-22 Section	R	Ω_0	C_d	Structural Height, h_n , Limit Seismic Design Category B, C, D, E & F
Cross-laminated timber shear walls	14.5	3	3	3	65 feet
Cross-laminated timber shear walls with shear resistance provided by high aspect ratio panels only	14.5	4	3	4	65 feet



FEMA



Building Seismic Safety Council



6.4 Seismic Forces

- Seismic base shear calculation assumptions:
 - $S_{DS} = 1.0$
 - $I_e = 1.0$
 - $R = 3$ (for *CLT shear walls*)
- Seismic base shear, V , per ASCE/SEI 7-22 Equation 12.8-2 (for short-period structures):

$$V = C_s W = \frac{S_{DS}}{(R/I)} W = \frac{1.0}{(3.0/1.0)} W = 0.333 W \text{ kips}$$

- The portion of base shear tributary to the CLT shear walls of interest is:

$$V_{(\text{Line 4})} = 42.3 \text{ kips}$$



FEMA



Building Seismic
Safety Council



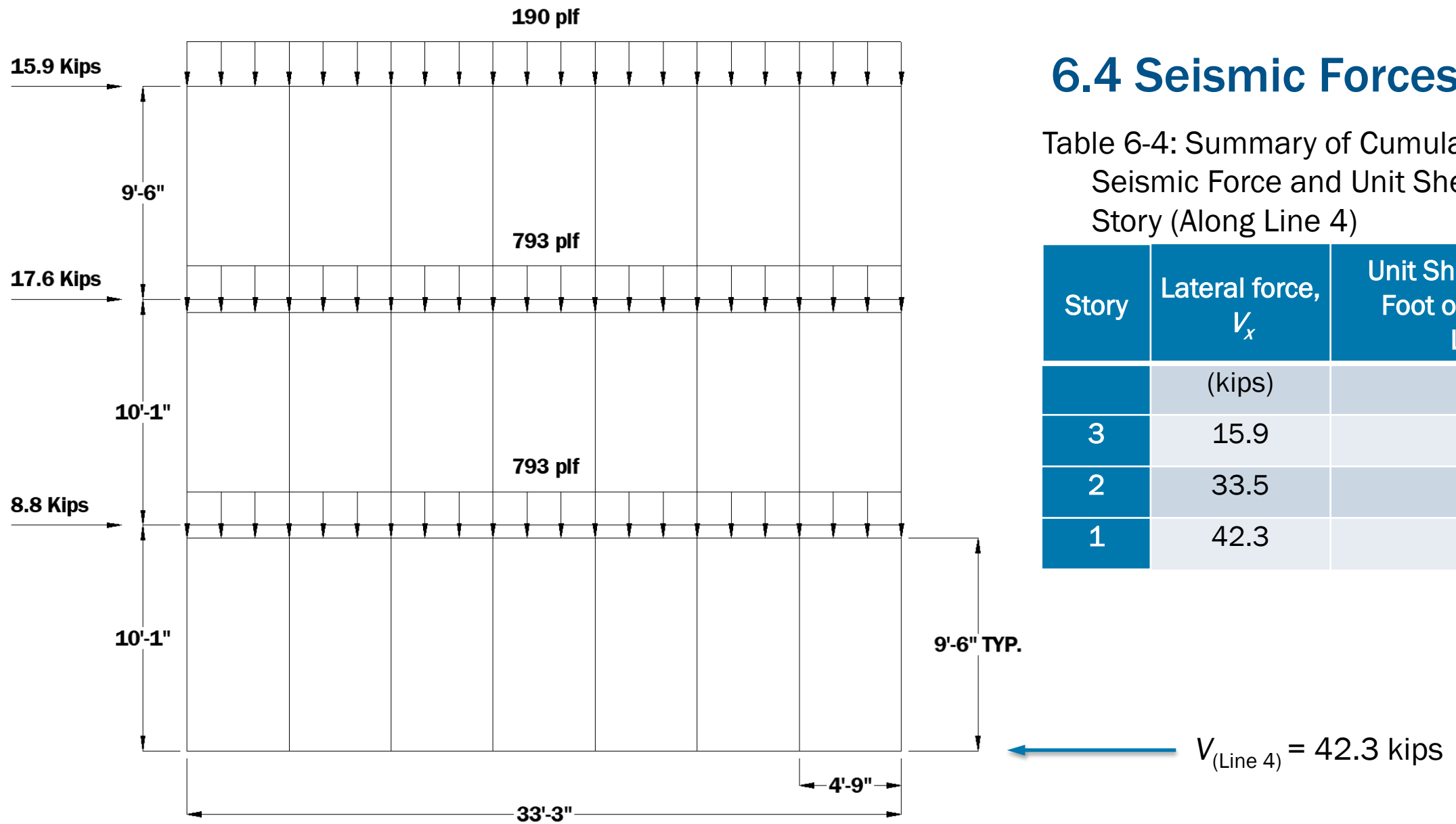

6.4 Seismic Forces

Table 6-4: Summary of Cumulative Lateral Seismic Force and Unit Shear Force per Story (Along Line 4)

Story	Lateral force, V_x	Unit Shear Force per Foot of Shear Wall Length
	(kips)	(plf)
3	15.9	477
2	33.5	1,009
1	42.3	1,273

Figure 6-4. Vertical Distribution of Seismic Force and Dead Load Tributary to the CLT Shear Walls Located Along Line 4

6.5.1 Shear Capacity of Prescribed Connectors

- LRFD design unit shear capacity for seismic:

$$v_{s(\text{seismic})} = \phi(n) \left(\frac{2605}{b_s} \right) C_G \quad (\text{SDPWS-21 Eq. B.5})$$

where:

n = number of angle connectors along bottom of panel face

2,605 = connector nominal shear capacity (lb)

b_s = individual CLT panel length (ft)

C_G = CLT panel specific gravity factor which equals 1.0 for $G \geq 0.42$ specific gravity panels used in this example, and

ϕ = resistance factor equal to 0.5 for seismic design

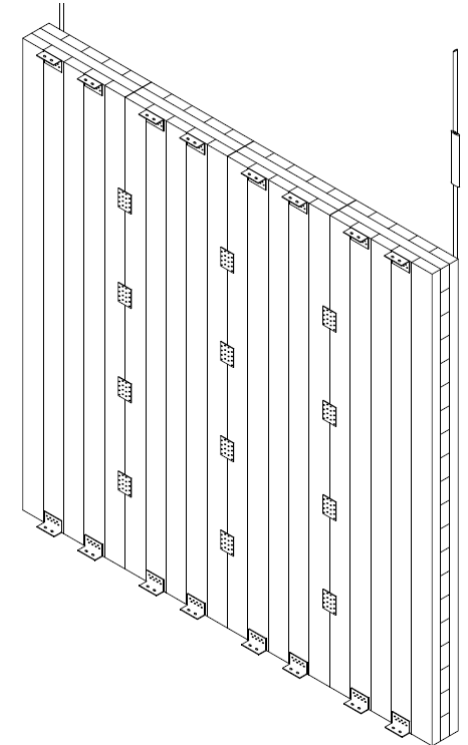

From SDPWS Figure C-B.1



FEMA



Building Seismic
Safety Council



6.5.1 Shear Capacity of Prescribed Connectors

Table 6-5: CLT Shear Wall Connectors and LRFD Design Unit Shear Capacity

Story	Panel thickness	Panel length, b_s	Panel height, h	Number of connectors per panel at top and bottom panel edge	Number of connectors at each adjoining vertical panel edge	V_n Nominal unit shear capacity, (n·2605)/ b_s	$V_{s(seismic)}$ LRFD design unit shear capacity, ($\phi=0.5$)
	(in.)	(ft)	(ft)	(n)	(n x h/ b_s)	(plf)	(plf)
3	4.125	4.75	9.5	2	4	1,096	548
2	4.125	4.75	9.5	4	8	2,193	1,097
1	4.125	4.75	9.5	5	10	2,742	1,371



6.5.1 Shear Capacity of Prescribed Connectors

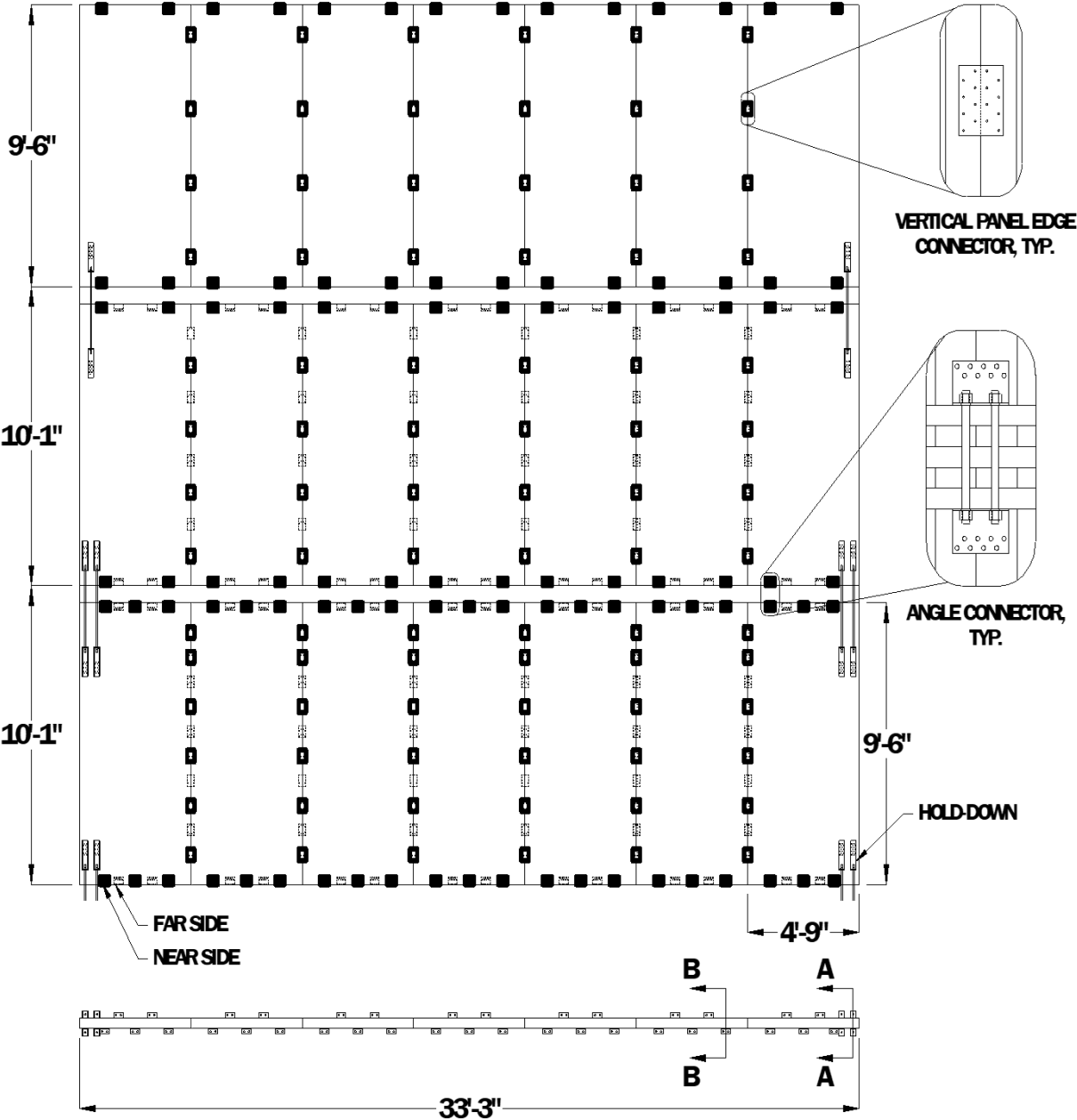
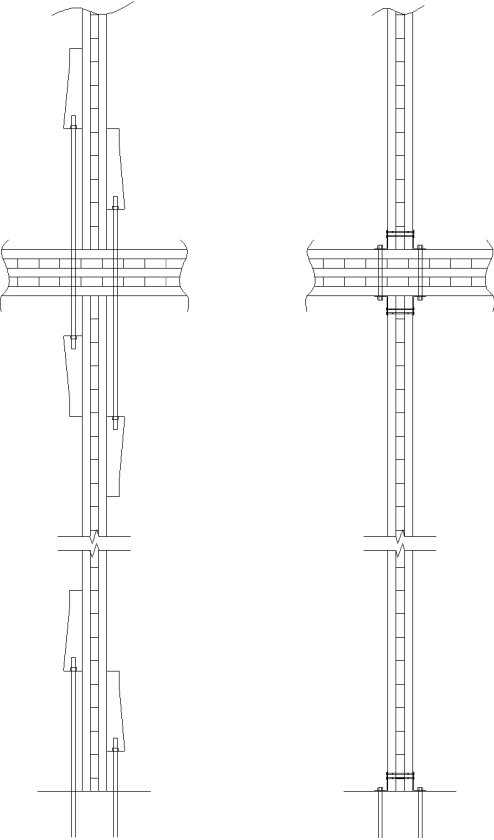

Figure 6-5. CLT Shear Walls at 1st, 2nd, and 3rd Story with Connector And Hold-down Location



SECTION A-A

SECTION B-B

Figure 6-6. Wall-floor Intersections

6.5.2 Shear Capacity of CLT Panel

- For this 3-layer E1 grade CLT panel, the allowable stress design (ASD) in-plane shear unit shear capacity is converted to LRFD using NDS-2018 Table 10.3.1:

$$v_r' = \phi \lambda K_F F_v(t_v) = 0.75(1.0)(2.88)(9,700) = 20,849 \text{ plf}$$

where:

$$F_v(t_v) = 9,700 \text{ plf (ASD value from CLT panel manufacturer's evaluation report)}$$

- CLT panel in-plane unit shear capacity, $v_r' = 20,849 \text{ plf}$ is greater than the largest unit shear force story demand of 1,273 plf (from Table 6-4)

$$20,849 \text{ plf} \gg 1,273 \text{ plf}$$

- In-plane unit shear capacity value does not account for holes, cuts or other modifications



FEMA



Building Seismic
Safety Council



6.6.1 CLT Shear Wall Hold-down Design

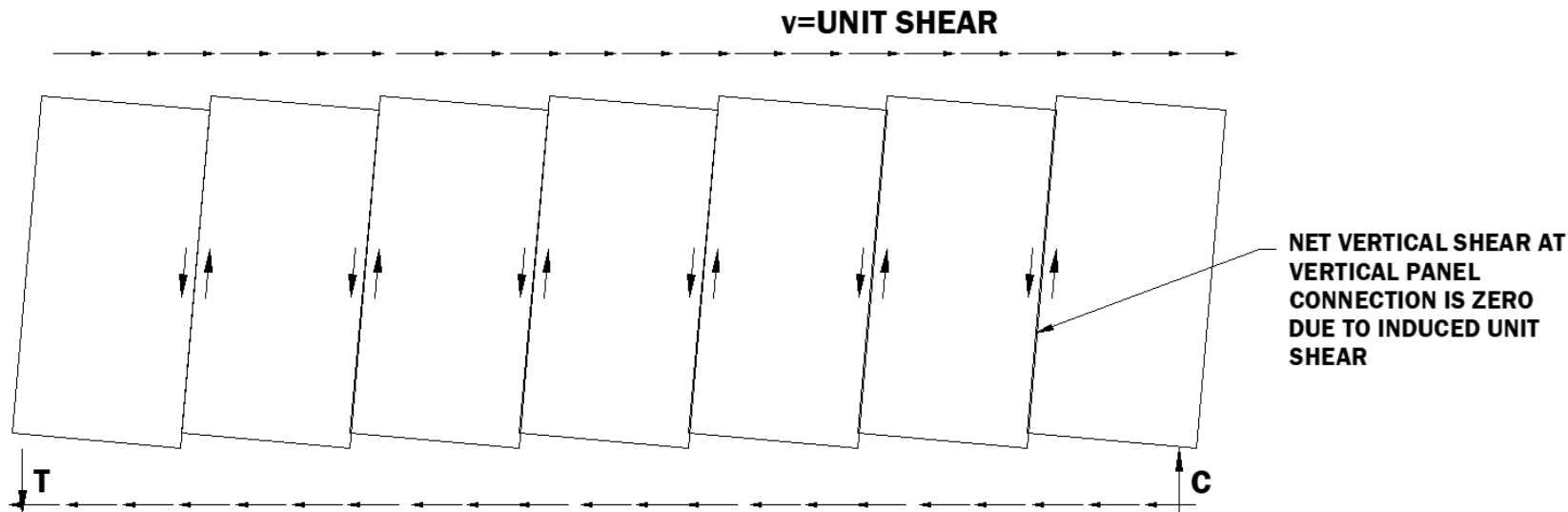

Figure 6-1. Illustration of Rocking Behavior of Seven Individual Panels in A Multi-panel CLT Shear Wall Designed in Accordance with SDPWS-21 Appendix B

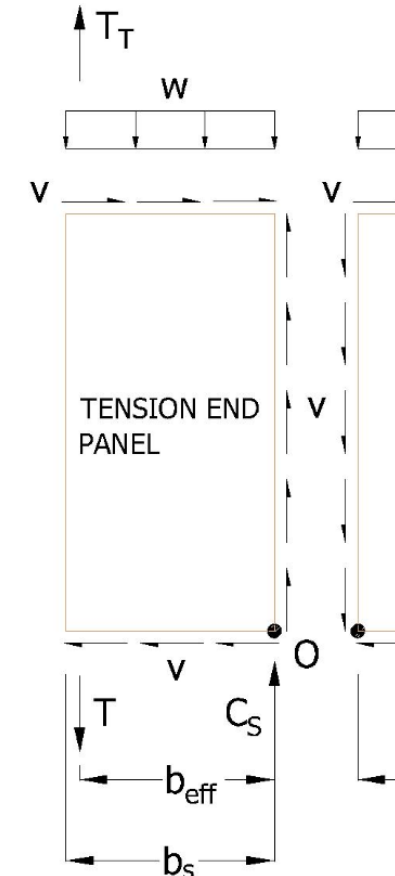

Figure 6-7. Free-body Diagram for the Tension End Panel of the CLT Multi-panel Shear Wall

6.6.1 CLT Shear Wall Hold-down Design

- $\sum M_o = 0$

$$T(b_{eff}) - vb_s h + wb_s \left(\frac{b_s}{2}\right) - T_T(b_{eff}) = 0 \quad (\text{SDPWS-21 Eq. C-B.1})$$

$$T = \frac{vb_s h - wb_s \left(\frac{b_s}{2}\right)}{b_{eff}} + T_T \quad (\text{SDPWS-21 Eq. C-B.2})$$

Table 6-6: Solution for Tension Force, T, for Hold-down Strength Requirement

Story	Unit shear force per foot of shear wall length	$V_{s(seismic)}$ LRFD design unit shear capacity, ($\phi = 0.5$)	2 x $V_{s(seismic)}$	T_T from story above	T for 2 x $V_{s(seismic)}$ requirement for load combination 1.0E - 0.7D
	(plf)	(plf)	(plf)	(lb)	(lb)
3	477	548	1,097	0	11,293
2	1,009	1,097	2,194	11,293	34,540
1	1,273	1,371	2,742	34,540	63,968

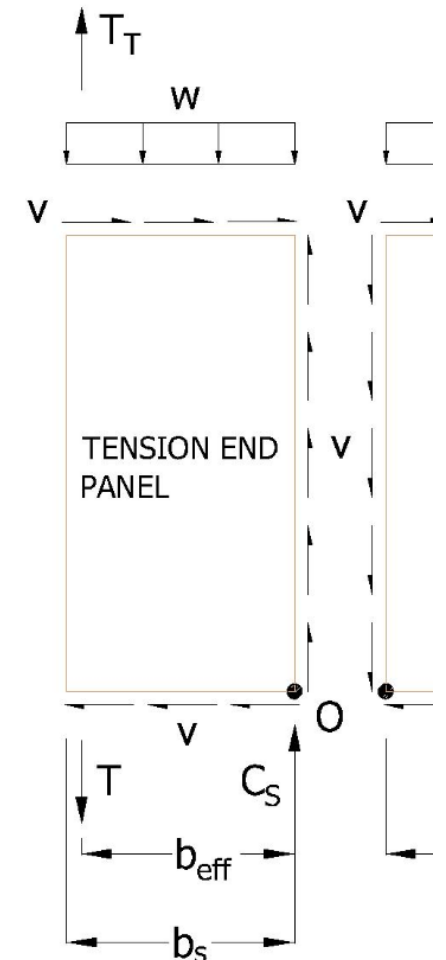

FEMA



Building Seismic Safety Council



6.6.1 CLT Shear Wall Hold-down Design

- The same screw attached hold-down is used for all locations with each having an LRFD design tension capacity of 17,678 lb and associated deflection of 0.253 in.
 - 1st story walls to foundation, four hold-downs
 $4 \times 17,687 \text{ lb} = 70,748 \text{ lb} > 63,968 \text{ lbs}$
 - 2nd story to top of 1st story, four hold-downs
 $4 \times 17,687 \text{ lb} = 70,748 \text{ lb} > 34,540 \text{ lbs}$
 - 3rd story to top of 2nd story, two hold-downs
 $2 \times 17,687 \text{ lb} = 37,374 \text{ lb} > 11,293 \text{ lbs}$
- Check CLT panel for tension, row and group tear out

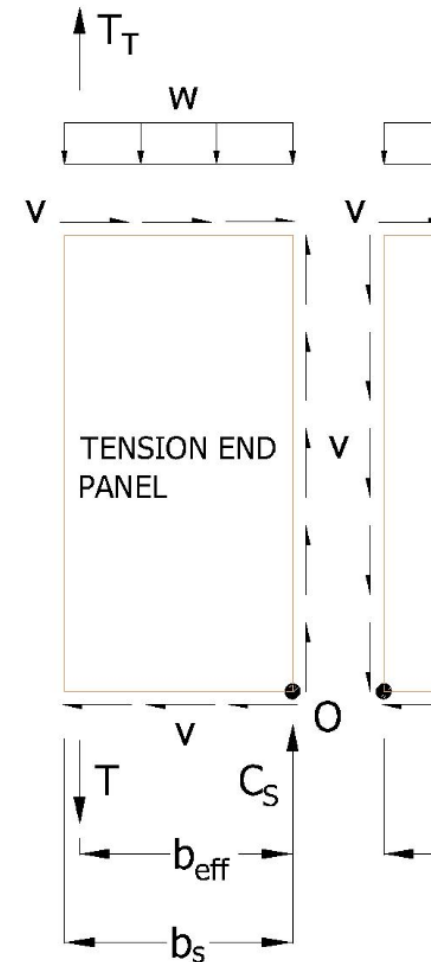

FEMA



Building Seismic
Safety Council



6.6.1 CLT Shear Wall Hold-down Design

- From SDPWS-21 Section B.3.4, hold-down device deformation for each story shall not exceed 0.185 in. for T forces from strength design load combinations (see Table 6-7)

Table 6-7: Solution for Tension Force, T, for Hold-down Deflection Requirement

Story	Unit shear force per foot of shear wall length	T for load combination
	(plf)	1.0E - 0.7D (lb)
3	477	4,714
2	1,009	14,604
1	1,273	27,472

- Deflection of most highly loaded hold-down is less than 0.185 in. The SDPWS-21 deflection limit is satisfied

$$\Delta_{hold-down} = \frac{27,472 \text{ lb}}{4(17,678 \text{ lb})} (0.253 \text{ in.}) = 0.098 \text{ in.} < 0.185 \text{ in.}$$

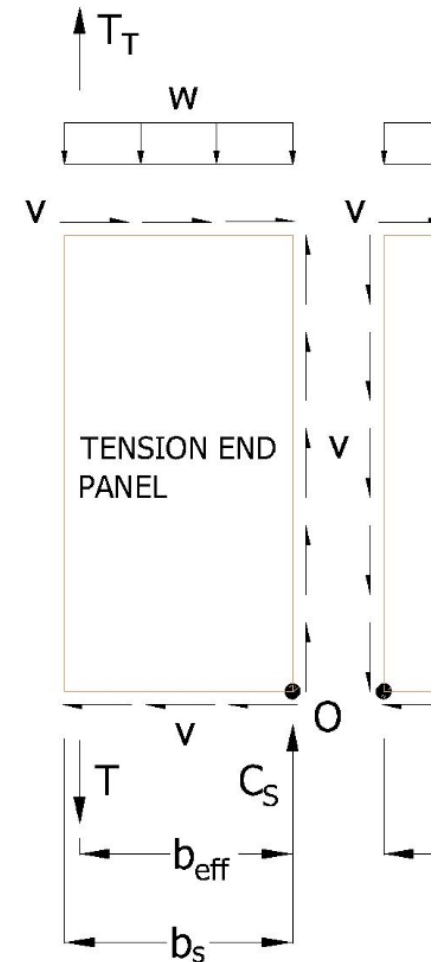

FEMA



Building Seismic
Safety Council



6.6.2 CLT Shear Wall Compression Zone

- Compression force, C , and length of compression zone, x , from compression end panel moment equilibrium

- $\sum M_o = 0$

$$C \left(b_s - \frac{x}{2} \right) - v b_s h - w b_s \left(\frac{b_s}{2} \right) - C_T \left(b_s - \frac{x_T}{2} \right) = 0 \quad (\text{SDPWS-21 Eq. C-B.3})$$

$$C = F_{C\perp}'(t)(x) \left(\frac{12 \text{ in.}}{\text{ft}} \right) \quad (\text{SDPWS-21 Eq. C-B.4})$$

$$C = F_{C'}(t_{\text{parallel}})(x) \left(\frac{12 \text{ in.}}{\text{ft}} \right) \quad (\text{SDPWS-21 Eq. C-B.5})$$

- C and x summarized in Table 6-8

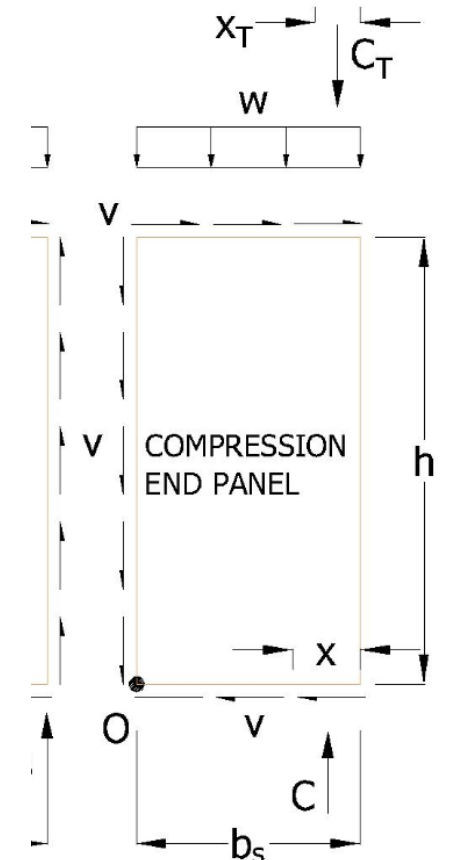

Figure 6-8. Free-body Diagram for the Compression End Panel of the CLT Multi-panel Shear Wall

6.6.2 CLT Shear Wall Compression Zone

Table 6-8: Solution for Compression Zone Length, x , and Force C

Story	Unit shear force per foot of shear wall length	Dead load, W_{DL}	Live load, W_{LL}	C_T Compression from top	Compression zone length, x	C , for load combination $1.0E + 1.4D + 0.5L$
	(plf)	(plf)	(plf)	(lb)	(in.)	(lb)
3	477	190	0	0	2.00	5,257
2	1,009	793	690	5,257	7.64	20,144
1	1,273	793	690	20,144	4.56	36,545

- Check of CLT wall panel axial capacity is required

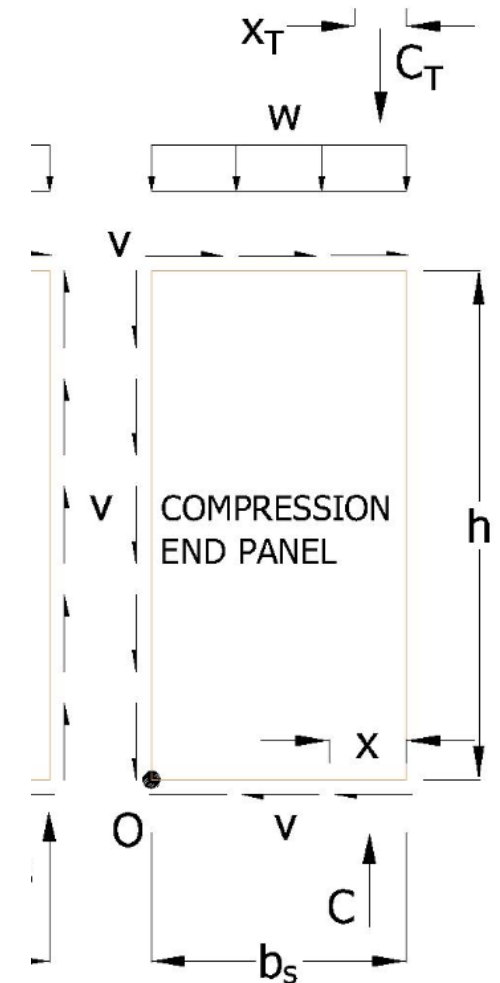

FEMA



Building Seismic Safety Council



6.7 CLT Shear Wall Deflection

$$\delta_{SW} = \frac{576vb_s h^3}{EI_{eff(in-plane)}} + \frac{vh}{GA_{eff(in-plane)}} + 3\Delta_{nail\ slip,h} + 2\Delta_{nail\ slip,v} \left(\frac{h}{b_s}\right) + \Delta_a \frac{h}{\sum b_s}$$

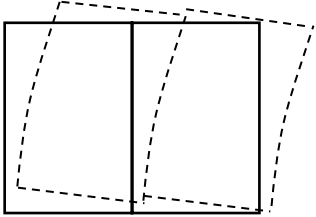
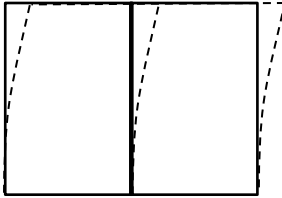
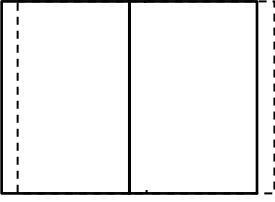
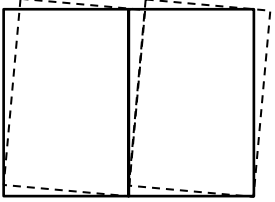
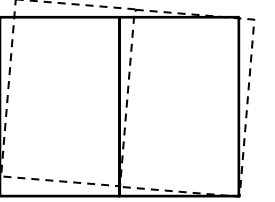
Total shear wall = deflection, δ_{SW}	Panel bending and shear +	Sliding +	Panel rotation +	Rigid body rotation
				



FEMA



Building Seismic
Safety Council



6.7 CLT Shear Wall Deflection

Table 6-9: CLT Shear Wall Deflection Components and Total Shear Wall Deflection, δ_{SW}

Story	$\frac{576vb_s h^3}{EI_{eff(in-plane)}}$	$\frac{vh}{GA_{eff(in-plane)}}$	$3\Delta_{nail\ slip,h} + 2\Delta_{nail\ slip,v} \left(\frac{h}{b_s}\right)$	$\Delta_a \frac{h}{\sum b_s}$	δ_{SW} , shear wall deflection
	(in.)	(in.)	(in.)	(in.)	(in.)
3	0.02	0.04	0.15	0.04	0.24
2	0.04	0.09	0.16	0.04	0.33
1	0.05	0.11	0.16	0.03	0.35

- For allowable story drift limit is $2.5\%h$ from ASCE/SEI 7-22 Table 12.12-1, corresponding allowable deflection calculated using, C_d , equal to 3 for cross-laminated timber shear walls:

$$\delta_e = \frac{0.025(h)}{C_d} = \frac{0.025(114 \text{ in.})}{3.0} = 0.95 \text{ in.} > \delta_{SW}$$



FEMA



Building Seismic Safety Council



6.8 References

- See the “Useful Design Aid Resources” in Section 6.1 for additional references.
- AWC (2014). *National Design Specification for Wood Construction*, 2015 Edition, NDS-15, American Wood Council.
- van de Lindt, J., Rammer, D., Amini, M. O., Line, P., Pei, S., and Popovski, M. (2021) “Determination of Seismic Performance Factors for Cross-Laminated Timber Shear Walls Based on the FEMA P695 Methodology.” General Technical Report FPL-GTR-281, Madison, WI: U.S. Department of Agriculture, Forest Service, Forest Products Laboratory, (In press).
- FPIinnovations (2013). *US CLT Handbook*, Special Publication SP-529E. Pointe-Claire, QC, Canada.



FEMA



Building Seismic
Safety Council



Questions



FEMA



Building Seismic
Safety Council



DISCLAIMER

- NOTICE: Any opinions, findings, conclusions, or recommendations expressed in this publication do not necessarily reflect the views of the Federal Emergency Management Agency. Additionally, neither FEMA, nor any of its employees make any warranty, expressed or implied, nor assume any legal liability or responsibility for the accuracy, completeness, or usefulness of any information, product or process included in this publication.
- The opinions expressed herein regarding the requirements of the *NEHRP Recommended Seismic Provisions*, the referenced standards, and the building codes are not to be used for design purposes. Rather the user should consult the jurisdiction's building official who has the authority to render interpretation of the code.
- This training material presentation is intended to remain complete in its entirety even if used by other presenters. While the training material could be tailored for use in other presentations, we caution users to account for issues of completeness and interpretation if only part of the material is used. We also strongly suggest users give proper credit/citation to this presentation and its authors.



FEMA



Building Seismic
Safety Council



Chapter 7

Horizontal Diaphragm Design

2020 NEHRP Provisions Training Materials

Kelly Cobeen S.E., *Wiss Janney Elstner Associates*



FEMA



Building Seismic
Safety Council

| BSSC



Welcome to 2020 *NEHRP Provisions* training, Chapter 7 addressing Horizontal diaphragm design. This training is presented in two parts.

Part 1 provides an introduction and presents an example problem with a multi-story steel building with steel deck diaphragms. Part 1 is anticipated to take approximately 90 minutes to present including question and answer sessions.

Part 2 presents an example problem with a single-story large-box building with tilt-up walls and a flexible diaphragm. Part 2 is anticipated to take approximately 60 minutes to present, including a question-and-answer session.

Both examples incorporate the 2020 NEHRP Provisions as incorporated into ASCE/SEI 7-22.

What's New in Diaphragm Design Provisions

- ASCE/SEI 7-10
 - Sections 12.10.1 and 12.10.2 - *Traditional Diaphragm Design Method*
- ASCE/SEI 7-16 (2015 NEHRP Provisions)
 - Section 12.10.3 - *Alternative Design Provisions* is added
 - Cast-in-place concrete, precast concrete, and wood structural panel diaphragms
- ASCE/SEI 7-22 (2020 NEHRP Provisions)
 - Section 12.10.3 - *Alternative Design Provisions* is expanded
 - Bare steel deck, concrete-filled steel deck diaphragms
 - Section 12.10.4 - *Alternative RWFD Provisions* is added



FEMA

Building Seismic
Safety Council



This training on seismic design of horizontal diaphragms is important because there have been significant changes to diaphragm design provisions between ASCE 7-10 and ASCE 7-16 and again between ASCE 7-16 and ASCE 7-22.

Very significant changes include the addition and expansion of diaphragm design methods as follows:

ASCE 7-16 included the addition of the diaphragm alternative design provisions.

ASCE 7-22 included the expansion of the diaphragm alternative design provisions to address bare steel deck diaphragms and concrete-filled steel deck diaphragms.

ASCE 7-22 also included the addition of a diaphragm design method for one-story rigid wall flexible diaphragm structures.

What's New in Diaphragm Design Provisions

- ASCE/SEI 7-16 (2015 NEHRP Provisions)
 - Definition of diaphragm transfer forces
 - Amplification of transfer forces by Ω_0 for horizontal structural irregularity type 4
- ASCE/SEI 7-22 (2020 NEHRP Provisions)
 - Introduction of special seismic detailing provisions for bare steel deck diaphragms
 - Differentiation of design provisions for diaphragms meeting or not meeting the special seismic detailing provisions

From a more detailed perspective,

ASCE 7-16 added the definition for diaphragm transfer forces and designated some circumstances in which transfer forces are to be amplified by a Ω_0 factor.

ASCE 7-22, in concert with AISI S400 have added special seismic detailing provisions for bare steel deck diaphragms.

Why Are Diaphragm Design Provisions Changing?

- Driven by research including both testing and numerical studies
- To better reflect diaphragm dynamic response
- To better reflect diaphragm deformation capacity
- Thought to provide better diaphragm performance at the same or potentially lower cost
- More detail later...

It is reasonable to ask why diaphragm design provisions have been significantly changed. The reasons include the following:

Diaphragm Design Presentation Outline – Part 1

- What's new in 2020 *NEHRP Provisions* and ASCE/SEI 7-22
- Overview of horizontal diaphragm design
- Diaphragm seismic design methods
- Example multi-story steel building with steel deck diaphragms
 - Section 12.10.1 and 12.10.2 ***Traditional Design Method***
 - Section 12.10.3 ***Alternative Design Method***
 - *Comparison of results*



FEMA

Building Seismic
Safety Council



Part 1 of this presentation will cover the following...

Diaphragm Design Presentation Outline – Part 2

- Example one-story RWFD building with steel deck diaphragm
 - Section 12.10.1 and 12.10.2 *Traditional Design Method*
 - Section 12.10.4 *Alternative RWFD Design Method*
 - Comparison of results

Part 2 of this presentation will cover the following...

Overview of Diaphragm Design



FEMA



Building Seismic
Safety Council



We will start with a high-level reminder of the process of diaphragm design.

Overview of Diaphragm Design

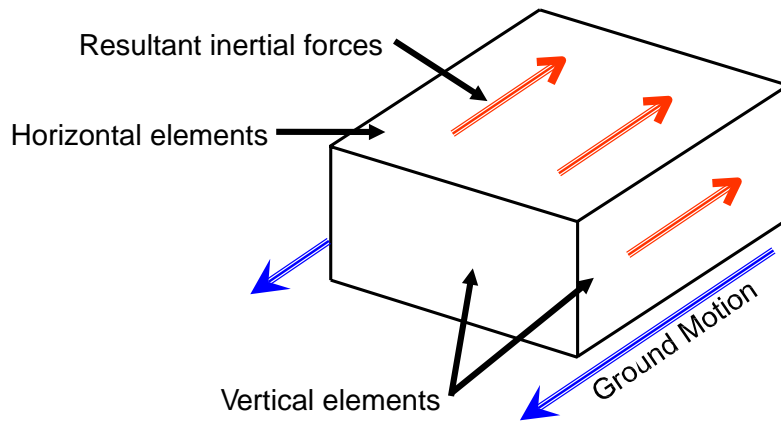
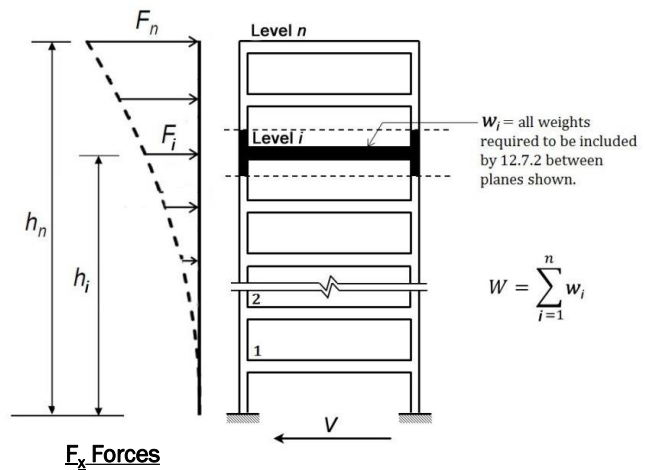

Figure Credit: FEMA, FEMA P-1052 (2016)

This diagram illustrates a simple box building subject to seismic ground motion. Inertial forces are generated by the weight of the structure. The horizontal diaphragm acts like a beam to transmit the horizontal inertial forces generated by its weight to the top of the walls or other vertical elements of the SFRS.

Overview of Diaphragm Design

1. Determine base shear, V , and vertical distribution of F_x forces
2. Categorize diaphragm for purposes of design: Idealized as flexible, Idealized as rigid. Calculated as flexible, Modeled as semi-rigid (or semi-flexible)
3. Apply F_x forces to model and evaluate inherent and accidental torsion (rigid and semi-rigid diaphragms) and transfer forces (all diaphragms)



At a high level, the design of diaphragms starts with the following”

1. Determining the base shear, V , and distributing the base shear vertically to determine F_x forces at each level.
2. Categorizing the diaphragm for purposes of seismic force distribution
3. Apply....

Overview of Diaphragm Design

4. Determine diaphragm F_{px} forces at each story and adjust shear, chord and collector forces from F_x force to F_{px} force level

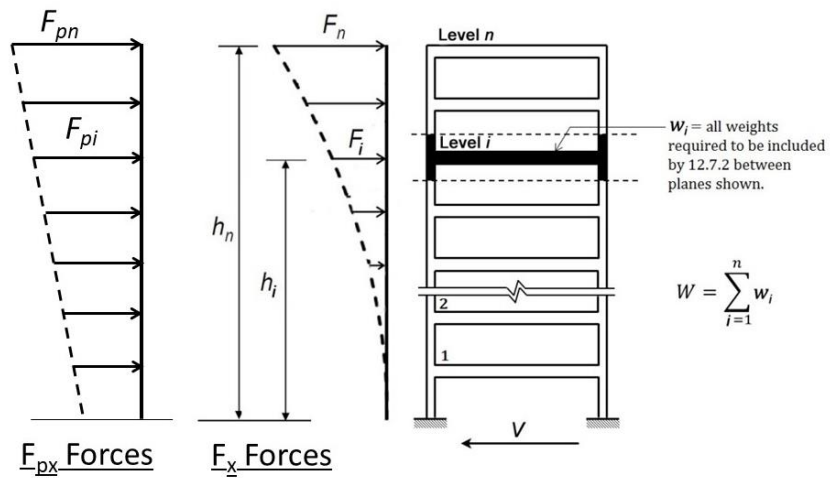

Following the vertical distribution of F_x forces used to design the vertical elements of the SFRS, a second vertical distribution is used to determine the F_{px} forces used for design of diaphragms.

Overview of Diaphragm Design

5. Design diaphragm for shear and flexure
 - Adjust diaphragm transfer forces to overstrength level (at horizontal structural irregularity Type 4 only)
6. Design diaphragm chords, collectors, collector connections to vertical elements
 - Adjust collector forces to overstrength level where applicable
7. Check deflection or drift provisions as applicable

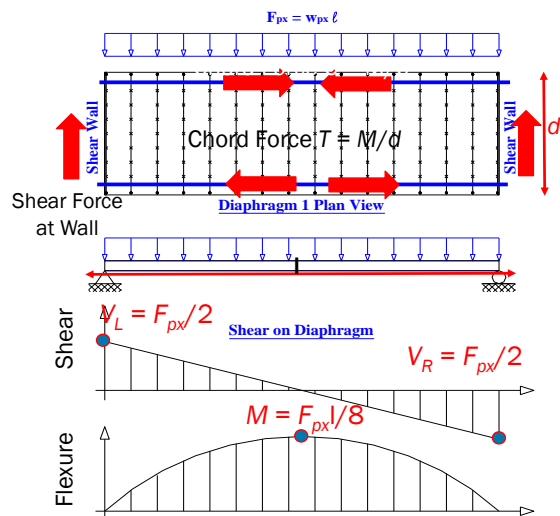

Figure Credit: FEMA, FEMA P-1052 (2016) 11

Once the F_{px} forces are determined, these are used to:

5. Design the diaphragm for shear and flexure, and
6. Design the chords, collectors and collector connections to vertical elements,

Finally applicable deflection or drift provisions need to be checked. These generally look at the story drift or deflection of the full structure, including both vertical and horizontal elements.

The figure on the right illustrates the determination of shear, flexure and chord forces for a flexible diaphragm modeled as a simple-span beam. Where diaphragms are not idealized as flexible, shear flexure and other seismic demand information is extracted from the analysis model.

Overview of Diaphragm Design – Transfer Forces

ASCE/SEI 7-22 Section 11.2:

- **Transfer Forces, Diaphragm:**
Forces that occur in a diaphragm caused by transfer of seismic forces from the vertical seismic force-resisting elements above the diaphragm to other vertical seismic force-resisting elements below the diaphragm because of offsets in the placement of the vertical elements or changes in the relative stiffness of the vertical elements.

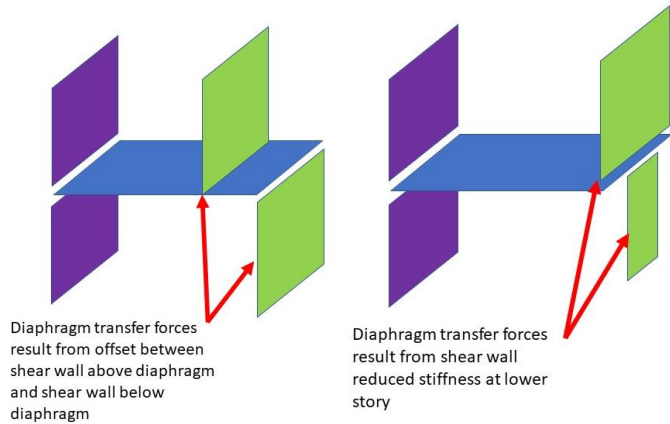

FEMA

Building Seismic Safety Council



12

In one of the introductory slides, it was noted that provisions regarding diaphragm transfer forces were added in ASCE 7-16. On the left the ASCE 7 definition of transfer forces is shown. On the right are two common ways in which diaphragm transfer forces are generated.

-The left figure shows a horizontal offset between shear walls in the first and second stories. The transfer forces occur because forces at the base of the second-story wall need to move through the floor diaphragm to get to first-story shear walls; these forces are diaphragm transfer forces.

-The right figure shows a shear wall of significantly reduced width at the lowest floor. With a rigid or semi-rigid diaphragm assumption, forces from the second floor above will be distributed between the first-story shear walls. Transfer forces are created by the seismic forces that travel through the diaphragm to the left hand first-story wall.

Overview of Diaphragm Design - NEHRP Diaphragm Tech Briefs



NIST, NEHRP Seismic Design Technical Brief No. 3, Seismic Design of Cast-in-Place Concrete Diaphragms, Chords and Collectors (2016)



NIST, NEHRP Seismic Design Technical Brief No. 5, Seismic Design of Composite Steel Deck and Concrete-filled Diaphragms (2011)



NIST, NEHRP Seismic Design Technical Brief No. 10, Seismic Design of Wood Light-Frame Structural Diaphragms (2014)



FEMA

Building Seismic
Safety Council



The construction of diaphragms and their design for shear, flexure, chords and collectors can vary substantially between diaphragm systems, as seen in the NEHRP Tech Brief photos above. These detailed aspects of design will not be addressed in this training, but the derivation of the seismic forces used for design will be, along with detailing provisions for some diaphragm systems.

Overview of Diaphragm Design - NEHRP Diaphragm Tech Briefs

- NIST, 2011. *NEHRP Seismic Design Technical Brief No. 5, Seismic Design of Composite Steel Deck and Concrete-filled Diaphragms* (NIST GRC 11-917-10), National Institute of Standards and Technology, Gaithersburg, MD.
- NIST, 2014. *NEHRP Seismic Design Technical Brief No. 10, Seismic Design of Wood Light-Frame Structural Diaphragm Systems* (NIST GRC 14-917-32), National Institute of Standards and Technology, Gaithersburg, MD.
- NIST, 2016a. *NEHRP Seismic Design Technical Brief No. 12, Seismic Design of Cold-Formed Steel Lateral Load-Resisting Systems* (NIST GRC 16-917-38), National Institute of Standards and Technology, Gaithersburg, MD.
- NIST, 2016b. *NEHRP Seismic Design Technical Brief No. 3, Seismic Design of Cast-in-Place Concrete Diaphragms, Chords and Collectors, Second Edition* (NIST GRC 16-917-42), National Institute of Standards and Technology, Gaithersburg, MD.
- NIST, 2017. *NEHRP Seismic Design Technical Brief No. 12, Seismic Design of Precast Concrete Diaphragms* (NIST GRC 17-917-47), National Institute of Standards and Technology, Gaithersburg, MD.



FEMA



Building Seismic
Safety Council



The above NEHRP Tech Notes are recommended for viewers interested in the details of diaphragm design on a system-by-system basis. While these do not incorporate all of the changes from ASCE 7-16 and 7-22, they provide valuable information on the details of diaphragm design.

Diaphragm Seismic Design Methods

ASCE/SEI 7-22



FEMA

 Building Seismic
Safety Council



Diaphragm Seismic Design Methods

1. Section 12.10.1 and 12.10.2 *Traditional Design Method*
 2. Section 12.10.3 *Alternative Design Method*
 3. Section 12.10.4 *Alternative “RWFD” Design Method:*
 - *Alternative Diaphragm Design Provisions for One-Story Structures with Flexible Diaphragms and Rigid Vertical Elements*
- **Scope: Diaphragms, Chords and Collectors**
 - Design forces
 - In some instances, detailing



As mentioned in the introduction, as of ASCE 7-22, there are now three methods by which seismic design of diaphragms can be provided. These three methods are

It is important to note that the Section 12.10.1 and 12.10.2 traditional diaphragm design provisions still remain and are still permitted with the exception of precast concrete diaphragms in SDC C through F. The two added methods will give the design a choice of methods.

Diaphragm Seismic Design Methods

Method and ASCE/SEI 7 22 Section	Number of Stories Permitted	Diaphragm Systems Included	Comments
Traditional Sections 12.10.1 and 12.10.2	Any	All	<ul style="list-style-type: none"> Not permitted for precast concrete diaphragms in SDC C through F Diaphragm design forces are determined using seismic design parameters (R, Ω_0, and C_d) for the vertical SFRS



FEMA

Building Seismic Safety Council



The above is excerpted from a table in Chapter 7 of the example problems publication and gives a overview of each of the three diaphragm design methods, with the intent of helping the designer decide which method to use.

The first row addresses the Sections 112.10.1 and 12.10.2 Traditional Provisions as follows:

.....

Diaphragm Seismic Design Methods

Method and ASCE/SEI 7 22 Section	Number of Stories Permitted	Diaphragm Systems Included	Comments
Alternative Section 12.10.3	Any	<ul style="list-style-type: none"> ▪ Cast-in-place concrete ▪ Precast concrete ▪ Wood structural panel ▪ Bare steel deck ▪ Concrete-filled metal deck 	<ul style="list-style-type: none"> ▪ Required for precast concrete diaphragms in SDC C through F, providing improved seismic performance ▪ Optional for other diaphragm types ▪ Better reflects vertical distribution of diaphragm forces ▪ R_s diaphragm design force reduction factor better reflects effect of diaphragm ductility and displacement capacity on diaphragm seismic forces ▪ Forces in collectors and their connections to vertical elements are amplified by 1.5 in place of Ω_0



FEMA



Building Seismic Safety Council



The second row addresses the Section 12.10.3 Alternative Provisions as follows:

.....

Diaphragm Seismic Design Methods

Method and ASCE/SEI 7 22 Section	Number of Stories Permitted	Diaphragm Systems Included	Comments
Alternative RWFD Section 12.10.4	One Story	<ul style="list-style-type: none"> ▪ Wood structural panel ▪ Bare steel deck ▪ Diaphragm must meet scoping limitations of ASCE/SEI 7-22 Section 12.10.4.1 	<ul style="list-style-type: none"> ▪ Primarily intended for buildings with diaphragm spans of 100 feet or greater ▪ New T_{diaph}, R_{diaph}, $\Omega_{0-diaph}$, and $C_{d-diaph}$, better reflect response of RWFD building type ▪ Provides better performance with the same or reduced construction cost



FEMA

Building Seismic Safety Council



The third row addresses the Section 12.10.4 Alternative RWFD Provisions as follows:

.....

Diaphragm Seismic Design Methods

- Advantages of using Section 12.10.3 Alternative Design Provisions:
 - Better reflects vertical distribution of diaphragm forces
 - Better reflects effect of diaphragm ductility and displacement capacity
 - May result in lower seismic demands
- Advantages of using Section 12.10.4 Alternative RWFD Method;
 - Better reflects seismic response of RWFD buildings
 - May result in lower seismic demands
 - Is anticipated to result in better performance
- When will the Section 12.10.1 and 12.10.2 Traditional Method result in lower design forces?
 - Bare steel deck diaphragms not meeting the AISI S400 special seismic detailing provisions
 - Other



FEMA



Building Seismic
Safety Council



It is worthwhile to consider some of the advantages of design in accordance with the newer diaphragm design provisions

Introduction to Section 12.10.3 Alternative Design Provisions

Part 1: Vertical distribution of seismic forces for near-elastic diaphragm behavior

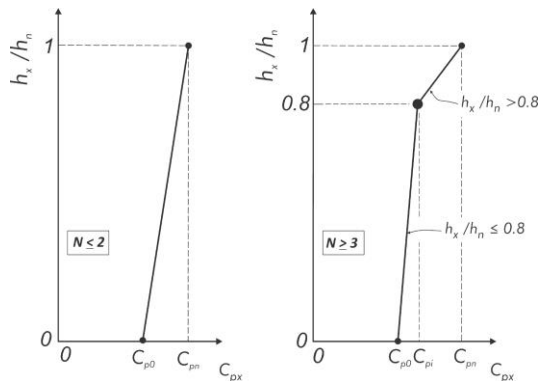

Part 2: Parameter R_s modifies near-elastic forces based on diaphragm ductility and deformation capacity

$$F_{px} = \frac{C_{px}}{R_s} W_{px}$$



21

The next few slides will provide a brief introduction to the Section 12.10.3 Alternative Design Provisions.

There are two primary parts to the changes incorporated into the Alternative Design Provisions:

- The first part, seen on the left, involved derivation and vertical distribution of diaphragm seismic forces based on an assumption of near-elastic diaphragm response. This was driven by a collection of a significant body of diaphragm force information from testing and numerical studies.
- The second part, seen on the right, involved the derivation of R_s diaphragm design force reduction factors, serving to reduce the near-elastic diaphragm forces based on ductility and deformation capacity of the diaphragm system. These also were derived from testing and numerical studies.

Introduction to Section 12.10.3 Alternative Design Provisions

Studies Behind Alternative Provisions Diaphragm Forces and Tabulated R_s factors:

- Precast concrete diaphragms
 - Fleischman R.B., Restrepo J.I., Naito C.J., Sause R., Zhang D. and Schoettler M., 2013. "Integrated Analytical and Experimental Research to Develop a New Seismic Design Methodology for Precast Concrete Diaphragms," *ASCE J. Struct. Engr.*, 139(7), 1192-1204.
 - 2020 *NEHRP Provisions* Commentary
- Concrete diaphragms - 2020 *NEHRP Provisions* Commentary
- Wood structural panel diaphragms – 2020 *NEHRP Provisions* Commentary

The above notes some of the studies behind these changes in the diaphragm design provisions.

Introduction to Section 12.10.3 Alternative Design Provisions

Studies Behind Tabulated R_s factors:

- Bare steel deck diaphragms and concrete filled metal deck diaphragms
 - O'Brien, P., Eatherton, M.R., and Easterling, W.S., 2017. "Characterizing the Load-Deformation Behavior of Steel Deck Diaphragms using Past Test Data," Cold-Formed Steel Research Consortium Report Series, CFSRC R-2017-02
 - Schafer, 2019. *Research on the Seismic Performance of Rigid Wall Flexible Diaphragm Buildings with Bare Steel Deck Diaphragms*, CFSRC Report 2019-2.
 - Wei, G., Foroughi, H., Torabian, S., Schafer, B.W., and Eatherton, M.R., 2019. "Evaluating Different Diaphragm Design Procedures Using Nonlinear 3D Computational Models," 12th Canadian Conference on Earthquake Engineering, Quebec QC, June 17-20
 - Avellaneda, R.E., Easterling, W.S., Schafer, B.W., Hajjar, J.F., and Eatherton, M.R., 2019. "Cyclic Testing of Composite Concrete on Metal Deck Diaphragms Undergoing Diagonal Tension Cracking," 12th Canadian Conference on Earthquake Engineering, Quebec QC, June 17-20.
 - Foroughi, H., Wei, G., Torabian, S., Eatherton, M.R., and Schafer, B.W., 2019. "Seismic Demands on Steel Diaphragms for 3D Archetype Buildings with Concentric Braced Frames," 12th Canadian Conference on Earthquake Engineering, Quebec QC, June 17-20



The above notes more of the studies behind these changes in the diaphragm design provisions.

Introduction to Section 12.10.3 Alternative Design Provisions – Part 1

3-Story PCI Building – test results

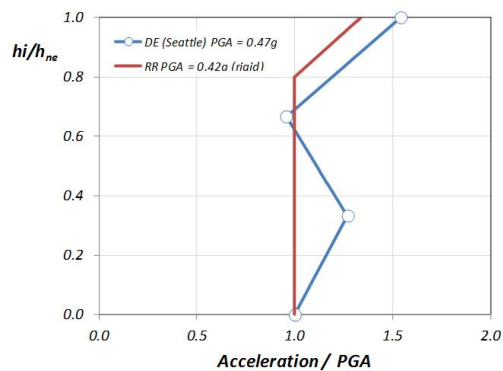

Figure Credit: FEMA, FEMA P-1052 (2016)
Courtesy of Jose Restrepo, UC San Diego



Steel BRB and special MRF buildings - analysis

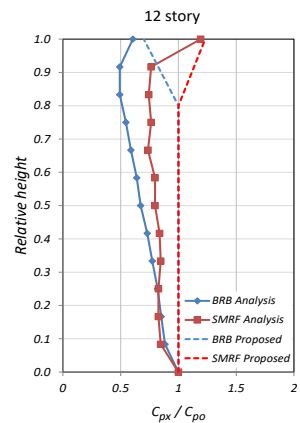

Figure Credit: FEMA, FEMA P-1052, (2016) Courtesy of Jose Restrepo, UC San Diego

24

This slide shows some of the data that was considered in the derivation of the alternative seismic design forces and their vertical distribution. See the commentary to the 2020 NEHRP Provisions for a detailed discussion.

Introduction to Section 12.10.3 Alternative Design Provisions – Part 2

Diaphragm System		R_s Shear Controlled ^a	R_s Flexure Controlled ^a
Cast-in-place concrete designed in accordance with ACI 318	-	1.5	2
Precast concrete designed in accordance with ACI 318	Elastic design option	0.7	0.7
	Basic design option	1.0	1.0
	Reduced design option	1.4	1.4
Wood sheathed designed in accordance with ASCE/SEI 7-22 Section 14.5 and AWC <i>Special Design Provisions for Wind and Seismic</i>	-	3.0	NA
Bare steel deck designed in accordance with ASCE/SEI 7-22 Section 14.1.5	With special seismic detailing	2.5	NA
	Other	1.0	NA
Concrete-filled metal deck designed in accordance with ASCE/SEI 7-22 Section 14.1.6	-	2.0	NA



FEMA

Building Seismic Safety Council



The above table shows the diaphragm seismic force reduction factors, R_s , as incorporated into ASCE 7-22. The top three diaphragm systems were included in ASCE 7-16. The bottom two diaphragm systems were added in ASCE 7-22, addressing base steel deck diaphragms and concrete-filled steel deck diaphragms.

Introduction to Section 12.10.4 Alternative RWFD Design Method

Acknowledge and incorporate actual seismic response of RWFD buildings for diaphragm design

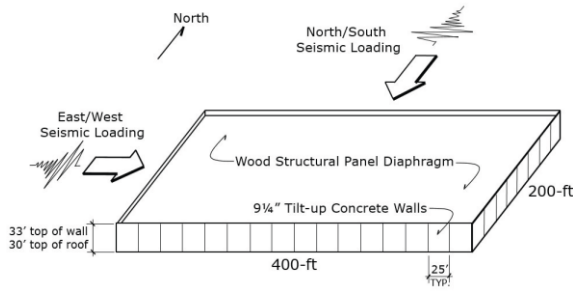
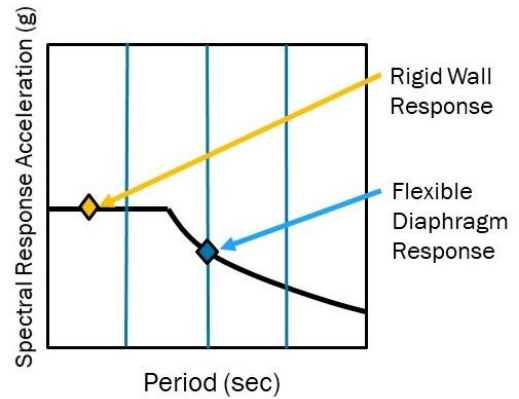

Figure Credit: FEMA, FEMA P-1026 (2014)



FEMA



Building Seismic Safety Council



The next few slides will provide a brief introduction to the Section 12.10.4 Alternative RWFD Design Provisions.

It has long been recognized that large footprint buildings with rigid vertical elements and flexible diaphragms have seismic response driven primarily by the flexible vertical diaphragm rather than the rigid vertical elements.

The traditional diaphragm design method ignores this behavior, calculating the diaphragm seismic forces as a function of the system used for the vertical elements.

The Alternative RWFD design method incorporates this known behavior into diaphragm design.

Introduction to Section 12.10.4 Alternative RWFD Design Method

Studies Behind Alternative RWFD Design Method:

- FEMA, 2021. *Seismic Design of Rigid Wall-Flexible Diaphragm Buildings: An Alternate Procedure* (FEMA P-1026), Federal Emergency Management Agency, Washington, DC
- Koliou, M., Filiatrault, A., Kelly, D., and Lawson, J., 2015a. "Buildings with Rigid Walls and Flexible Diaphragms I: Evaluation of Current U.S. Seismic Provisions," *Journal of Structural Engineering*, American Society of Civil Engineers, Reston, VA.
- Koliou, M., Filiatrault, A., Kelly, D., and Lawson, J., 2015b. "Buildings with Rigid Walls and Flexible Diaphragms II: Evaluation of a New Seismic Design Approach Based on Distributed Diaphragm Yielding," *Journal of Structural Engineering*, American Society of Civil Engineers, Reston, VA.
- Schafer, 2019. *Research on the Seismic Performance of Rigid Wall Flexible Diaphragm Buildings with Bare Steel Deck Diaphragms*, CFSRC Report 2019-2.



FEMA

 Building Seismic
Safety Council



As was true in the Section 12.10.3 Alternative Design Provisions, the Section 12.101.4 Alternative RWFD Design Provisions also have significant research serving as the basis, as seen in the references shown above.

Introduction to Section 12.10.4 Alternative RWFD Design Method

Design to encourage distributed inelastic behavior for improved seismic performance

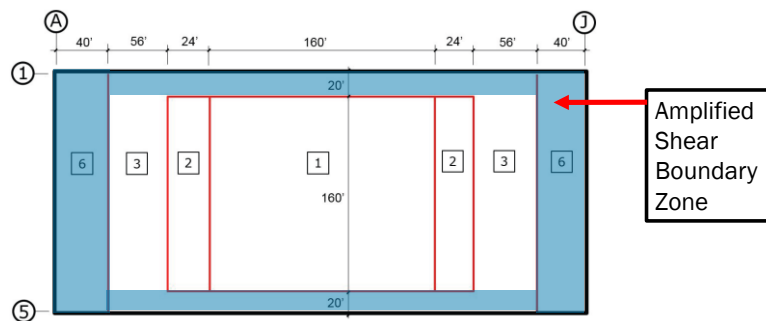

Figure Based on FEMA, FEMA P-1026 (2014)



FEMA



Building Seismic
Safety Council



In addition to developing more realistic seismic design forces, the Alternative RWFD provisions incorporate a method of achieving better seismic performance. This is accomplished by designing a boundary zone for amplified shears. This reinforces the diaphragm zones alongside the vertical elements that see the highest forces and would otherwise experience very high inelastic demands. As a result of this, numerical studies have demonstrated that inelastic behavior will be better distributed through the interior portions of the diaphragm.

Introduction to Section 12.10.4 Alternative RWFD Design Method

Optional incorporation of actual seismic response of RWFD buildings for vertical elements – 2 stage analysis

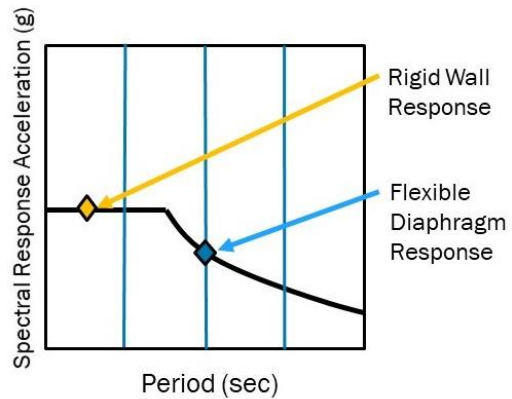
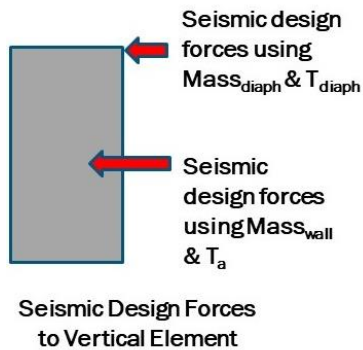

FEMA



Building Seismic
Safety Council



A second, optional portion of the Alternative RWFD provisions allow the designer to use a two-stage analysis method for the vertical elements of the seismic force resisting system. This method sums for design of the wall the forces from the diaphragm based on flexible diaphragm response with the forces from mass tributary to the wall considering rigid wall response, as shown in the diagram above.

Example Multi-Story Steel Building with Steel Deck Diaphragms



FEMA



Building Seismic
Safety Council



30

Next, we will go through a design example using a multi-story steel building with steel deck diaphragms. The slides will follow in detail the design example found in Section 7.5 of the 2020 NEHRP example problems publication. The diaphragm seismic design forces will first be calculated using the Section 12.10.1 and 12.10.2 Traditional Method. The diaphragm seismic design forces will then be calculated using the Section 12.10.3 Alternative Method.

This example focuses on an ELF seismic design. Some variations would occur in a modal response spectrum design were to be used.

Example Multi-Story Steel Building with Steel Deck Diaphragms

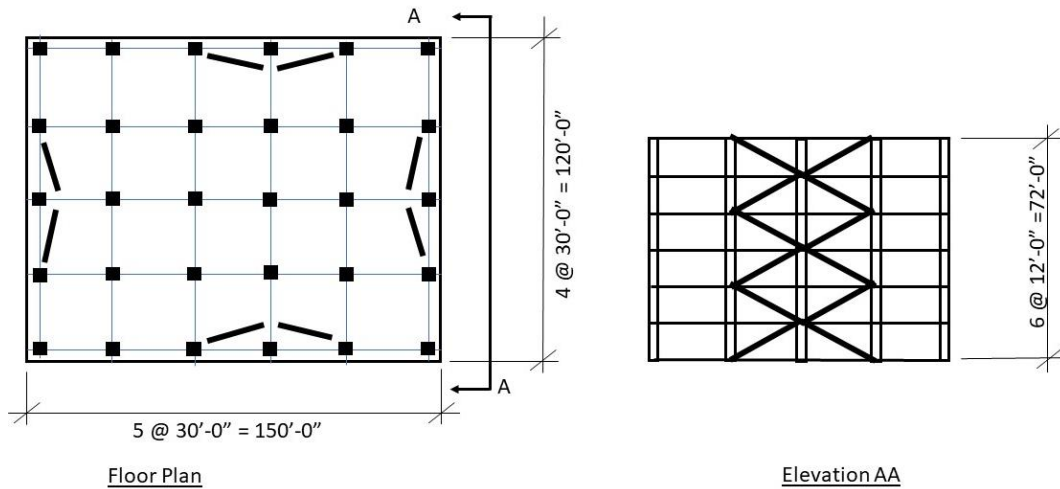

This slide shows the plan and an elevation of the six-story building that we will use. The plan shows columns and shows steel concentric braced frames on all four exterior walls. Elevation AA shows the elevation of the right-hand side exterior framing bay. Included are super-X braced frames in the center two framing bays.

Example Multi-Story Steel Building with Steel Deck Diaphragms

Building Configuration

- Six stories
- Risk Category II, $I_e = 1.0$
- Mean roof height = 72 feet - six stories at 12 feet each
- Length = 150 feet
- Width = 120 feet
- $S_{DS} = 1.2$, $S_{D1} = 0.70$ (determined using ASCE/SEI 7-22 Section 11.4.4)
- Floor Diaphragm: Concrete-filled metal deck
- Roof Diaphragm: Bare steel deck
- Steel special concentrically braced frame system - $R = 6$, $\Omega_0 = 2$
- ρ , $\rho = 1.0$ for both vertical elements and diaphragm
- All seismic forces are at strength level

This slide identifies some of the configuration and seismic design parameters for this buildings

Example Multi-Story Steel Building with Steel Deck Diaphragms

Building Analytical Modeling

- The step-by-step descriptions in this presentation focus on use of the ASCE/SEI 7-22 equivalent lateral force (ELF) procedure; some modifications are needed when using linear dynamic analysis procedures.
- This step-by-step description also focuses primarily on diaphragm inertial forces due to the mass tributary to each diaphragm level. Where diaphragm transfer forces as defined in ASCE/SEI Section 11.2 occur, they are required to be addressed in accordance with ASCE/SEI 7-22 Section 12.10.1.1 or 12.10.3.3, as applicable.



FEMA



Building Seismic
Safety Council



Before discussing details of diaphragm design forces, some discussion of analytical modeling is appropriate.

Example Multi-Story Steel Building with Steel Deck Diaphragms

Building Analytical Modeling (continued)

- In order to perform seismic analysis of the SFERS and diaphragms, it is necessary to define the diaphragm flexibility in accordance with ASCE/SEI 7-22 Section 12.3. This section sets criteria by which diaphragms can be idealized as flexible, idealized as rigid, or calculated as flexible. Where these do not apply, the diaphragm is required to be modeled as semi-rigid.
- Where diaphragms are designated as rigid or semi-rigid for modeling and design, the process of seismic design will start with overall modeling of the building and then proceed to diaphragm design. Regardless of diaphragm designation, the seismic design of the diaphragm and vertical elements usually proceed in parallel.

Further comments on analytical modeling include...

Example Multi-Story Steel Building with Steel Deck Diaphragms

Step 1 - Weight for Seismic Analysis

- Roof + ceiling = 40 psf
- Floor + ceiling = 80 psf
- Exterior wall = 20 psf
- Interior partitions are included as 10 psf in floor + ceiling weight of 80 psf



FEMA

Building Seismic
Safety Council



The unit weights for roof, ceiling and wall are provided as...

Note that seismic mass from interior partitions is included in the floor plus ceiling weights shown, as required by ASCE/SEI 7-22

Example Multi-Story Steel Building with Steel Deck Diaphragms

Step 1 - Seismic weight at roof

Roof: $40 \text{ psf} (150 \text{ ft})(120 \text{ ft}) = 720 \text{ kips}$

Longitudinal exterior walls: $20 \text{ psf} (150 \text{ ft})(12/2 + 4 \text{ ft})(2 \text{ sides}) = 60 \text{ kips}$

Transverse exterior walls: $20 \text{ psf} (120 \text{ ft})(12/2 + 4 \text{ ft})(2 \text{ sides}) = 48 \text{ kips}$

TOTAL = $720 + 60 + 48$
= 828 kips acting at roof



The total mass acting at the roof is summed to be....

Resulting in a total seismic mass of 828 kips acting at the roof.

Example Multi-Story Steel Building with Steel Deck Diaphragms

Step1 - Seismic weight at 2nd through 6th floors

Floor: $80 \text{ psf} (150 \text{ ft})(120 \text{ ft}) = 1440 \text{ kips}$

Longitudinal exterior wall: $20 \text{ psf} (150 \text{ ft})(12 \text{ ft})(2 \text{ sides}) = 72 \text{ kips}$

Transverse exterior wall: $20 \text{ psf} (120 \text{ ft})(12 \text{ ft})(2 \text{ sides}) = 58 \text{ kips}$

TOTAL = $1440 + 72 + 58$

= $1,570 \text{ kips}$ acting at each floor

Seismic weight TOTAL = $828 + 5 (1,570) = 8,678 \text{ kips}$



FEMA



Building Seismic
Safety Council



The seismic weight acting at each floor level is summed to be

Resulting in a seismic mass of 1570 kips acting at each floor.

With this information the full seismic weight for the building is calculated to be 8678 kips.

Example Multi-Story Steel Building with Steel Deck Diaphragms

Step 1 - Diaphragm seismic weight, w_{px} , at the roof:

= 828 kips (transverse and longitudinal directions)

Step 1- Diaphragm seismic weight, w_{px} , at the 2nd through 6th floors:

= 1,570 kips (transverse and longitudinal direction)

Diaphragm seismic weights with exterior wall weight parallel to the direction of seismic forces neglected are between 4 and 8 percent lower than total seismic weight. These forces are not carried by the diaphragm but instead act directly at the vertical elements. For simplicity, however, use total seismic weights of 828 and 1,570 kips to determine diaphragm design forces.

From Step 1 we have w_{px} seismic weight acting at the roof and typical floor of 828 and 1570 kips, respectively.

In some instances, the designer may want to subtract the weights of the exterior wall from the w_{px} forces. This can be done because this weight is not traveling through the diaphragm to the exterior wall where the braces are located but originates at the exterior wall and therefore does not load the diaphragm. While this is permitted, the weight of the exterior wall may not be large enough to justify the introduction of this level of complexity in the seismic calculations. For this reason, the weight of the exterior walls is included in the w_{px} used for diaphragm design. For this building this will result in diaphragm design forces that are conservative by 4 to 8 percent.

Example Multi-Story Steel Building with Steel Deck Diaphragms

Step 2 - ASCE 7 Base Shear

$$T_a = C_t h_n^x = 0.020(72)^{0.75} = 0.49 \text{ sec} \quad (\text{ASCE/SEI 7-22 Eq. 12.8-7})$$

$$C_s = \frac{S_{DS}}{R} = \frac{1.20}{6} = 0.200 \text{ (governs)} \quad (\text{ASCE/SEI 7-22 Eq. 12.8-2})$$

C_s need not exceed:

$$C_s = \frac{S_{D1}}{T\left(\frac{R}{I_e}\right)} = \frac{0.70}{0.49\left(\frac{6}{1}\right)} = 0.238 \quad (\text{ASCE/SEI 7-22 Eq. 12.8-3})$$

$$V = C_s W = 0.20 (8,678) = 1,736 \text{ kips} \quad (\text{ASCE/SEI 7-22 Eq. 12.8-1})$$

Example Multi-Story Steel Building with Steel Deck Diaphragms

Step 3 - Vertical distribution of seismic base shear:

The lateral seismic force at any level is determined as

$$F_x = C_{vx} V \quad (\text{ASCE/SEI 7-22 Eq. 12.8-11})$$

Where:

$$C_{vx} = \frac{w_x h_x^k}{\sum_{i=1}^n w_i h_i^k} \quad (\text{ASCE/SEI 7-22 Eq. 12.8-12})$$

For $T \leq 0.5$ sec., $k = 1.0$

Example Multi-Story Steel Building with Steel Deck Diaphragms

Table 7.5-1: Vertical Distribution of Base Shear

Level X	w_x (kips)	h_x (ft)	$w_x h_x^k$ (ft kips)	C_{vx}	F_x (kips)
Roof	828	72	59,616	0.174	302
6	1,570	60	94,200	0.275	478
5	1,570	48	75,360	0.220	382
4	1,570	36	56,520	0.165	287
3	1,570	24	37,680	0.110	191
2	1,570	12	18,840	0.055	96
Sum	8,678		342,216	0.999	1,736

1.0 kip = 4.45 kN, 1.0 ft = 0.3048 m, 1.0 ft-kip = 1.36 kN-m



FEMA

Building Seismic
Safety Council



Example Multi-Story Steel Building with Steel Deck Diaphragms

Traditional Design Method (12.10.1 & 12.10.2)



FEMA



Building Seismic
Safety Council



42

From this point on, the diaphragm seismic design provisions will start to diverge between the Section 12.10.1 and 12.10.2 Traditional Design Method and the Section 12.10.3 Alternative Design Method. We will first look at the Traditional Design Method.

Traditional Design Method

Step 4 - Strength level diaphragm design force, F_{px} :

Diaphragm design force is given by the larger of F_x determined previously and F_{px} .

$$F_{px} = \frac{\sum_{i=x}^n F_i}{\sum_{i=x}^n w_i} w_{px} \quad (\text{ASCE/SEI 7-22 Eq. 12.10-1})$$

Note that for purposes of diaphragm forces ρ is set to 1.0.

Designers should be familiar with this equation for the vertical distribution of diaphragm design forces. Note that ρ is set to 1.0 for purposes of calculating diaphragm design forces.

Traditional Design Method

Table 7.5-2: Diaphragm Seismic Forces, F_{px}

Level	w_j (kips)	$\sum_{i=x}^n w_i$ (kips)	F_j (kips)	$\sum_{i=x}^n F_i = V_i$ (kips)	w_{px} (kips)	$F_{px} = \frac{\sum_{i=x}^n F_i}{\sum_{i=x}^n w_i} w_{px}$ (kips)
Roof	828	828	302	302	828	302
6	1,570	2,398	478	780	1,570	510
5	1,570	3,968	382	1,162	1,570	460
4	1,570	5,538	287	1,449	1,570	411
3	1,570	7,108	191	1,640	1,570	362
2	1,570	8,678	96	1,736	1,570	314
Sum	8,678		1,736		8,678	

1.0 kip = 4.45 kN



FEMA



Building Seismic
Safety Council



Using information from the previous steps, this table shows the calculation of F_{px} forces over the height of the structure.

Traditional Design Method

F_{px} at the roof cannot be less than:

$$\begin{aligned} F_{pr} &= 0.2S_{DS}I_eW_{pr} && \text{(ASCE/SEI 7-22 Eq. 12.10-2)} \\ &= 0.2(1.2)(1.0)(828) = 199 \text{ kips} \end{aligned}$$

F_{px} at the floor levels cannot be less than:

$$\begin{aligned} F_{px} &= 0.2S_{DS}I_eW_{px} && \text{(ASCE/SEI 7-22 Eq. 12.10-2)} \\ &= 0.2(1.2)(1.0)(1,570) = 377 \text{ kips} \end{aligned}$$



FEMA

Building Seismic
Safety Council



The lower limits for the F_{px} forces are shown here....

Traditional Design Method

F_{pr} at the roof need not exceed:

$$\begin{aligned} F_{pr} &= 0.4S_{DS}I_eW_{pr} && \text{(ASCE/SEI 7-22 Eq. 12.10-3)} \\ &= 0.4(1.2)(1.0)(828) = 397 \text{ kips} \end{aligned}$$

F_{px} at the floor levels need not exceed:

$$\begin{aligned} F_{px} &= 0.4S_{DS}I_eW_{px} && \text{(ASCE/SEI 7-22 Eq. 12.10-3)} \\ &= 0.4(1.2)(1.0)(1,570) = 754 \text{ kips} \end{aligned}$$

And the upper limits for the F_{px} forces are calculated here...

Traditional Design Method

Table 7.5-3: Summary of Diaphragm Design Forces

Level	F_{px} From Vertical Distribution (kips)	F_{px} Minimum (kips)	F_{px} Maximum (kips)	F_{px} Design (kips)
Roof	302	199	397	302
6	510	377	754	510
5	460	377	754	460
4	411	377	754	411
3	362	377	754	377
2	314	377	754	377

1.0 kip = 4.45 kN



FEMA



Building Seismic
Safety Council



This table summarizes the F_{px} forces calculated using at each story, the lower-limit forces, the upper-limit forces, and the F_{px} forces assigned for diaphragm design (right-hand column).

Traditional Design Method

Step 5 – Diaphragm Transfer Forces

- Diaphragm transfer forces, as defined in ASCE/SEI 7-22 Section 11.2, occur where vertical elements of the SFRS are offset or discontinued at lower levels; they also occur due to changes in the stiffness of the SFRS vertical elements between levels. The occurrence of diaphragm transfer forces is determined by examining the distribution of forces from the analysis model.
- For simplicity, the building in this example building is assumed to not have diaphragm transfer forces.

Step 5 addresses diaphragm transfer forces. This topic was discussed in the introduction portion of this presentation....

Traditional Design Method

Step 6 – Design for Shear and Flexure

- Diaphragms at each level are designed for shear and flexure using the tabulated F_{px} design forces. Should diaphragm transfer forces be applicable these would also be included and be amplified where required.
- Where a computer analysis model is used, this can involve taking the shear and flexure forces at the F_x level from the model and amplifying them to the F_{px} level.
- For diaphragms idealized as rigid or semi-rigid, inherent torsion, accidental torsion and transfer forces are addressed in the building model such that the extracted shear and flexure forces include these effects.

Step 6 addresses the design of diaphragms for shear and flexure based on the derived diaphragm design forces.

Traditional Design Method

Step 7 - Collector Seismic Design Forces

Collectors in the example building are, per ASCE/SEI 7-22 Section 12.10.2.1, required to be designed for seismic loads effect including overstrength. This involves the seismic load effect with overstrength provisions of ASCE/SEI 7-22 Section 12.4.3, used in the appropriate load combinations from ASCE/SEI 7-22 Chapter 2. The following demonstrates the calculation of the collector seismic design force due to horizontal seismic forces. This will need to be combined with applicable gravity loads and vertical seismic forces.

Step 7 addresses collector seismic design forces....

Traditional Design Method

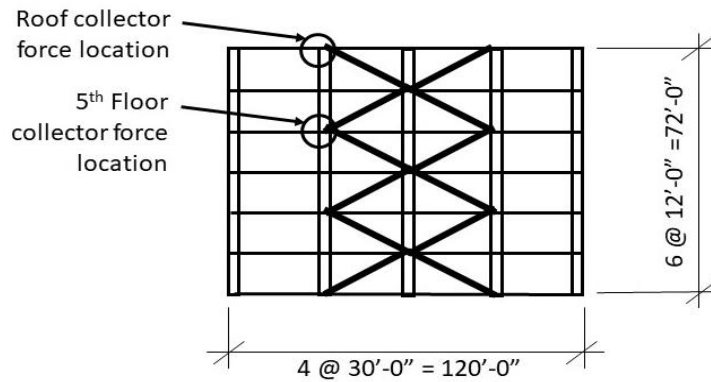

Elevation AA



FEMA

Building Seismic
Safety Council



To illustrate the calculation of collector forces the exterior framing line shown above will be used. We will calculate the collector forces at the 5th floor and roof levels.

Traditional Design Method

Step 7 - Diaphragm Transverse Force Reactions and Units Shears

The roof diaphragm is idealized to be flexible. As a result, the diaphragm reaction to the exterior wall line can be based on tributary seismic weight or a simple-span beam idealization. Based on this assumption:

$$\begin{aligned} \text{Roof Diaphragm} \quad V &= 302 \text{ kips} / 2 = 151 \text{ kips} \\ v &= 151 \text{ kips} / 120 \text{ ft} = 1.26 \text{ klf} \end{aligned}$$



Traditional Design Method

Step 7 - Diaphragm Transverse Force Reactions and Units Shears

For this example, the floor diaphragms are idealized as rigid. As a result, inherent and accidental torsion are applied to the model seismic forces in accordance with Sec. 12.8.4. In this example it is assumed a 10% increase of the floor diaphragm shear due to torsion and any transfer forces. Based on this assumption:

$$\begin{aligned} \text{5th Floor diaphragm } V &= 460 \text{ kips } (1.1) / 2 = 253 \text{ kips} \\ v &= 253 \text{ kips} / 120 \text{ ft} = 2.11 \text{ kif} \end{aligned}$$

Traditional Design Method

Step 7 - Collector Force at Location shown in Figure 7.5-2, amplified by $\Omega_0 = 2.0$

Roof Diaphragm

$$T/C = 1.26 \text{ klf (30 ft) (2.0) = 76 \text{ kips}}$$

5th Floor Diaphragm

$$T/C = 2.11 \text{ klf (30 ft) (2.0) = 127 \text{ kips}}$$

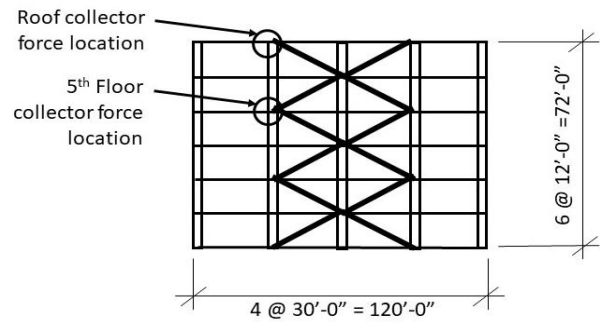

Elevation AA



FEMA

Building Seismic
Safety Council



Traditional Design Method

Step 8 – Deflection and Drift Requirements

For ELF design, this step incorporates the revised displacement and drift determination provisions of ASCE/SEI 7-22 Section 12.8.6 and the drift and deformation provisions of Section 12.12.

The structural separation provisions of Section 12.12.2, structural separation requirements of Section 12.12.3, and deformation compatibility provisions of 12.12.4 each require that diaphragm deflection be considered in addition to the deflection of the vertical elements.

Example Multi-Story Steel Building with Steel Deck Diaphragms

Alternative Design Method (12.10.3)



FEMA



Building Seismic
Safety Council



Steps 4 through 8 will now be repeated using the ASCE/SEI 7-22 Alternative Diaphragm Design Method. This was first added in ASCE 7-22 and expanded to include steel deck diaphragms in ASCE/SEI 7-16.

Alternative Design Provisions (Section 12.10.3) - Introduction

Part 1: Vertical distribution of seismic forces for near-elastic diaphragm behavior

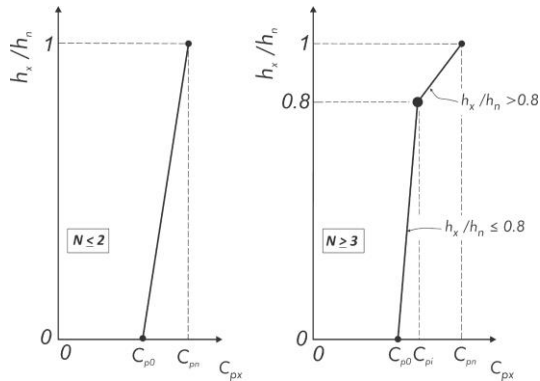

Part 2: Parameter R_s modifies near-elastic forces based on diaphragm ductility and deformation capacity

$$F_{px} = \frac{C_{px}}{R_s} W_{px}$$



FEMA

Building Seismic Safety Council



As a quick reminder, the two major differences incorporated in the Alternative Design Procedure are...

Alternative Design Method (Section 12.10.3) - Introduction

Advantages of using Section 12.10.3 Alternative Design Provisions:

- Better reflects vertical distribution of diaphragm forces
- Better reflects affect of diaphragm ductility and displacement capacity
- May result in lower seismic demands



FEMA



Building Seismic
Safety Council



It is advantageous to use the Alternative Design Procedure because...

Example Multi-Story Steel Building with Steel Deck Diaphragms

Table 7.5-1: Vertical Distribution of Base Shear

Level X	w_x (kips)	h_x (ft)	$w_x h_x^k$ (ft kips)	C_{vx}	F_x (kips)
Roof	828	72	59,616	0.174	302
6	1,570	60	94,200	0.275	478
5	1,570	48	75,360	0.220	382
4	1,570	36	56,520	0.165	287
3	1,570	24	37,680	0.110	191
2	1,570	12	18,840	0.055	96
Sum	8,678		342,216	0.999	1,736

1.0 kip = 4.45 kN, 1.0 ft = 0.3048 m, 1.0 ft-kip = 1.36 kN-m



FEMA



Building Seismic
Safety Council



At the end of Step 3 the vertical distribution of the F_x forces had been calculated, as tabulated above. We will move forward from this point using the Alternative Diaphragm Design Method of Section 12.10.3.

Alternative Design Method (Section 12.10.3)

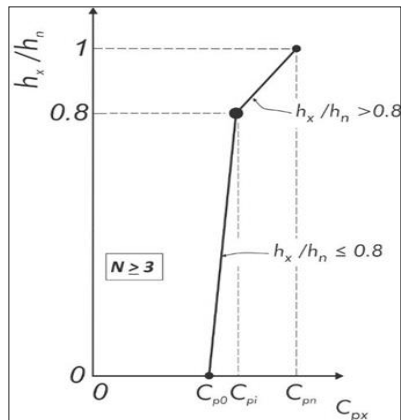

Figure 7.5-3. Calculating the Design Acceleration Coefficient, C_{px} , in Buildings with $N \geq 3$ (ASCE/SEI 7 Figure 12.10-2)



FEMA

Building Seismic
Safety Council



Step 4 addresses vertical distribution of diaphragm F_{px} forces. When using the Alternative Design Procedure for buildings with three or more stories, the figure shown dictates the F_{px} forces at each story level.

Alternative Design Method (Section 12.10.3)

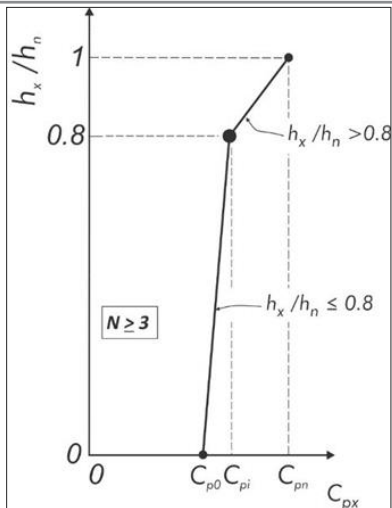

$N = 6$

$z_s = 1.0$ (all other SFRS, ASCE/SEI 7-22 Section 12.10.3.2.1)

$R_s = 2.0$ for concrete-filled metal deck floor diaphragm (ASCE/SEI 7-22 Table 12.10-1)

$R_s = 1.0$ bare steel deck roof diaphragm with welded connections not meeting special seismic detailing provisions (ASCE/SEI 7-22 Table 12.10-1)

$C_s = 0.200$ (Slide 39)



FEMA



Building Seismic Safety Council



61

The background for this pattern of vertical distribution and supporting research was already discussed in the introduction to this presentation.

In order to move forward with calculation of F_{px} forces, a series of variables need to be defined.

$N =$ number of stories = 6

Alternative Design Method (Section 12.10.3)

ASCE/SEI 7-22 Table 12.10-1 Diaphragm Design Force Reduction Factor, R_s

Diaphragm System		Shear Controlled ^a	Flexure Controlled ^a
Cast in place concrete designed in accordance with ACI 318	-	1.5	2
Precast concrete designed in accordance with ACI 318	Elastic design option	0.7	0.7
	Basic design option	1.0	1.0
	Reduced design option	1.4	1.4
Wood sheathed designed in accordance with ASCE/SEI 7 22 Section 14.5 and AWC <i>Special Design Provisions for Wind and Seismic</i>	-	3.0	NA
Bare steel deck designed in accordance with ASCE/SEI 7 22 Section 14.1.5	With special seismic detailing	2.5	NA
	Other	1.0	NA
Concrete filled steel deck designed in accordance with ASCE/SEI 7 22 Section 14.1.6	-	2.0	NA



FEMA



Building Seismic Safety Council



62

R_s factors are found in ASCE/SEI 7-22 Table 12.10-1, as shown above. The R_s factor serves to reduce the diaphragm design forces from a near-elastic level to a force level that reflects the diaphragm ductility and displacement capacity, as determined using testing and analytical studies.

R_s for the concrete-filled steel deck floor diaphragm can

Alternative Design Method (Section 12.10.3)

Modal Contribution Coefficient Modifier, z_s (ASCE/SEI 7-22 Section 12.10.3.2.1)

Description	z_s value
Buildings designed with Buckling Restrained Braced Frame systems defined in ASCE/SEI 7-22 Table 12.2.1	0.30
Buildings designed with Moment Resisting Frame systems defined in ASCE/SEI 7-22 Table 12.2.1	0.70
Buildings designed with Dual Systems defined in ASCE/SEI 7-22 Table 12.2.1 with Special or Intermediate Moment Frames capable of resisting at least 25% of the prescribed seismic forces	0.85
Buildings designed with all other seismic force resisting systems	1.00



FEMA

Building Seismic
Safety Council



63

z_s factors are found in ASCE/SEI 7-22 Section 12.10.3.2.1 and are provided in tabular form above for ease of use. These are again derived from research. A larger value of z_s will result in a larger contribution of higher mode behavior to F_{px} forces.

z_s for this steel braced frame building...

Alternative Design Method (Section 12.10.3)

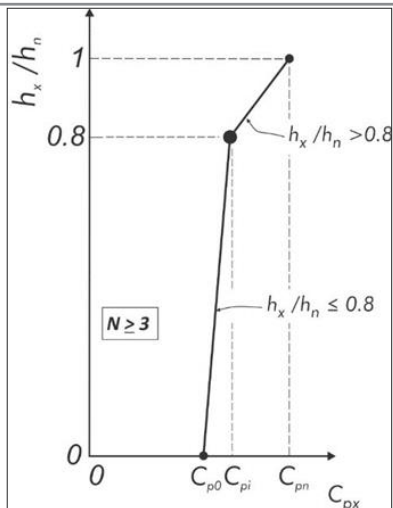

$$N = 6$$

$z_s = 1.0$ (all other SFRS, ASCE/SEI 7-22 Section 12.10.3.2.1)

$R_s = 2.0$ for concrete-filled metal deck floor diaphragm (ASCE/SEI 7-22 Table 12.10-1)

$R_s = 1.0$ bare steel deck roof diaphragm with welded connections not meeting special seismic detailing provisions (ASCE/SEI 7-22 Table 12.10-1)

$$C_s = 0.200 \text{ (Slide 39)}$$



FEMA



Building Seismic
Safety Council



Using this information and the calculated value of C_s from slide 39, we move forward with defining the F_{px} forces.

Alternative Design Method (Section 12.10.3)

First Mode Contribution Factor

$$\begin{aligned}\Gamma_{m1} &= 1 + 0.5z_s \left(1 - \frac{1}{N}\right) && \text{(Eq. 12.10-13)} \\ &= 1 + 0.5 \times 1.00 \times \left(1 - \frac{1}{6}\right) = 1.42\end{aligned}$$

Higher Mode Contribution Factor

$$\begin{aligned}\Gamma_{m2} &= 0.9z_s \left(1 - \frac{1}{N}\right)^2 \\ &= 0.9 \times 1.00 \times \left(1 - \frac{1}{6}\right)^2 \\ &= .625 && \text{(Eq. 12.10 - 14)}\end{aligned}$$

First Mode Contribution Factor

$$\begin{aligned}\Gamma_{m1} &= 1 + 0.5z_s \left(1 - \frac{1}{N}\right) && \text{(Eq. 12.10-13)} \\ &= 1 + 0.5 \times 1.00 \times \left(1 - \frac{1}{6}\right) = 1.42\end{aligned}$$

Higher Mode Contribution Factor

$$\begin{aligned}\Gamma_{m2} &= 0.9z_s \left(1 - \frac{1}{N}\right)^2 \\ &= 0.9 \times 1.00 \times \left(1 - \frac{1}{6}\right)^2 \\ &= .625 && \text{(Eq. 12.10 - 14)}\end{aligned}$$



FEMA

Building Seismic
Safety Council



From the variables just defined, we can calculate the first mode contribution factor and the higher mode contribution factor. Rather than just addressing the second mode, the higher-mode factor is intended to address all higher modes that provide a significant contribution.

Alternative Design Method (Section 12.10.3)

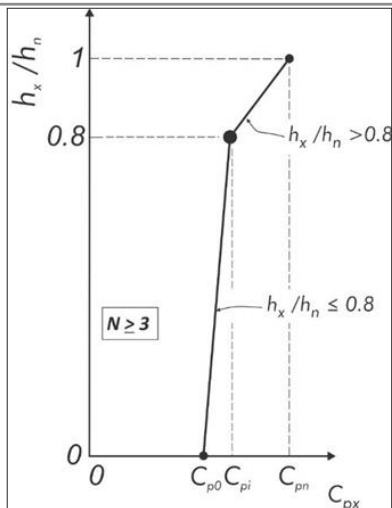

Higher Mode Response Coefficient C_{s2} is taken as the lesser of the following:

- $C_{s2} = (0.15N + 0.25)I_e S_{DS}$
- $= (0.15 \times 6 + 0.25) \times 1.0 \times 1.2 = 1.38$ (Eq. 12.10-10)
- $C_{s2} = I_e S_{DS} = 1.0 \times 1.2 = 1.2$ (Eq. 12.10-11)
- $C_{s2} = \frac{I_e S_{D1}}{0.03(N-1)} = \frac{1.0 \times 0.7}{0.03(6-1)} = 4.7$ (Eq. 12.10-12a)
- Use $C_{s2} = 1.2$



FEMA



Building Seismic
Safety Council



The higher mode response coefficient is then calculated as...

Alternative Design Method (Section 12.10.3)

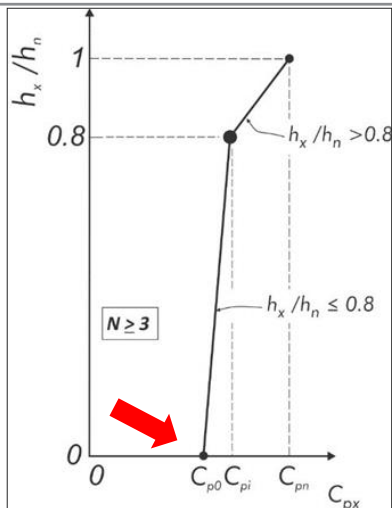

Diaphragm Design Acceleration Coefficient at the Structure Base

$$C_{p0} = 0.4S_{DS}I_e = 0.4(1.2)(1.00) = 0.48 \quad (\text{Eq 12.10-6})$$

Next, we calculate the three diaphragm design acceleration coefficients, C_{p0} , C_{pi} and C_{pn} that define the vertical distribution.

C_{p0} , at the base of the structure is calculated as:

Alternative Design Method (Section 12.10.3)

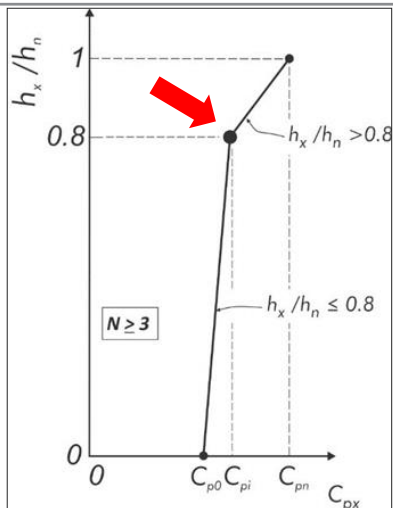

Diaphragm Design Acceleration Coefficient at 80% of the Structure Height

C_{pi} is taken as the greater of the following:

$$C_{pi} = C_{pi0} = 0.48 \quad (\text{Eq. 12.10-8})$$

$$C_{pi} = 0.9\Gamma_{m1}\Omega_0 C_s \quad (\text{Eq. 12.10-9})$$

$$= 0.9(1.42)(2.0)(0.200) = 0.51$$

Use $C_{pi} = 0.51$



FEMA



Building Seismic
Safety Council



C_{pi} at the bend in the vertical distribution is taken as...

Alternative Design Method (Section 12.10.3)

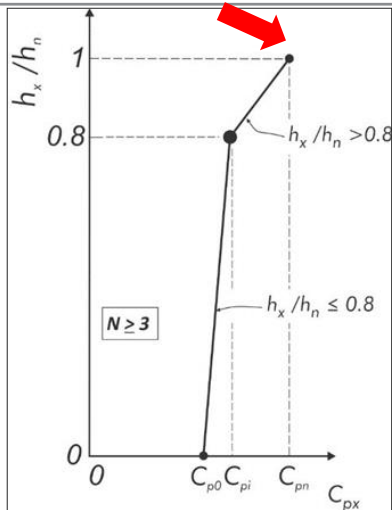

- Diaphragm Design Acceleration Coefficient at the Structure Height, h_n

$$C_{pn} = \sqrt{(\Gamma_{m1}\Omega_0 C_s)^2 + (\Gamma_{m2} C_{s2})^2}$$

$$C_{pn} = \sqrt{(1.42 \times 2 \times 0.200)^2 + (0.625 \times 1.2)^2}$$

$$= 0.94 \quad (\text{Eq. 12.10-7})$$



FEMA



Building Seismic
Safety Council



Finally, C_{pn} at the top of the structure is calculated...

Alternative Design Method (Section 12.10.3)

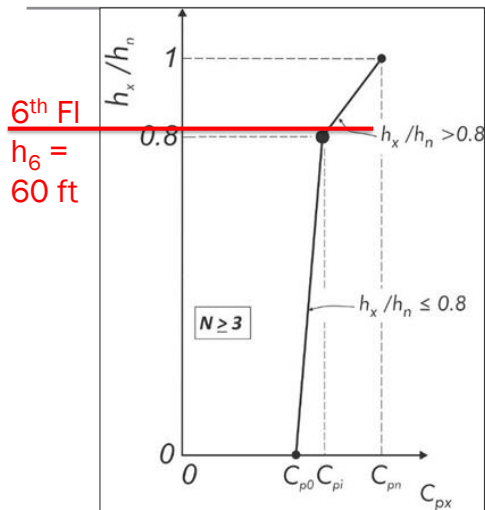

- $C_{\rho 0} = 0.48$
- $C_{\rho i} = 0.51$
- $C_{\rho n} = 0.94$
- $0.8h_n = 0.8(72 \text{ ft}) = 57.6 \text{ ft}$



FEMA



Building Seismic
Safety Council



Using the calculated values, the vertical distribution of diaphragm design forces is defined by...

A line is drawn showing the 6th floor relative to the vertical distribution, which falls between $C_{\rho i}$ and $C_{\rho n}$. Each level can be located and the applicable diaphragm design acceleration coefficient at that level, $C_{\rho x}$, can be calculated.

Alternative Design Method (Section 12.10.3)

Diaphragm Design Acceleration Coefficient at 6th Floor

$$h_6 = 5 (12) = 60 \text{ ft}$$

$$C_{p6} = 0.51 + (0.94 - 0.51) (60 - 57.6) / 12 = 0.60 \quad (\text{linear interpolation})$$

$$F_{p6} = \frac{C_{p6}}{R_s} w_{p6}$$
$$= \frac{0.60}{2.0} 1,570 = 471 \text{ kips}$$

But not less than:

$$F_{p6} = 0.2 S_{DS} I_e w_{px} \quad (\text{ASCE/SEI 7-22 Eq. 12.10-5})$$
$$= 0.2 (1.2) (1.0) (1,570) = 377 \text{ kips (floor)}$$



FEMA

Building Seismic
Safety Council



Putting this information together for the 6th floor concrete-filled steel deck diaphragm, we are able to calculate C_{p6} from the vertical distribution and using the previously identified w_{p6} of 1570 kips and R_s of 2.0, F_{p6} is calculated in accordance with ASCE/SEI 7-22 equation 12.10-4.

In addition, a lower bound for the F_{p6} force is provided per ASCE/SEI 7-22 equation 12.10-5.

Alternative Design Method (Section 12.10.3)

Table 7.5-4: Summary of Section 12.10.3 Alternative Diaphragm Design Forces, F_{px} , (kips)

Level	C_{pn}	F_{px} Eq. 12.10 4 Force (kips)	F_{px} Minimum (kips)	F_{px} Design (kips)
Roof	0.94	778	199	778
6	0.60	471	377	471
5	0.51	400	377	400
4	0.50	392	377	392
3	0.49	385	377	385
2	0.49	385	377	385

1.0 kip = 4.45 kN



FEMA

Building Seismic
Safety Council



Applying this method for the second floor through the roof, the F_{px} forces can be defined for each, as tabulated here.

Alternative Design Method (Section 12.10.3)

Step 5 – Diaphragm Transfer Forces

- Diaphragm transfer forces, as defined in ASCE/SEI 7-22 Section 11.2, occur where vertical elements of the SFRS are offset or discontinued at lower levels; they also occur due to changes in the stiffness of the SFRS vertical elements between levels. The occurrence of diaphragm transfer forces is determined by examining the distribution of forces from the analysis model.
- For simplicity, the building in this example building is assumed to not have diaphragm transfer forces.



FEMA



Building Seismic
Safety Council



Step 5 for the Alternative Design Provisions is the same as for the Traditional Method

Alternative Design Method (Section 12.10.3)

Step 6 – Design for Shear and Flexure

- Diaphragms at each level are designed for shear and flexure using the tabulated F_{px} design forces. Should diaphragm transfer forces be applicable these would also be included and be amplified where required (ASCE/SEI 7-22 Section 12.10.3.3).
- Where a computer analysis model is used, this can involve taking the shear and flexure forces at the F_x level from the model and amplifying them to the F_{px} level.
- For diaphragms idealized as rigid or semi-rigid, inherent torsion, accidental torsion and transfer forces are addressed in the building model such that the extracted shear and flexure forces include these effects.

Step 6 for the Alternative Design Provisions is the same as for the Traditional Method.

For the alternative Design Procedure, the requirement for amplification of transfer forces at Horizontal Irregularity Type 4 is found in ASCE/SEI Section 12.10.3.3.

Alternative Design Method (Section 12.10.3)

Step 7 - Collector Seismic Design Forces

Collectors in the example building are, per ASCE/SEI 7-22 Section 12.10.3.4, required to be designed for amplified seismic forces. In lieu of the overstrength requirements of ASCE/SEI 7-22 Section 12.10.2.1, the collectors are required to be amplified by a factor of 1.5. Just like the seismic load effect with overstrength provisions of ASCE/SEI 7-22 Section 12.4.3, the amplified forces are required to be used in the appropriate load combinations from ASCE/SEI 7-22 Chapter 2. The following demonstrates the calculation of the collector seismic design forces due to horizontal seismic loads. This will need to be combined with applicable gravity loads and vertical seismic forces.

The overstrength force level for collectors and their connections to vertical elements applies when using the Alternative Design Procedure. The overstrength factor, however, is defined in ASCE/SEI 7-22 Section 12.10.3.4, rather than being defined by the vertical elements of the SFRS and Table 12.2-1

Alternative Design Method (Section 12.10.3)

Diaphragm Transverse Force Reactions and Units Shears

Roof Diaphragm $V = 778 \text{ kips} / 2 = 389 \text{ kips}$

$$v = 389 \text{ kips} / 120 \text{ ft} \\ = 3.24 \text{ klf}$$

5th Flr diaphragm $V = 400 (1.1) \text{ kips} / 2$

$$= 220 \text{ kips} \\ v = 220 \text{ kips} / 120 \text{ ft} \\ = 1.83 \text{ klf}$$

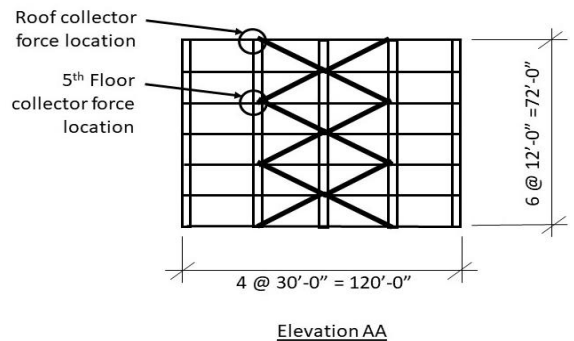

Using the same assumptions as for the Traditional Design Method and the F_{px} forces calculated using the Alternative Design Procedure, the unit shears at the edges of the 5th floor and roof diaphragms are calculated as....

Alternative Design Method (Section 12.10.3)

- Collector Force at Location shown in Figure, amplified by 1.5 (in lieu of Ω_0)
- Roof Diaphragm $T/C = 3.24 \text{ klf (30 ft) (1.5) = 146 \text{ kips}$
- 5th Floor Diaphragm $T/C = 1.83 \text{ klf (30 ft) (1.5) = 82 \text{ kips}$



FEMA



Building Seismic
Safety Council



Using the procedures of ASCE/SEI 7-22 Section 12.10.3.4, the collector forces are calculated as....

Alternative Design Method (Section 12.10.3)

Step 8 – Deflection and Drift Requirements

For ELF design, this step incorporates the revised displacement and drift determination provisions of ASCE/SEI 7-22 Section 12.8.6 and the drift and deformation provisions of Section 12.12.

The structural separation provisions of Section 12.12.2, structural separation requirements of Section 12.12.3, and deformation compatibility provisions of 12.12.4 each require that diaphragm deflection be considered in addition to the deflection of the vertical elements.

Step 8 for the Alternative Design Provisions is the same as for the Traditional Method.

Example Multi-Story Steel Building with Steel Deck Diaphragms

Comparison of Methods



FEMA

 Building Seismic
Safety Council



Comparison of Design Methods

Table 7.5-5: Comparison of Traditional and Alternative F_{px} Diaphragm Design Forces (kips)

Level	F_{px} Traditional ASCE/SEI 7 22 Section 12.10.1 and 12.10.2 (kips)	F_{px} Alternative ASCE/SEI 7 22 Section 12.10.3 (kips)
Roof	302	778 ($R_s = 1.0$)
6	510	471
5	460	400
4	411	392
3	377	385
2	377	385

1.0 kip = 4.45 kN



FEMA



Building Seismic
Safety Council



This table compares the diaphragm design forces from this example.

Comparison of Design Methods

For this structure and the diaphragm systems used, the alternative method force is higher than the traditional method at some diaphragm levels (particularly at the roof), and lower at others. The much higher diaphragm design force at the roof comes from the combination of using the alternative method, and the very low values of $R_s = 1.0$ for the welded bare steel deck diaphragm that is recognized in the ASCE/SEI 7-22 to have low ductility. If the roof diaphragm were instead changed to conform to the special seismic detailing requirements, the roof diaphragm design forces would essentially match the traditional method forces.

Comparison of Design Methods

Table 7.5-6: Comparison of Traditional and Alternative Diaphragm Collector Forces

Level	Traditional ASCE/SEI 7 22 Section 12.10.1 and 12.10.2 (kips)	Alternative ASCE/SEI 7 22 Section 12.10.3 (kips)
Roof	76	146 ($R_s = 1.0$)
5	127	82

1.0 kip = 4.45 kN, 1.0 ft = 0.3048 m, 1.0 ft-kip = 1.36 kN-m



FEMA

Building Seismic
Safety Council



This table compares the collector forces. This outcome is similar.

Part 1 Closing Comments



FEMA



Building Seismic
Safety Council



Questions



This slide is intended to initiate questions from participants.

DISCLAIMER

- NOTICE: Any opinions, findings, conclusions, or recommendations expressed in this publication do not necessarily reflect the views of the Federal Emergency Management Agency. Additionally, neither FEMA, nor any of its employees make any warranty, expressed or implied, nor assume any legal liability or responsibility for the accuracy, completeness, or usefulness of any information, product or process included in this publication.
- The opinions expressed herein regarding the requirements of the *NEHRP Recommended Seismic Provisions*, the referenced standards, and the building codes are not to be used for design purposes. Rather the user should consult the jurisdiction's building official who has the authority to render interpretation of the code.
- This training material presentation is intended to remain complete in its entirety even if used by other presenters. While the training material could be tailored for use in other presentations, we caution users to account for issues of completeness and interpretation if only part of the material is used. We also strongly suggest users give proper credit/citation to this presentation and its author.



FEMA

 Building Seismic
Safety Council



Chapter 7 – Part 2

Horizontal Diaphragm Design

2020 NEHRP Provisions Training Materials

Kelly Cobeen S.E., *Wiss Janney Elstner Associates*



FEMA



Building Seismic
Safety Council

| BSSC



Welcome to 2020 *NEHRP Provisions* training, Chapter 7 addressing Horizontal diaphragm design. This training is presented in two parts.

Part 1 provides an introduction and presents an example problem with a multi-story steel building with steel deck diaphragms. Part 1 is anticipated to take approximately 90 minutes to present including question and answer sessions.

Part 2 presents an example problem with a single-story large-box building with tilt-up walls and a flexible diaphragm. Part 2 is anticipated to take approximately 60 minutes to present, including a question-and-answer session.

Both examples incorporate the 2020 NEHRP Provisions as incorporated into ASCE/SEI 7-22.

Example One-Story RWFD Building with Bare Steel Deck Diaphragm



FEMA

 Building Seismic
Safety Council



Part 2 presents an example one story rigid wall flexible diaphragm building with bare steel deck.

Diaphragm Design Presentation Outline – Part 2

- Example one-story RWFD building with steel deck diaphragm
 - Section 12.10.1 and 12.10.2 *Traditional Design Method*
 - Section 12.10.4 *Alternative RWFD Design Method*
 - Comparison of results

This presentation will cover determination of diaphragm design forces using both the Traditional Design Methods of Sections 12.10.1 and 12.10.2 and the Alternative RWFD Method of Section 12.10.4. The ASCE/SEI 7-22 title for this section is: “Alternative Diaphragm Design Provisions for One-Story Structures with Flexible Diaphragms and Rigid Vertical Elements.”

Example One-Story RWFD Building with Steel Deck Diaphragm

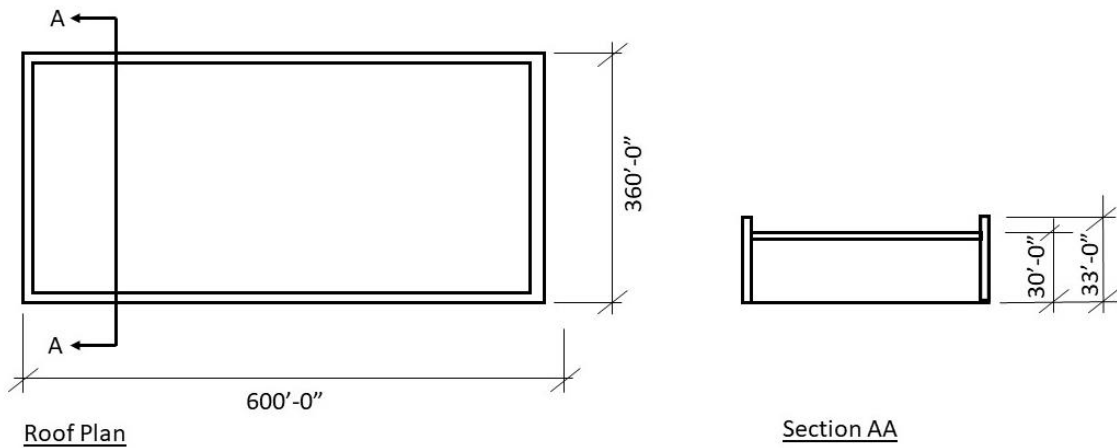

This design example will show a very common occurrence of this building type – a large footprint single-story building with tilt-up concrete perimeter walls and a flexible diaphragm. For the example, the diaphragm is of bare steel deck. The simple rectangular plan and a typical section are shown in the figures above.

Example One-Story RWFD Building with Steel Deck Diaphragm

Building Configuration

- One story
- $I_e = 1.0$
- Mean roof height = 30 feet
- Length = 600 feet
- Width = 360 feet
- $S_{DS} = 1.0$, $S_{D1} = 0.50$ (ASCE/SEI 7-22 Section 11.4.4)
- Bare steel deck diaphragm
- Intermediate precast concrete shear walls - $R=4$, $W_0=2.5$, $C_d=4$

Particulars of the building configuration and seismic design parameters are....

Example One-Story RWFD Building with Steel Deck Diaphragm

The system includes a bare steel deck diaphragm supported on open-web steel joists and girders. The perimeter walls are 9-1/4-inch-thick tilt-up concrete walls, with a mean roof height of 30 feet, and a parapet above the roof of 3 feet.

For purposes of design, the diaphragm will be categorized as flexible:

- When using Section 12.10.1 and 12.10.2 provisions, Section 12.3.1.1 permits the combination of bare steel deck and concrete walls to be idealized as flexible.
- When using Section 12.10.4, diaphragms meeting the applicable limitations of Section 12.10.4.1 are automatically considered flexible and able to use the flexible diaphragm-based provisions of Section 12.10.4.



FEMA

 Building Seismic Safety Council



Example One-Story RWFD Building with Steel Deck Diaphragm

Step 1 - Weight for Seismic Analysis

Roof D = 20 psf

Wall D = 116 psf

Wall seismic weight tributary to roof:

$w = 116 (33)(33/2)/30 = 2,105 \text{ plf}$

Seismic weight - Roof: $0.02 \text{ ksf} (600 \text{ ft}) (360 \text{ ft}) = 4,320 \text{ kips}$

Longitudinal walls: $(2.105 \text{ klf})(600 \text{ ft})(2 \text{ sides}) = 2,526 \text{ kips}$

Transverse walls: $(2.105 \text{ klf})(360 \text{ ft})(2 \text{ sides}) = 1,516 \text{ kips}$

TOTAL = 8,362 kips acting at roof



FEMA

Building Seismic
Safety Council



Step 1 takes the information about the building configuration and identifies seismic weights for use in design...

Example One-Story RWFD Building with Steel Deck Diaphragm

Step 1 - Diaphragm Weight, w_{px} , at the Roof

$$\begin{aligned}w_{px} &= \text{Total seismic weight} - \text{weight of the walls resisting seismic forces} \\ &= 8,362 - 1,516 = 6,846 \text{ kips (for seismic forces in transverse direction)} \\ &= 8,362 - 2,526 = 5,836 \text{ kips (for seismic forces in longitudinal direction)}\end{aligned}$$

When designing this type of low-rise building with heavy exterior walls it is common practice to subtract the weight of the walls parallel to the seismic design direction from the seismic weight w_{px} . This is because the wall weight is understood to not be carried by the diaphragm, it originates in the walls and is resisted by the walls.

Example One-Story RWFD Building with Steel Deck Diaphragm

Step 2 - Base Shear

$$T_a = C_t h_n^x = 0.020(30)^{0.75} = 0.26 \text{ sec} \quad (\text{ASCE/SEI 7-22 Eq. 12.8-7})$$

$$C_s = \frac{S_{DS}}{R/I_e} = \frac{1.0}{4/1.0} = 0.250 \quad (\text{ASCE/SEI 7-22 Eq. 12.8-2})$$

C_s need not exceed:

$$C_s = \frac{S_{D1}}{T(R)/I_e} = \frac{0.50}{0.26(4)/1.0} = 0.481 \quad (\text{ASCE/SEI 7-22 Eq. 12.8-3})$$

$$\text{Base Shear } V = C_s W = (0.250)(8,362) = 2,090 \text{ kips} \quad (\text{ASCE/SEI 7-22 Eq. 12.8-1})$$



FEMA

Building Seismic
Safety Council



Using the equations of ASCE/SEI 7-22 Section 12.8, the seismic base shear can be calculated...

Example One-Story RWFD Building with Steel Deck Diaphragm

Traditional Design Method (12.10.1 & 12.10.2)



FEMA



Building Seismic
Safety Council



95

From this point forward, the Traditional Design Method and the Alternative RWFD Provisions start to diverge. We will complete the traditional design method first and follow up with the Alternative RWFD Provisions.

Traditional Design Method

Step 4 - Strength Level diaphragm design force:

$$F_{px} = \frac{\sum_{i=x}^n F_i}{\sum_{i=x}^n W_i} w_{px} \quad (\text{ASCE/SEI 7-22 Eq. 12.10-1})$$

For a single-story building, $F_{px} = C_s (w_{px})$

$$\begin{aligned} F_{px} &= C_s (w_{px}) \\ &= 0.25 (6,846) = 1,712 \text{ kips (transverse direction)} \\ &= 0.25 (5,836) = 1,459 \text{ kips (longitudinal direction)} \end{aligned}$$



FEMA

Building Seismic
Safety Council



Step 3 in the diaphragm design process addresses vertical distribution of F_x forces. This is not applicable for our one-story building.

Moving on with the Section 12.10.1 and 12.10.2 traditional design method, Step 4 calculated the diaphragm F_{px} forces. Again, vertical distribution is not applicable. The diaphragm design forces are determined as C_s times w_{px} . Note that the w_{px} value that deducts the weight of walls parallel to the direction of seismic load is carried through this calculation, resulting in different design forces in the longitudinal and transverse directions.

Traditional Design Method

The minimum value of F_{px} is:

$$\begin{aligned} F_{px} &= 0.2S_{DS}I_eW_{px} && \text{(ASCE/SEI 7-22 Eq. 12.10-2)} \\ &= 0.2(1.0)(1.0)(6,846) = 1,369 \text{ kips (transverse direction)} \\ &= 0.2(1.0)(1.0)(5,836) = 1,167 \text{ kips (longitudinal direction)} \end{aligned}$$

The maximum value of F_{px} is:

$$\begin{aligned} F_{px} &= 0.4S_{DS}I_eW_{px} && \text{(ASCE/SEI 7-22 Eq. 12.10-3)} \\ &= 0.4(1.0)(1.0)(6,846) = 2,738 \text{ kips (transverse direction)} \\ &= 0.4(1.0)(1.0)(5,836) = 2,334 \text{ kips (longitudinal direction)} \end{aligned}$$



FEMA

Building Seismic
Safety Council



It is necessary to also check the upper and lower bounds of the diaphragm design forces using ASCE/SEI 7-22 equations 12.10-2 and 12.10-3. These are calculated as....

Traditional Design Method

Step 4 - Governing diaphragm design force

$F_{px} = 1,712$ kips (transverse direction)

$F_{px} = 1,459$ kips (longitudinal direction)



FEMA

 Building Seismic
Safety Council



The result of Step 4 is the following F_{px} forces to be used for diaphragm design...

Traditional Design Method

Step 6 - Diaphragm Design for Shear

The diaphragm is design for shear using F_{px} forces. The following illustrates shear calculations for the transverse direction.

For transverse roof diaphragm forces:

$$w = 1,712 \text{ kips} / 600 \text{ ft} = 2.85 \text{ klf}$$

$$V = 2.85 \text{ klf} (600 \text{ ft} / 2) = 856 \text{ kips}$$

$$v = 856 \text{ kips} / 360 \text{ ft} = 2.37 \text{ klf maximum at end of diaphragm span}$$

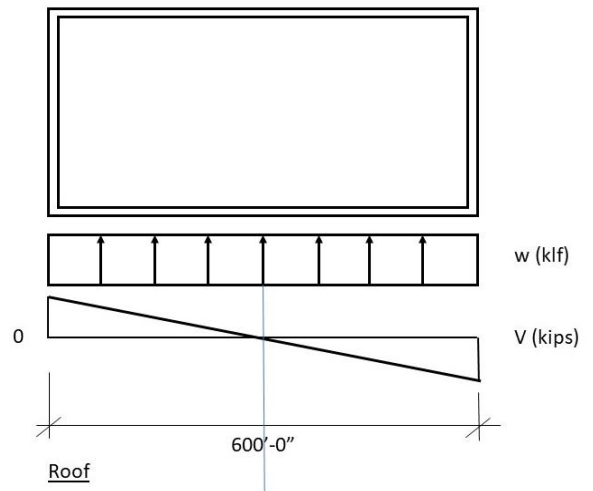

FEMA

Building Seismic
Safety Council



Step 5 in the process addresses transfer forces. Transfer forces are not applicable to one-story buildings and so are skipped in this example.

Step 6 involves diaphragm design for shear and flexure. For design for forces in the transverse direction, the F_{px} forces can be turned into a uniformly distributed load as shown in the figure at the right. From this the diaphragm shear reactions can be calculated and translated into unit shear forces in plf.

This is repeated in the longitudinal direction.

Traditional Design Method

Step 6 - Diaphragm Design for Flexure

For transverse roof diaphragm forces:

$$w = 1,712 \text{ kips} / 600 \text{ ft} = 2.85 \text{ klf}$$

$$M = 2.85 \text{ klf} (600 \text{ ft})^2 / 8 = 128,250 \text{ kip-ft}$$

$$\text{Chord } T/C = 128,250 \text{ kip-ft} / 360 \text{ ft} = 356 \text{ kips maximum at diaphragm mid-span}$$

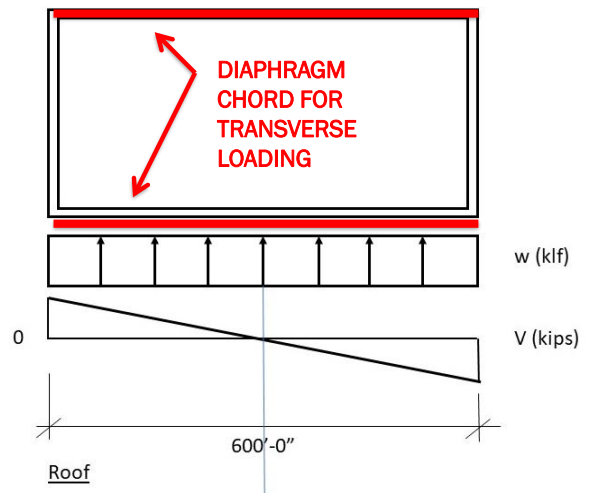

Design for flexure uses the same uniformly distributed loads to calculate moment and mid-span of the diaphragm. It is assumed that this is resisted by a tension chord at one edge of the diaphragm and a compression chord at the other, as shown in the graphic. The tension and compression sides reverse with reversing earthquake loading. The chord tension and compression forces can be calculated as....

For a steel deck diaphragm, a structural steel member will often be provided to serve as the diaphragm chord. In this case a member with a fairly substantial section area will be required.

Traditional Design Method

Step 7 - Diaphragm Collector Design with Seismic Forces Amplified by Ω_0

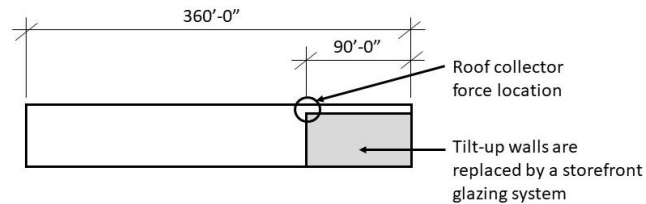

Wall Elevation

The collector force is calculated based on the maximum transverse diaphragm shear, amplified by Ω_0 :

- $T/C = 2.37 \text{ klf} (90 \text{ ft}) (2.5) = 533 \text{ kips}$



FEMA

Building Seismic
Safety Council



Step 7 addresses calculation of design forces for collectors and their connections to vertical element.

For this problem it is assumed that for a length of approximately 90 feet at one corner as shown above, the concrete tilt-up panels are replaced with a storefront glazing system. At this location a collector will need to be provided to pull the unit shear forces from the edge of the diaphragm into the tilt-up walls beyond. The collector force can be calculated as....The overstrength factor in this cases is taken from Table 12.2-1 based on intermediate precast concrete wall vertical system.

Traditional Design Method

Step 8 - Deflection and Drift Limitations.

- All applicable ASCE/SEI 7-22 deflection and drift checks are to be completed. It is important that this include a check that the gravity system can accommodate the mid-span deflection of the roof diaphragm, and the P-D stability of the tilt-up wall panels when subject to the diaphragm deflection .
- See the commentary to the ASCE/SEI 7-22 Section 12.10.4 provisions for further discussion of these checks



Example One-Story RWFD Building with Steel Deck Diaphragm

Alternative RWFD Design Method (12.10.4)

Meeting AISI S400 Special Seismic Detailing Requirements



FEMA

Building Seismic
Safety Council



103

We will now go through diaphragm design for the same building using the Section 12.10.4 Alternative RWFD Provisions.

As noted in the subtitle, we will first look at design using a bare steel deck diaphragm system that conforms to the AISI S400 provisions for special seismic details. We will follow up with a second design for a diaphragm design that does not. The specifics of the special seismic detailing will be discussed in more detail in a few slides.

Diaphragm Seismic Design Methods

- Advantages of using Section 12.10.3 Alternative Design Provisions:
 - Better reflects vertical distribution of diaphragm forces
 - Better reflects affect of diaphragm ductility and displacement capacity
 - May result in lower seismic demands
- Advantages of using Section 12.10.4 Alternative RWFD Method;
 - Better reflects seismic response of RWFD buildings
 - May result in lower seismic demands
 - Is anticipated to result in better performance
- When will the Section 12.10.1 and 12.10.2 Traditional Method result in lower design forces?
 - Bare steel deck diaphragms not meeting the AISI S400 special seismic detailing provisions
 - Other



FEMA

 Building Seismic
Safety Council



As a reminder from the presentation introduction, some of the advantages of design in accordance with the Section 12.10.4 diaphragm design provisions include....

Alternative RWFD Design Method (Meeting Special Seismic Detailing Requirements, 12.10.4)

Step 1 - Check ASCE/SEI 7-22 Section 12.10.4.1 Scoping Limitations

The following are the scoping limitations that must be checked. If the building conforms to all scoping limitations, it is eligible to use the ASCE/SEI 7-22 Section 12.10.4 procedure.

1. All portions of the diaphragm shall be designed using the provisions of this section in both orthogonal directions.
2. The diaphragm shall consist of either a) a wood structural panel diaphragm designed in accordance with AWC SDPWS and fastened to wood framing members or wood nailers with sheathing nailing in accordance with the AWC SDPWS Section 4.2 nominal shear capacity tables, or b) a bare (untopped) steel deck diaphragm meeting the requirements of AISI S400 and AISI S310 .
3. Toppings of concrete or similar materials that affect diaphragm strength or stiffness shall not be placed over the wood structural panel or bare steel deck diaphragm.



FEMA

Building Seismic
Safety Council



The steps used to design the diaphragm using Section 12.10.4 are distinctly different from Sections 12.10.1 and 12.10.2 Traditional Method, and as a result are numbered differently.

Before starting to implement the Alternative RWFD design provisions of Section 12.10.4, it is necessary to check the limitations of Section 12.10.4.1 to make sure that the structure qualifies for use of this method. Section 12.10.4.1 includes a list of 7 limitations. They are...

Alternative RWFD Design Method (Meeting Special Seismic Detailing Requirements, 12.10.4)

- The diaphragm shall not contain horizontal structural irregularities, as specified in ASCE/SEI 7-22 Table 12.3-1, except that Horizontal Structural Irregularity Type 2 (reentrant corner irregularity) is permitted.
- The diaphragm shall be rectangular in shape or shall be divisible into rectangular segments for purpose of seismic design, with vertical elements of the seismic force-resisting system or collectors provided at each end of each rectangular segment span.

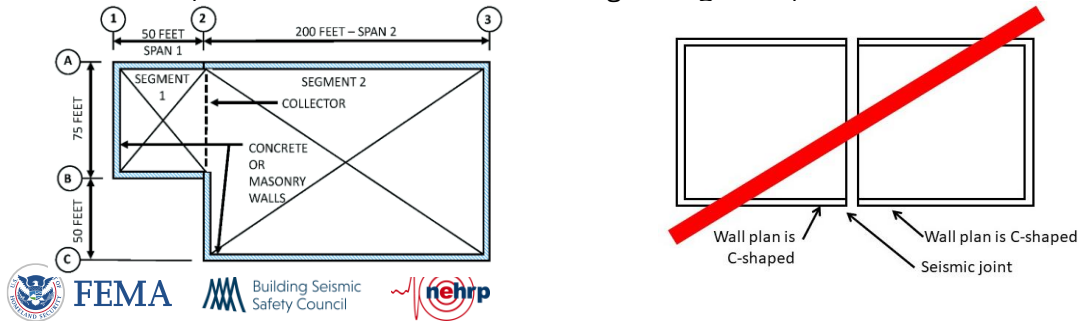

For Item 4...

For Item 5 – the diagram below shows a non-rectangular building being divided into multiple rectangles for purposes of diaphragm design. Each edge of each segment must be supported by vertical elements or by collectors that extend to vertical elements, as seen in the left figure.

The right figure shows a plan configuration though to be somewhat prevalent in the eastern states. A large plan building is constructed using two segment separated by a seismic joint. Each segment only has walls or other vertical elements on three sides and no vertical element is provided to support the diaphragm at the line of the seismic joint. The result is a c-shaped configuration in plan, and a very long span diaphragm cantilever. This does not meet the criteria of Item 5 and this configuration cannot be designed using the Alternative RWFD provisions.

The ASCE/SEI 7-22 commentary provides examples of plan configurations for which this design method is not applicable.

Alternative RWFD Design Method (Meeting Special Seismic Detailing Requirements, 12.10.4)

6. The vertical elements of the seismic force-resisting system shall be limited to one or more of the following: concrete shear walls, precast concrete shear walls, masonry shear walls, steel concentrically braced frames, steel and concrete composite braced frames, or steel and concrete composite shear walls.
7. The vertical elements of the seismic force-resisting system shall be designed in accordance with ASCE/SEI 7-22 Section 12.8, except that they shall be permitted to be designed using the two-stage analysis procedure of ASCE/SEI 7-22 Section 12.2.3.2.2, where applicable.

The example building conforms to all of these limitations and can be designed in accordance with ASCE/SEI 7-22 Section 12.10.4.

Alternative RWFD Design Method (Meeting Special Seismic Detailing Requirements, 12.10.4)

Step 2 - Break roof diaphragm into a series of rectangular segments for purposes of design with each segment spanning to vertical elements or a collector .

- Because the example building is rectangular in plan and shear walls are located at the building perimeter, a single rectangular segment extending for the full building plan (600 ft by 360 ft) will be used.

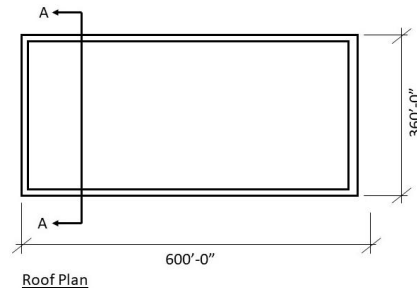

FEMA

Building Seismic
Safety Council



If the building is not rectangular in plan, see the ASCE/SEI 7-22 commentary for discussion of how it might be broken into rectangular elements for the purposes of design. Buildings with walls that are angled or curved in plan are not intended to be designed using this method.

Alternative RWFD Design Method (Meeting Special Seismic Detailing Requirements, 12.10.4)

Step 3 - Determine W_{px}

W_{px} was determined in previous slides to be:

6,846 kips (transverse forces)

5,836 kips (longitudinal forces)

Step 3 involves determining W_{px} forces. These are the same as was determined for the Section 12.10.1 and 12.10.2 Traditional Design Method.

Alternative RWFD Design Method (Meeting Special Seismic Detailing Requirements, 12.10.4)

Step 4 - Determine R_{diaph}

Section 12.10.4.2.1:

$R_{diaph} = 4.5$ for bare steel deck diaphragms that meet the special seismic detailing requirements of AISI S400 Section F3.5.1.



FEMA



Building Seismic
Safety Council



Step 4 involves the determination of the response modification coefficient for design of diaphragms, R_{diaph} . This is found in ASCE/SEI 7-22 Section 12.10.4.2.1. This is a new variable that applies explicitly to the design of the diaphragm. It is derived from research including analytical studies to confirm resulting seismic performance can be anticipated to be in line with the intent of ASCE 7 and the building code.

The R_{diaph} factor is set as 4.5 for wood structural panel diaphragms. For bare steel deck diaphragms, however, it is necessary to determine whether the diaphragm meets the AISI S400 requirements for special seismic detailing in order to assign the R_{diaph} .

Alternative RWFD Design Method (Meeting Special Seismic Detailing Requirements AISI S400 Section F3.5.1)

Item	Prescriptive Requirements
1	The steel deck panel type shall be 36 in. (914 mm) wide, 1.5 in. (38.1 mm) deep wide rib, 6 in. (152 mm) pitch (WR) deck.
2	The steel deck base steel thickness shall be greater than or equal to 0.0295 in. (0.749 mm) and less than or equal to 0.0598 in. (1.52 mm).
3	The steel deck material shall conform to Section A.3.1.1 of AISI S100 [CSA S136].
4	The structural connection between the steel deck and the supporting steel member (with minimum thickness of 1/8 in. (3.18 mm)) shall be limited to mechanical connectors qualified in accordance with AISI S400 Section F3.5.1.1.



FEMA

Building Seismic
Safety Council



111

The easiest method to meet the special seismic detailing provisions is by using the prescriptive provisions for bare steel deck with mechanical fasteners. There are 8 requirements that need to be met, shown in the table above and the following slides.

These are...

Alternative RWFD Design Method (Meeting Special Seismic Detailing Requirements AISI S400 Section F3.5.1)

Item	Prescriptive Requirements
5	The structural connection perpendicular to the steel deck ribs shall be no less than a 36/4 pattern (12 in. (305 mm) on center) and no more than a 36/9 pattern (6 in. (152mm) on center) with double fasteners in the last panel rib.
6	The structural connection parallel to the steel deck ribs shall be no less than 3 in. (76.2 mm) and no more than 24 in. (610 mm) and shall not be greater than the sidelap connection spacing.
7	The sidelap connection between steel deck shall be limited to #10, #12, or #14 screws sized such that shear in the screws is not the controlling limit state, or connectors qualified in accordance with AISI S400 Section F3.5.1.2.



FEMA



Building Seismic
Safety Council



These are...

Alternative RWFD Design Method (Meeting Special Seismic Detailing Requirements AISI S400 Section F3.5.1)

Item Prescriptive Requirements

- 8 The sidelap connection shall be spaced no less than 6 in. (152 mm) and no more than 24 in. (610 mm).

Impact of Prescriptive Requirements:

- Requires mechanical fasteners
- Welded connections not permitted under prescriptive requirements

Other AISI methods:

- Qualification by testing – AISI S400 Section F3.5.2.1
- Principles of mechanics – AISI S400 Section F3.5.2.2



FEMA

Building Seismic
Safety Council



113

Finally, Item 8 is...

Welded connections do not satisfy these prescriptive special seismic detailing provisions. Other methods are available by which welded connections might be able to be qualified in the future, including qualification by testing and principles of mechanics.

Again, for this example we will use a mechanical connection system that meets the special seismic detailing requirements, and so qualify for $R_{diaph} = 4.5$.

Alternative RWFD Design Method (Meeting Special Seismic Detailing Requirements, 12.10.4)

Step 5- Determine T_{diaph}

- $T_{diaph} = 0.001L_{diaph}$ for bare steel deck diaphragms (ASCE/SEI 7-22 Section 12.10.4.2.1)
- $T_{diaph} = 0.001 (600) = 0.60$ s (transverse forces)
- $T_{diaph} = 0.001 (360) = 0.36$ s (longitudinal forces)

Step 5 involves the calculation of the diaphragm period. Fundamental to the alternative method is recognition that the seismic response of this building type is governed by the long period response of the diaphragm. T_{diaph} is used to explicitly incorporate this into the design process.

The formula provided comes from research and is a function of the diaphragm span. Because the diaphragm span is different in the transverse and longitudinal directions, we get a separate period for each direction.

Alternative RWFD Design Method (Meeting Special Seismic Detailing Requirements, 12.10.4)

Step 6 - Determine $C_{s-diaph}$

For transverse forces:

$$C_{s-diaph} = \frac{S_{DS}}{R_{diaph} / I_e} = \frac{1.0}{4.5 / 1.0} \Rightarrow 0.222 \quad (\text{ASCE/SEI 7-22 Eq. 12.10-16a})$$

But need not exceed

$$C_{s-diaph} = \frac{S_{D1}}{T_{diaph} (R_{diaph}) / I_e} = \frac{0.50}{0.60(4.5) / 1.0} = 0.185 \quad (\text{ASCE/SEI 7-22 Eq. 12.10-16b})$$

Use $C_{s-diaph} = 0.185$ transverse



FEMA

Building Seismic
Safety Council



With R_{diaph} and T_{diaph} determined, the seismic design coefficient $C_{s-diaph}$ can be calculated. This is again a new variable that is explicitly for use in diaphragm design and is at the heart of the Alternative RWFD Provision methodology. First $C_{s-diaph}$ is determined for the transverse direction seismic loads.

In seeing equation 12.10-16b provide the controlling value for $C_{s-diaph}$ in the transverse direction we are directly seeing the impact of the Alternative RWFD provisions and recognition of the long-period (off plateau) response of the structure.

Alternative RWFD Design Method (Meeting Special Seismic Detailing Requirements, 12.10.4)

For longitudinal forces:

$$C_{s-diaph} = \frac{S_{DS}}{R_{diaph}/I_e} = \frac{1.0}{4.5/1.0} = 0.222 \quad (\text{ASCE/SEI 7-22 Eq. 12.10-16a})$$

But need not exceed:

$$C_{s-diaph} = \frac{S_{D1}}{T_{diaph}(R_{diaph})/I_e} = \frac{0.50}{0.36(4.5)/1.0} = 0.309 \quad (\text{ASCE/SEI 7-22 Eq. 12.10-16b})$$

Use $C_{s-diaph} = 0.222$ longitudinal



FEMA

Building Seismic
Safety Council



Next, the same is determined for the transverse loads. In this instance, because of the shorter diaphragm span in the longitudinal direction, T_{diaph} is smaller and as a result equation 12.10-16a (plateau) winds up controlling the value of $C_{s-diaph}$.

Alternative RWFD Design Method (Meeting Special Seismic Detailing Requirements, 12.10.4)

Step 7 - Determine diaphragm design force, F_{px}

- $F_{px} = C_{s-diaph} (W_{px})$ (ASCE/SEI 7-22 Eq.12.10-15)
- $F_{px} = 0.185 (6,846) = 1,266$ kips transverse
- $F_{px} = 0.222 (5,836) = 1,296$ kips longitudinal

Note that unlike the ASCE/SEI 7-22 Section 12.10.1 and 12.10.2 traditional method and the Section 12.10.3 alternative method, for the Section 12.10.4 alternative RWFD method there is no lower bound for diaphragm seismic design forces.



FEMA

Building Seismic
Safety Council



In step 7 the F_{px} forces can now be calculated...

Alternative RWFD Design Method (Meeting Special Seismic Detailing Requirements, 12.10.4)

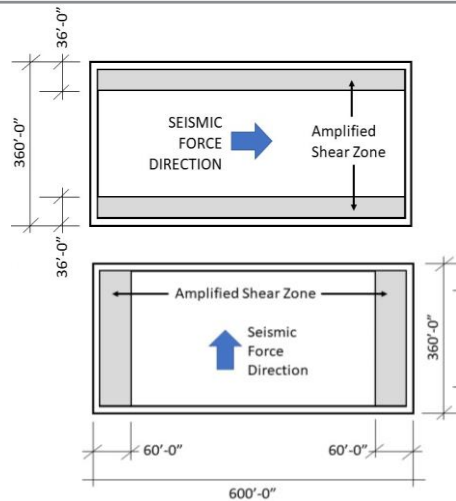

Step 8 - Determine amplified shear and extent of amplified shear boundary zone

- Because the diaphragm span in both directions is greater than 100 ft., an amplified shear zone will be located at each end of the diaphragm span and extend for ten percent of the diaphragm span. The extent of the amplified shear zones are:
 - $0.10 (600) = 60$ ft each end for transverse forces
 - $0.10 (360) = 36$ ft each end for longitudinal forces.



FEMA

Building Seismic Safety Council



Where diaphragm spans are over 100 feet, as occurs in both the transverse and longitudinal direction in this example, amplified shear boundary zones are provided at each end of the diaphragm span over a length of 10% of the diaphragm span. This is true for loading in both orthogonal directions. The upper diagram shows the amplified shear boundary zone for loading in the longitudinal direction, while the lower diagram shows the transverse direction.

Alternative RWFD Design Method (Meeting Special Seismic Detailing Requirements, 12.10.4)

Step 9 - Diaphragm Design for Shear

- The diaphragm is designed for shear using F_{px} forces. The following illustrates shear calculations for the transverse direction.
- For transverse roof diaphragm forces:
- $w = 1,266 \text{ kips} / 600 \text{ ft} = 2.11 \text{ klf}$
- $V = R = 2.11 \text{ klf} (600 \text{ ft} / 2) = 633 \text{ kips}$
- $v = 633 \text{ kips} / 360 \text{ ft} = 1.76 \text{ klf}$ maximum at end of diaphragm span WITHOUT shear amplification
- $v = 1.76 \text{ klf} (1.5) = 2.64 \text{ klf}$ maximum at end of diaphragm span WITH shear amplification
- Using R (presumably for reaction) is a bit confusing since there already is an R for the Response Modification Coefficient. Typical.

Next, the diaphragm is designed for shear....

Alternative RWFD Design Method (Meeting Special Seismic Detailing Requirements, 12.10.4)

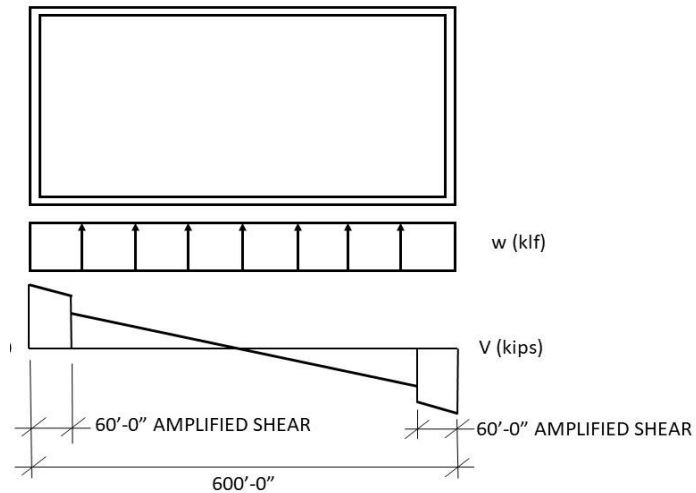

FEMA

Building Seismic
Safety Council



The resulting shear diagram for seismic forces in the transverse direction is shown in this figure. The step in shear at the amplified shear zones can be seen at either end of the span. With the shear diagram determined, the specifics of the diaphragm decking and fastening can be determined.

Alternative RWFD Design Method (Meeting Special Seismic Detailing Requirements, 12.10.4)

Step 9 - Diaphragm Design for Flexure

- For transverse roof diaphragm forces the chord force is calculated using F_{px} forces without amplification:
- $w = 1,266 \text{ kips} / 600 \text{ ft} = 2.11 \text{ klf}$
- $M = 2.11 \text{ klf} (600 \text{ ft})^2 / 8 = 94,950 \text{ kip-ft}$
- Chord $T/C = 94,950 \text{ kip-ft} / 360 \text{ ft} = 264 \text{ kips}$ maximum at diaphragm mid-span



Step 9 addresses the diaphragm design for flexure. The moment at diaphragm mid-span is first calculated and then resolved into a tension and compression couple acting at the diaphragm chord members. The diaphragm design forces used to calculate the moment do NOT include the amplified shear zone forces and do not include any consideration of overstrength.

Alternative RWFD Design Method (Meeting Special Seismic Detailing Requirements, 12.10.4)

Step 10 - Determine collector forces in accordance with ASCE/SEI 7-22 Section 12.10.4.2.4. Collector forces are to be based on F_{px} forces WITHOUT the 1.5 amplification factor, multiplied by $\Omega_{0\text{-diaph}}$

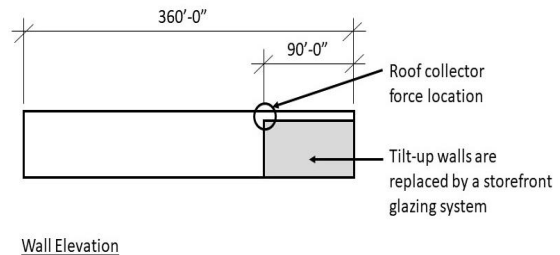

- Per ASCE/SEI 7-22 Section 12.10.4.2.4, the collector force is calculated based on the maximum transverse diaphragm shear WITHOUT amplification, multiplied by $\Omega_{0\text{-diaph}}$:
- $T/C = 1.76 \text{ klf (90 ft) (2.0)} = 317 \text{ kips}$



As with the Traditional Design Method, collector force calculation will be illustrated at the location shown in this figure. Two points are important when calculating the collector forces:

1. The collector force is determined using the diaphragm design forces WITHOUT shear amplification, and
2. Instead of using the overstrength factor Ω_0 based on the vertical system and taken from Table 12.2-1, Section 12.10.4.2.4 specifies that $\Omega_{0\text{-diaph}} = 2.0$. This value was derived from the research use to develop the Alternative RWFD provisions.

Alternative RWFD Design Method (Meeting Special Seismic Detailing Requirements, 12.10.4)

Step 11 - Check applicable ASCE/SEI 7-22 deflection and drift limitations.

- Where required by ASCE/SEI 7-22, determine $C_{d-diaph}$ and diaphragm deflections in accordance with ASCE/SEI 7-22 Section 12.10.4.2.5. All applicable ASCE/SEI 7-22 deflection and drift checks are to be completed. It is important that this includes a check that the gravity system can accommodate the mid-span deflection of the roof diaphragm, and the P-D stability of the tilt-up wall panels when subject to the diaphragm deflection.

The Step 11 check of deflection and displacement limits is the same under the Alternative RWFD Provisions as the Traditional Method.

Example One-Story RWFD Building with Steel Deck Diaphragm

Alternative RWFD Design Method (12.10.4)

NOT Meeting AISI S400 Special Seismic Detailing Requirements



FEMA

Building Seismic
Safety Council



Next, we will repeat the same Alternative RWFD Provisions design process with a steel deck diaphragm system that does NOT meet the special seismic detailing provisions.

Alternative RWFD Design Method (NOT Meeting Special Seismic Detailing Requirements, 12.10.4)

- This example building has a bare steel deck diaphragm that is welded instead of using mechanical fasteners. Because of this, the diaphragm does not meet the special seismic detailing requirements of AISI S400 Section F3.5.1.



FEMA

 Building Seismic
Safety Council



Step 1 - Check ASCE/SEI 7-22 Section 12.10.1.1 Scoping Limitations

- The following are the scoping limitations that must be checked. If the building conforms with all scoping limitations, it is eligible to use the ASCE/SEI 7-22 Section 12.10.4 procedure.
1. All portions of the diaphragm shall be designed using the provisions of this section in both orthogonal directions.
 2. The diaphragm shall consist of either a) a wood structural panel diaphragm designed in accordance with AWC SDPWS and fastened to wood framing members or wood nailers with sheathing nailing in accordance with the AWC SDPWS Section 4.2 nominal shear capacity tables, or b) a bare (untopped) steel deck diaphragm meeting the requirements of AISI S400 and AISI S310.

Once again, the design starts with a check of the Section 12.10.4 scoping provisions.

Alternative RWFD Design Method (NOT Meeting Special Seismic Detailing Requirements, 12.10.4)

3. Toppings of concrete or similar materials that affect diaphragm strength or stiffness shall not be placed over the wood structural panel or bare steel deck diaphragm.
4. The diaphragm shall not contain horizontal structural irregularities, as specified in ASCE/SEI 7-22 Table 12.3-1, except that Horizontal Structural Irregularity Type 2 (reentrant corner irregularity) is permitted.
5. The diaphragm shall be rectangular in shape or shall be divisible into rectangular segments for purpose of seismic design, with vertical elements of the seismic force-resisting system or collectors provided at each end of each rectangular segment span.

Alternative RWFD Design Method (NOT Meeting Special Seismic Detailing Requirements, 12.10.4)

6. The vertical elements of the seismic force-resisting system shall be limited to one or more of the following: concrete shear walls, precast concrete shear walls, masonry shear walls, steel concentrically braced frames, steel and concrete composite braced frames, or steel and concrete composite shear walls.
7. The vertical elements of the seismic force-resisting system shall be designed in accordance with ASCE/SEI 7-22 Section 12.8, except that they shall be permitted to be designed using the two-stage analysis procedure of ASCE/SEI 7-22 Section 12.2.3.2.2, where applicable.

As in the previous example, the structure meets all of the scoping limitations, allowing use of the Alternative RWFD Provisions.

Step 2 - Break roof diaphragm into a series of rectangular segments for purposes of design with each segment spanning to vertical elements or a collector.

- Because the example building is rectangular in plan and shear walls are located at the building perimeter, one rectangular segment extending for the full building plan will be used.

Step 3 - Determine w_{px}

- W_{px} was determined in Example Section 7.7.1 to be:
- 6,846 kips (transverse forces)
- 5,836 kips (longitudinal forces)



FEMA



Building Seismic
Safety Council



Steps 2 and 3 are the same as the previous example...

Step 4 - Determine R_{diaph}

- $R_{diaph} = 1.5$ for bare steel deck diaphragms NOT meeting the special seismic detailing requirements for AISI S400

Step 5 - Determine T_{diaph}

- $T_{diaph} = 0.001L_{diaph}$ for bare steel deck diaphragms (ASCE/SEI 7-22 Section 12.10.4.2.1)
- $T_{diaph} = 0.001 \text{ s/ft (600 ft)} = 0.60 \text{ s}$ (transverse forces)
- $T_{diaph} = 0.001 \text{ s/ft (360 ft)} = 0.36 \text{ s}$ (longitudinal forces)



FEMA



Building Seismic
Safety Council



Step 4 is distinctly different from the previous example. Because the diaphragm system does NOT meet the special seismic detailing requirements of AISI S400, R_{diaph} is required to be taken as 1.5 instead of 4.5. This will effectively triple the diaphragm design forces.

Step 5 is the same as the previous example. The diaphragm period is taken as a function of the diaphragm span and is independent of the diaphragm system.

Step 6 - Determine $C_{s-diaph}$

For transverse forces:

$$C_{s-diaph} = \frac{S_{DS}}{R_{diaph}/I_e} = \frac{1.0}{1.5/1.0} = 0.667 \quad (\text{ASCE/SEI 7-22Eq. 12.10-16a})$$

But need not exceed

$$C_{s-diaph} = \frac{S_{D1}}{T_{diaph}(R_{diaph})/I_e} = \frac{0.50}{0.60(1.5)/1.0} = 0.555 \quad (\text{ASCE/SEI 7-22 Eq. 12.10-16b})$$

- Use $C_{s-diaph} = 0.555$ transverse



FEMA



Building Seismic
Safety Council



Because R_{diaph} is taken as 1.5 instead of 4.5, the values calculated for $C_{s-diaph}$ are three times higher than the previous example. This is true for the transverse forces shown here.

Alternative RWFD Design Method (NOT Meeting Special Seismic Detailing Requirements, 12.10.4)

For longitudinal forces:

$$C_{s-diaph} = \frac{S_{DS}}{R_{diaph}/I_e} = \frac{1.0}{1.5/1.0} = 0.667 \quad (\text{ASCE/SEI 7-22 Eq. 12.10-16a})$$

- But need not exceed:

$$C_{s-diaph} = \frac{S_{D1}}{T_{diaph}(R_{diaph})/I_e} = \frac{0.50}{0.36(1.5)/1.0} = 0.926 \quad (\text{ASCE/SEI 7-22 Eq. 12.10-16b})$$

- Use $C_{s-diaph} = 0.667$ longitudinal



FEMA



Building Seismic
Safety Council



The $C_{s-diaph}$ forces are also similarly increased for the longitudinal forces shown here.

Step 7 -Determine diaphragm design force, F_{px}

- $F_{px} = C_{s-diaph} (w_{px})$ (ASCE/SEI 7-22 Eq. 12.10-15)
- $F_{px} = 0.555 (6,846) = 3,800$ kips transverse
- $F_{px} = 0.667 (5,836) = 3,893$ kips longitudinal



FEMA

Building Seismic
Safety Council



Step 7 involves calculation of the F_{px} forces, which are similarly increased by a factor of three.

Step 8 - Determine amplified shear and extent of amplified shear boundary zone

- Because the diaphragm span in both directions is greater than 100 ft., an amplified shear zone will be located at each end of the diaphragm span and extend for ten percent of the diaphragm span. The extent of the amplified shear zones are:
 - $0.10 (600 \text{ ft}) = 60 \text{ ft}$ each end for transverse forces
 - $0.10 (360 \text{ ft}) = 36 \text{ ft}$ each end for longitudinal forces.



FEMA

 Building Seismic
Safety Council



Step 8 involves the determination of the amplified shear zone. The extent of this zone remains the same as the previous example.

Step 9 - Diaphragm Design for Shear

- The diaphragm is designed for shear using F_{px} Forces. The following illustrates shear calculations for the transverse direction.
- For transverse roof diaphragm forces:
 - $w = 3,800 \text{ kips} / 600 \text{ ft} = 6.33 \text{ klf}$
 - $V = 6.33 \text{ klf} (600 \text{ ft} / 2) = 1,900 \text{ kips}$
 - $v = 1,900 \text{ kips} / 360 \text{ ft} = 5.28 \text{ klf}$ maximum at end of diaphragm span WITHOUT shear amplification
 - $v = 5.28 \text{ klf} (1.5) = 7.92 \text{ klf}$ maximum at end of diaphragm span WITH shear amplification



Step 9 involves the diaphragm design for shear. The process is the same as the previous example, but the shear forces are three times higher.

Alternative RWFD Design Method (Meeting Special Seismic Detailing Requirements, 12.10.4)

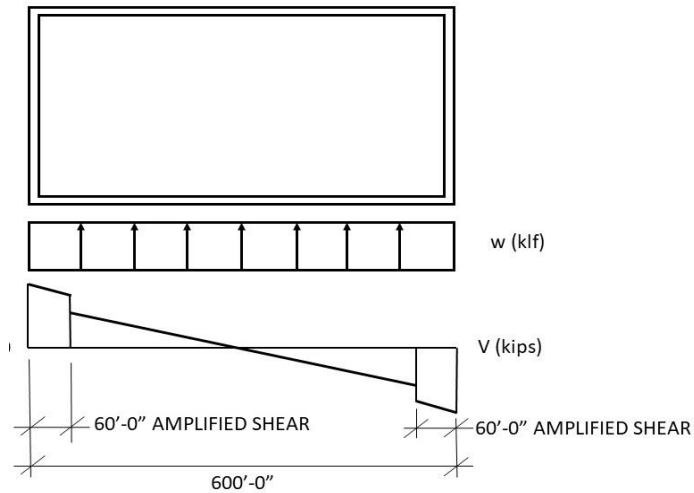

FEMA

Building Seismic
Safety Council



Matching the previous example, the resulting shear diagram for seismic forces in the transverse direction is shown in this figure. The step in shear at the amplified shear zones can be seen at either end of the span. With the shear diagram determined, the specifics of the diaphragm decking and fastening can be determined.

Step 9 - Diaphragm Design for Flexure

- For transverse roof diaphragm forces the chord force is calculated using F_{px} forces without amplification:
- $w = 3,800 \text{ kips} / 600 \text{ ft} = 6.33 \text{ klf}$
- $M = 6.33 \text{ klf} (600 \text{ ft})^2 / 8 = 284,850 \text{ kip-ft}$
- Chord $T/C = 284,850 \text{ kip-ft} / 360 \text{ ft} = 791 \text{ kips}$ maximum at diaphragm mid-span

Like the design for shear, the process of design for flexure is the same as the previous example, but the forces remain three times higher.

Alternative RWFD Design Method (NOT Meeting Special Seismic Detailing Requirements, 12.10.4)

Step 10 - Determine collector forces in accordance with ASCE/SEI 7-22 Section 12.10.4.2.4. Collector forces are to be based on F_{px} forces WITHOUT the 1.5 amplification factor, multiplied by $W_{0-diaph}$, however $W_{0-diaph}$ need not be taken as greater than R_{diaph} .

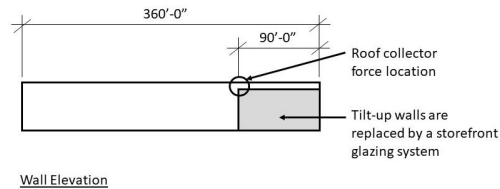

- Per ASCE/SEI 7-22 Section 12.10.4.2.4, the collector force is calculated based on the maximum transverse diaphragm shear WITHOUT amplification, multiplied by $W_{0-diaph}$, however $W_{0-diaph}$ need not be taken as greater than R_{diaph}
- $T/C = 5.28 \text{ klf (90 ft) (1.5)} = 713 \text{ kips}$



FEMA

Building Seismic
Safety Council



Again, the collector force calculation will be illustrated at the location shown in this figure.

The same two points are important when calculating the collector forces:

1. The collector force is determined using the diaphragm design forces WITHOUT shear amplification, and
2. Instead of using the overstrength factor Ω_0 based on the vertical system and taken from Table 12.2-1, Section 12.10.4.2.4 specifies that $\Omega_{0-diaph} = 2.0$. This value was derived from the research use to develop the Alternative RWFD provisions.

Step 11 - Check applicable ASCE/SEI 7-22 deflection and drift limitations.

- Where required by ASCE/SEI 7-22, determine $C_{d-diaph}$ and diaphragm deflections in accordance with ASCE/SEI 7-22 Section 12.10.4.2.5 . All applicable ASCE/SEI 7-22 deflection and drift checks are to be completed. It is important that this include a check that the gravity system can accommodate the mid-span deflection of the roof diaphragm, and the P-D stability of the tilt-up wall panels when subject to the diaphragm deflection.
- This would be good to illustrate.

The Step 11 check of deflection and displacement limits is the same under the previous example and the Traditional Method.

Example One-Story RWFD Building with Steel Deck Diaphragm

Comparison of Methods



FEMA

Building Seismic
Safety Council



140

Finally, we will take a side-by-side look at the diaphragm design forces resulting from these design examples.

Comparison of Design Methods

Table 7.7-1: Comparison of Traditional and Alternative RWFD Design Forces

Diaphragm Design Method	Special Seismic Detailing met?	Transverse			Longitudinal		
		F_{px} (kips)	v_{px} (plf)	v_{px} amplified shear zone (plf)	F_{px} (kips)	v_{px} (plf)	v_{px} amplified shear zone (plf)
Traditional ASCE/SEI 7 22 Section 12.10.1 and 12.10.2	NA	1,712	2,370	NA	1,459	1,220	NA
Alternative RWFD ASCE/SEI 7 22 Section 12.10.4	Yes	1,266	1,760	2,640	1,296	1,080	1,620
Alternative RWFD ASCE/SEI 7 22 Section 12.10.4	No	3,800	5,280	7,920	3,893	3,240	4,870



FEMA

Building Seismic Safety Council



Comparison of Traditional and Alternative RWFD Design Forces

Comparison of Design Methods

Table 7.7-2: Comparison of Traditional and Alternative RWFD Collector Forces

Diaphragm Design Method	Special Seismic Detailing met?	Chord Force T/C (kips)	Collector Force T/C (kips)
Traditional ASCE/SEI 7 22 Section 12.10.1 and 12.10.2	NA	356	533
Alternative RWFD ASCE/SEI 7 22 Section 12.10.4	Yes	264	317
Alternative RWFD ASCE/SEI 7 22 Section 12.10.4	No	791	713

1.0 kip = 4.45 kN, 1.0 ft = 0.3048 m, 1.0 ft-kip = 1.36 kN-m



FEMA

Building Seismic Safety Council



A similar pattern of increases and decreases in collector forces can be seen.

Part 2 - Closing Comments



The Alternative RWFD Provisions were developed through research that included both testing and numerical studies. The designs resulting from these provisions were demonstrated by numerical studies to provide improved seismic performance over the Traditional Design Method.

For the diaphragm illustrated in these examples, the use of the Alternative RWFD Provisions also resulted in significantly reduced diaphragm design forces in the diaphragm where AISI S400 special seismic detailing requirements were met. This reduction in diaphragm design forces should result in reduced cost of construction in addition to improved performance.

It is hoped that the improved performance and potential reduced cost will help inspire design engineers to implement the Alternative RWFD Provisions.

Questions



FEMA



Building Seismic
Safety Council



This slide is intended to initiate questions from participants.

DISCLAIMER

- NOTICE: Any opinions, findings, conclusions, or recommendations expressed in this publication do not necessarily reflect the views of the Federal Emergency Management Agency. Additionally, neither FEMA, nor any of its employees make any warranty, expressed or implied, nor assume any legal liability or responsibility for the accuracy, completeness, or usefulness of any information, product or process included in this publication.
- The opinions expressed herein regarding the requirements of the *NEHRP Recommended Seismic Provisions*, the referenced standards, and the building codes are not to be used for design purposes. Rather the user should consult the jurisdiction's building official who has the authority to render interpretation of the code.
- This training material presentation is intended to remain complete in its entirety even if used by other presenters. While the training material could be tailored for use in other presentations, we caution users to account for issues of completeness and interpretation if only part of the material is used. We also strongly suggest users give proper credit/citation to this presentation and its author.



FEMA

 Building Seismic
Safety Council



Chapter 8 Nonstructural Components: Fundamentals and Design Examples

2020 NEHRP Provisions Training Materials

Bret Lizundia, S.E., Rutherford + Chekene



FEMA



Building Seismic
Safety Council

BSSC



Learning Objectives

- Understand the parameters influencing nonstructural response
- Understand key changes coming in ASCE/SEI 7-22, including
 - The new seismic design force equation
 - How equipment support structures and platforms are handled
 - How distribution system supports are handled
- Understand how to use the *2020 NEHRP Provision Design Examples* as a resource for nonstructural component design



FEMA



Building Seismic
Safety Council



Outline of Presentation

Fundamentals

- Overview and code development process
- Parameters influencing nonstructural response
- Seismic design force equation
- Equipment support structures and platforms and distribution system supports
- Accommodation of seismic relative displacements
- Code change summary

Design Examples

- Architectural concrete wall panel
- Seismic analysis of egress stairs
- HVAC fan unit support
- Piping system seismic design
- Elevated vessel seismic design

Note: Images without references are taken from FEMA P-2192-V1. Full references for partial citations are given in FEMA P-2192-V1.



FEMA



Building Seismic
Safety Council



Fundamentals

Nonstructural Components

Nonstructural Components

- Defined as “a part of an architectural, mechanical, or electrical system within or without a building or nonbuilding structure” (ASCE/SEI 7-22 Section 11.2)
- These items make up the majority of the replacement value of most buildings.
- Design based on two fundamentally different demands:
 - Resistance to inertial forces (seismic forces)
 - Accommodation of imposed displacements



Suspended Acoustic Tile Ceilings
Restrained by Compression Struts and
Diagonal Splayed Wires
(from FEMA E-74, 2012, *Reducing the
Risks of Nonstructural Earthquake
Damage—A Practical Guide*)



FEMA

 Building Seismic
Safety Council



Relative Costs

The largest capital investment in most commercial buildings is in the nonstructural systems and contents.

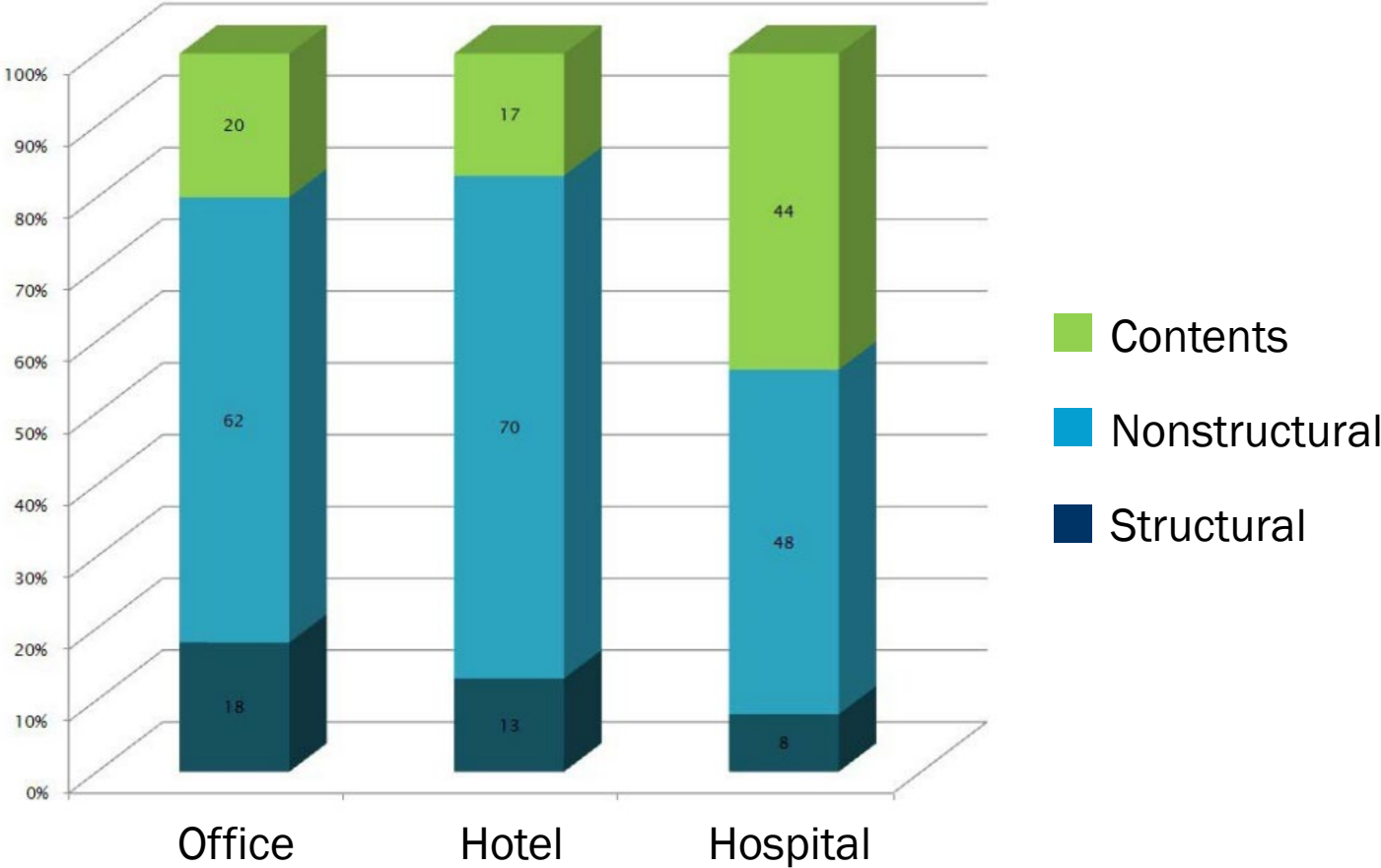

Image from FEMA E-74 (2012) and Whittaker, A.S. and Soong, T.T. (2003). "An overview of nonstructural component research at three U.S. earthquake engineering research centers," in *Proceedings of Seminar on Seismic Design, Performance, and Retrofit of Nonstructural Components in Critical Facilities*, Applied Technology Council, ATC-29-2, pp. 271-280, Redwood City, California.

Typical investments in building construction



FEMA

Building Seismic Safety Council



Anticipated Behavior of Noncritical Nonstructural Components

From ASCE/SEI 7-22 Sections C13.1 and C13.1.3

Minor Earthquake

- Minimal damage, not likely to affect functionality

Moderate Earthquake

- Some damage that might affect functionality

Design Earthquake

- Major damage but significant falling hazards are avoided; likely loss of functionality

MCE_R Earthquake

- No implicit performance goals



FEMA

 Building Seismic Safety Council



ASCE/SEI 7-22 Chapter 13: Seismic Design Requirements for Nonstructural Components

Section 13.1

- Information on applicability of nonstructural design provisions

Section 13.2

- Importance of the component or system
- Adequacy of component for seismic forces and certification requirements

Section 13.3

- Acceleration and displacement demands for nonstructural components

Section 13.4

- Design considerations for attachments of nonstructural components to the structure

Section 13.5

- Design considerations for architectural components

Section 13.6

- Design considerations for mechanical and electrical components



FEMA

 Building Seismic
Safety Council



Code Development Process for Recent Revisions to Nonstructural Provisions

- General Research (through 2018)
- ATC-120 Phase 2 (2016-2018) / NIST GCR 18-914-43 (2018)
 - Synthesize past research
 - Project research and analyses
 - Recommended equation
- BSSC PUC (2018-2020)
 - Issue Team 5 develops code proposal
 - Main PUC reviews, makes recommendations, ballots proposal
 - BSSC member orgs. ballot proposal
 - 2020 *NEHRP Provisions* published
- ASCE 7 Code Committee (2020-2021)
 - Nonstructural Issue Team refines proposal
 - ASCE 7 Seismic Subcommittee ballots proposal
 - Main committee ballots proposal
 - Public comment
 - Final approval for ASCE/SEI 7-22
 - ASCE/SEI 7-22 published



FEMA

 Building Seismic Safety Council



Key Terminology

- PCA: Peak Component Acceleration
- PFA: Peak Floor Acceleration
- PGA: Peak Ground Acceleration

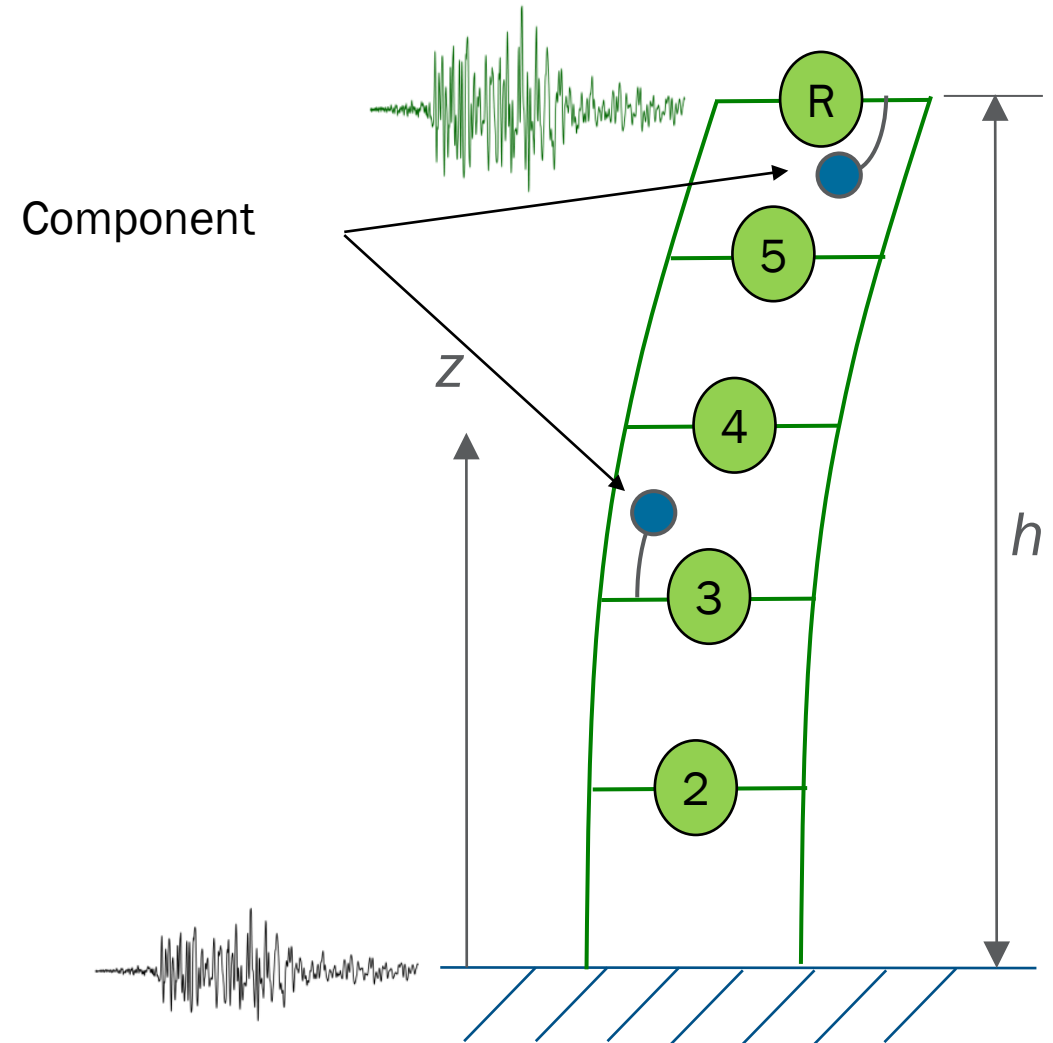

Parameters Influencing Nonstructural Response

- Ground shaking intensity, PGA
- Building
 - Seismic force-resisting system
 - Building modal period, $T_{n,bldg}$
 - Building ductility, μ_{bldg}
 - Building damping, β_{bldg}
 - Building configuration (such as plan and vertical irregularities)
 - Floor diaphragm rigidity
- Height of component within the building, z/h
- Component
 - Component period, T_{comp}
 - Component and/or anchorage ductility, μ_{comp}
 - Component damping, β_{comp}
 - Component reserve strength margin, $R_{po,comp}$



FEMA

 Building Seismic Safety Council



Seismic Force-Resisting System

$$T_{comp} = 0.5 \text{ sec}$$

Reinforced Concrete SW

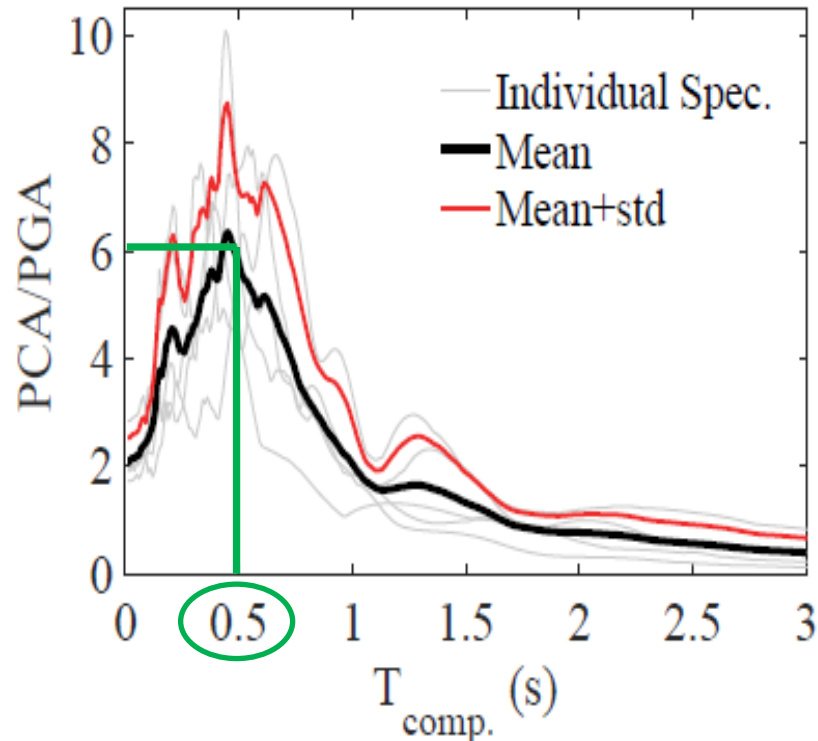

Steel SMRF

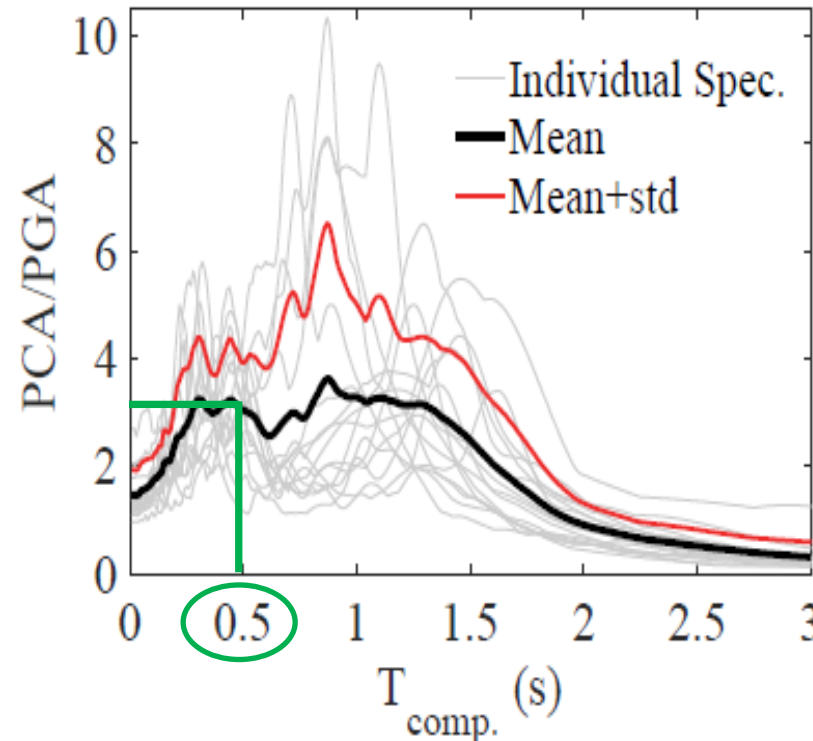

Effect of building stiffness on PCA/PGA for instrumental recordings
(from NIST GCR 18-917-43, 2018 and
Lizundia paper in 2019 SEAOC Convention Proceedings)

Key Takeaway

- Same component responds very differently in different seismic force-resisting systems

Figure Assumptions

- Elastic component assumed with $\beta_{comp} = 5\%$
- Dataset includes 19 recordings with $PGA > 0.15g$



FEMA

Building Seismic Safety Council



Building Modal Periods, $T_{n,bldg}$

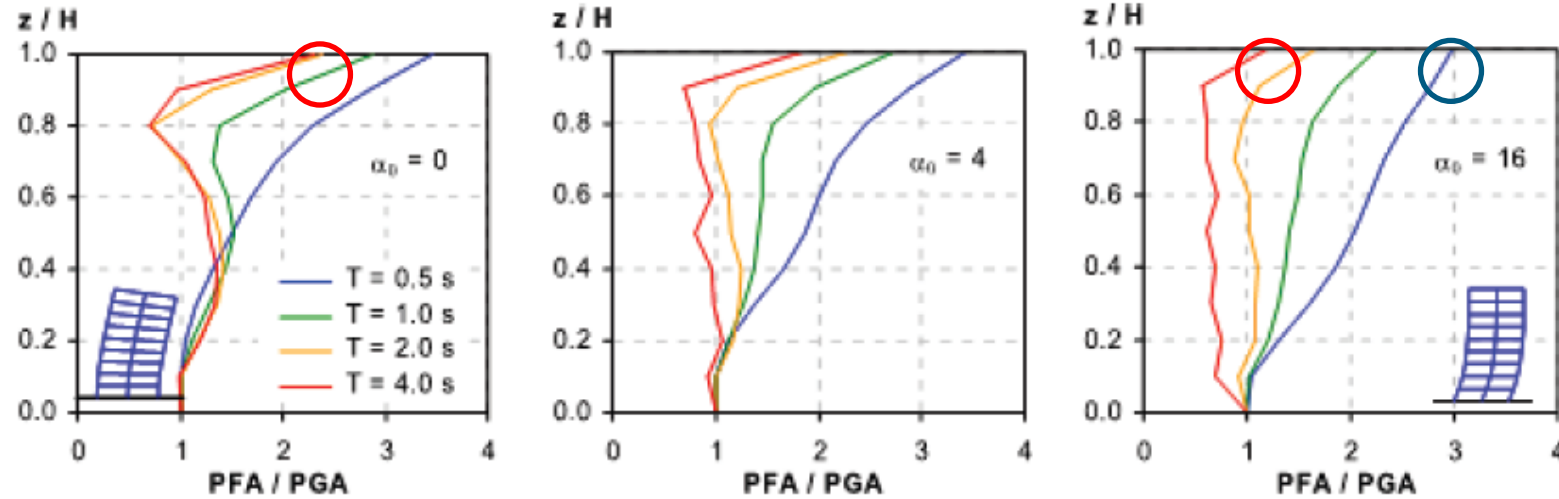

Effect of period of vibration and lateral system stiffness on PFA/PGA

Key Takeaway

- Longer period means less amplification
- Cantilever systems have more “whipping” action

α_0 = Lateral stiffness ratio, defined as $\alpha_0 = H/(GA/EI)^{0.5}$

H = height,

GA = shear rigidity of a shear beam

EI = the flexural stiffness

$\alpha_0 = 0$ represents a pure flexural model

α_0 approaching infinity represents a pure shear beam

(from Miranda and Taghavi, 2009)



FEMA

Building Seismic
Safety Council



Component Period, T_{comp} , and Building Period Resonance

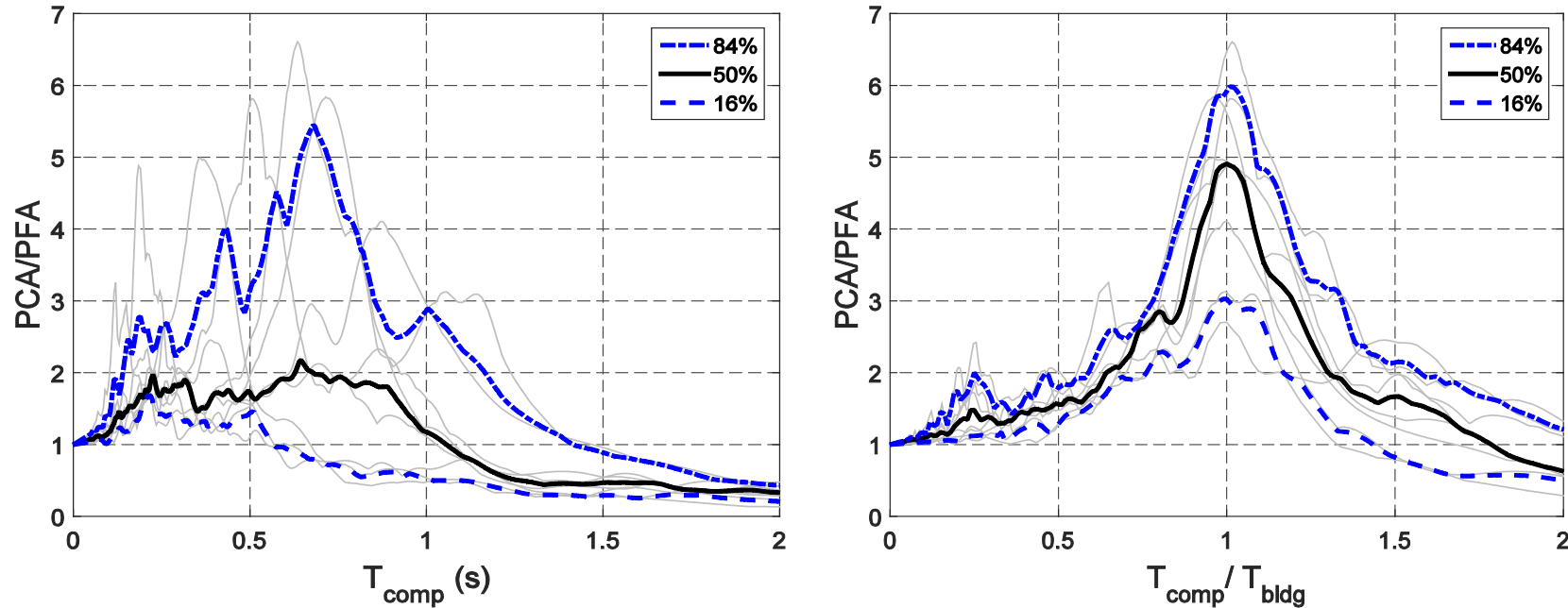

Relationship between PCA/PFA comparing spectra without normalization (left) and with normalization (right) by T_{bldg} (from Kazantzi et al., 2019)

Key Takeaway

- Normalized x-axis is helpful to understand influence of building in component response

Figure Assumptions

- Elastic component with $\beta_{comp} = 5\%$
- Dataset includes eight recordings with $PCA > 0.9g$



FEMA

Building Seismic Safety Council



Sources of Component and/or Anchorage Ductility

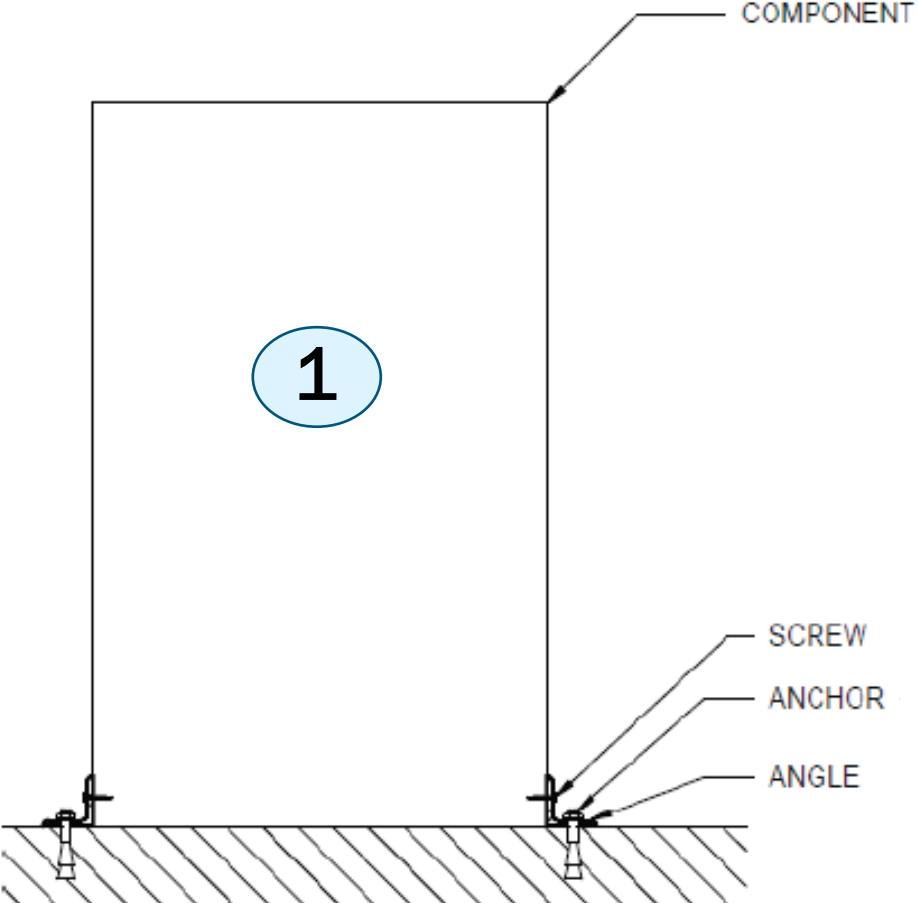

- 1. Component
- 2. Connection of component to anchor
- 3. Anchor

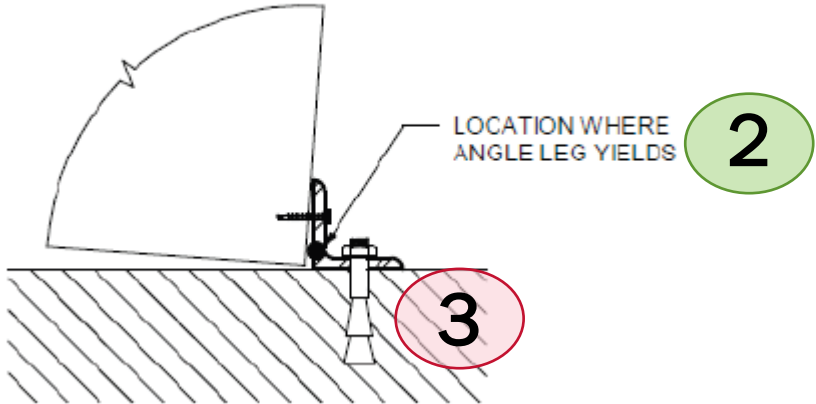

Component/Anchorage Ductility, μ_{comp}

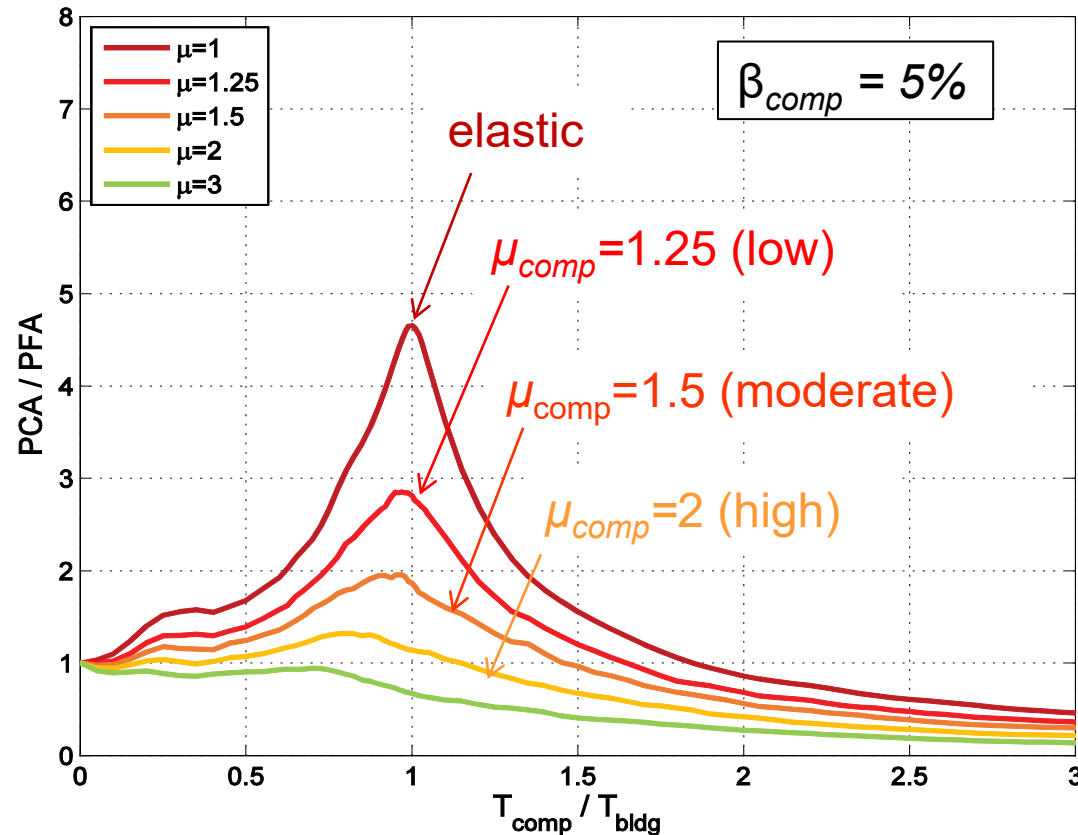

Mean response of PCA/PFA versus T_{comp}/T_{bldg} for different levels of component ductility (from NIST, 2018 and Lizundia, 2019)

Key Takeaway

- Ductility substantially reduces component response, particularly at resonance

Figure Assumptions

- Elastic component assumed with $\beta_{comp} = 5\%$
- Dataset includes 86 recordings with $PCA > 0.9g$



FEMA

Building Seismic Safety Council



ATC-120 Proposed Seismic Design Force Equation

$$\frac{F_p}{W_p} = \text{PGA} \times \left[\frac{\left(\frac{\text{PFA}}{\text{PGA}}\right)}{R_{\mu bldg}} \right] \times \left[\frac{\left(\frac{\text{PCA}}{\text{PFA}}\right)}{R_{po,bldg}} \right] \times I_p$$

Reduction factor for building ductility

Reduction factor for component reserve strength

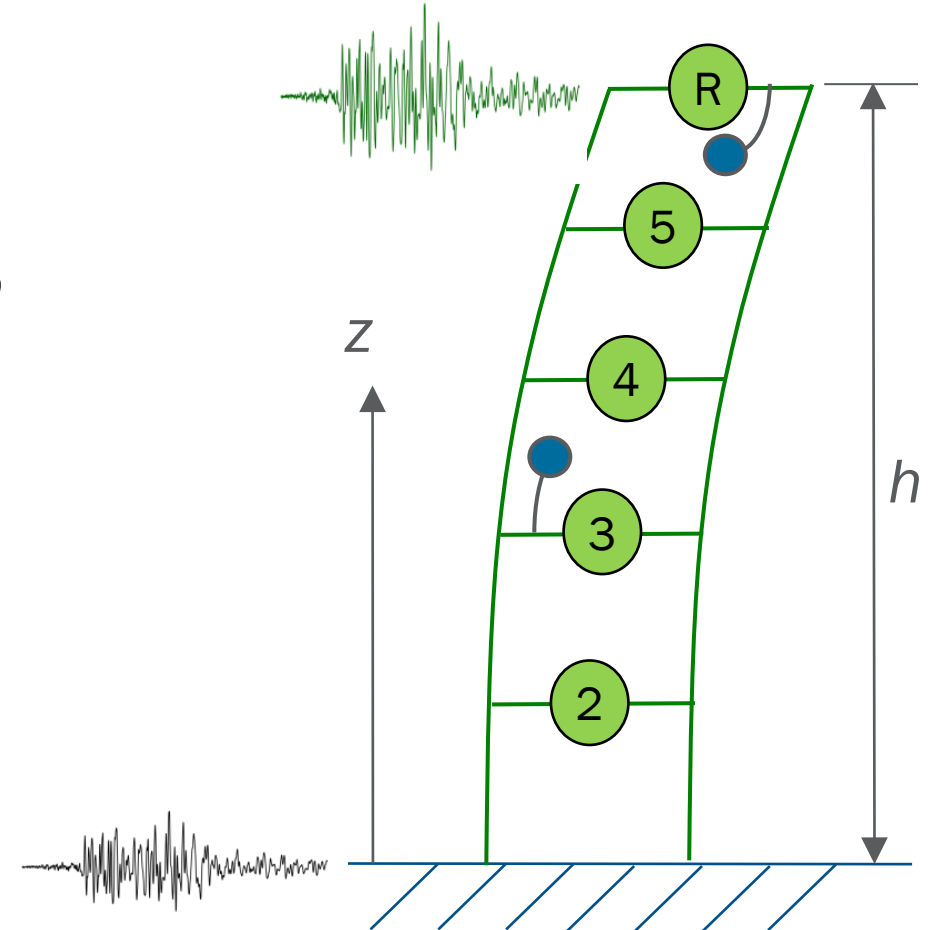

Evolution of Seismic Design Force Equation

ASCE 7-16

$$\frac{F_p}{W_p} = (0.4S_{DS}) \times \left[1 + 2 \left(\frac{z}{h} \right) \right] \times \left[\frac{a_p}{R_p} \right] \times I_p$$

 Ground response

 PFA/PGA

NIST GCR 18-917-43 (ATC-120)

$$\frac{F_p}{W_p} = \text{PGA} \times \left[\frac{\left(\frac{\text{PFA}}{\text{PGA}} \right)}{R_{\mu\text{bldg}}} \right] \times \left[\frac{\left(\frac{\text{PCA}}{\text{PFA}} \right)}{R_{po,\text{bldg}}} \right] \times I_p$$

 Resonance and component ductility

 Component strength reserve margin

2020 NEHRP Provisions and ASCE 7-22

$$\frac{F_p}{W_p} = (0.4S_{DS}) \times \left[\frac{H_f}{R_{\mu}} \right] \times \left[\frac{C_{AR}}{R_{po}} \right] \times I_p$$

 Building ductility



FEMA



Building Seismic
Safety Council



PFA/PGA (H_f) Amplification Factor

$$H_f = 1 + a_1 \left(\frac{z}{h}\right) + a_2 \left(\frac{z}{h}\right)^{10}$$

or:

$$H_f = 1 + 2.5 \left(\frac{z}{h}\right)$$

where:

$$a_1 = \frac{1}{T_a} \leq 2.5$$

$$a_2 = [1 - (0.4/T_a)^2] \geq 0$$

$$T_a = C_t h_n^x$$

$$\frac{F_p}{W_p} = (0.4S_{DS}) \times \left[\frac{H_f}{R_\mu}\right] \times \left[\frac{C_{AR}}{R_{po}}\right] \times I_p$$

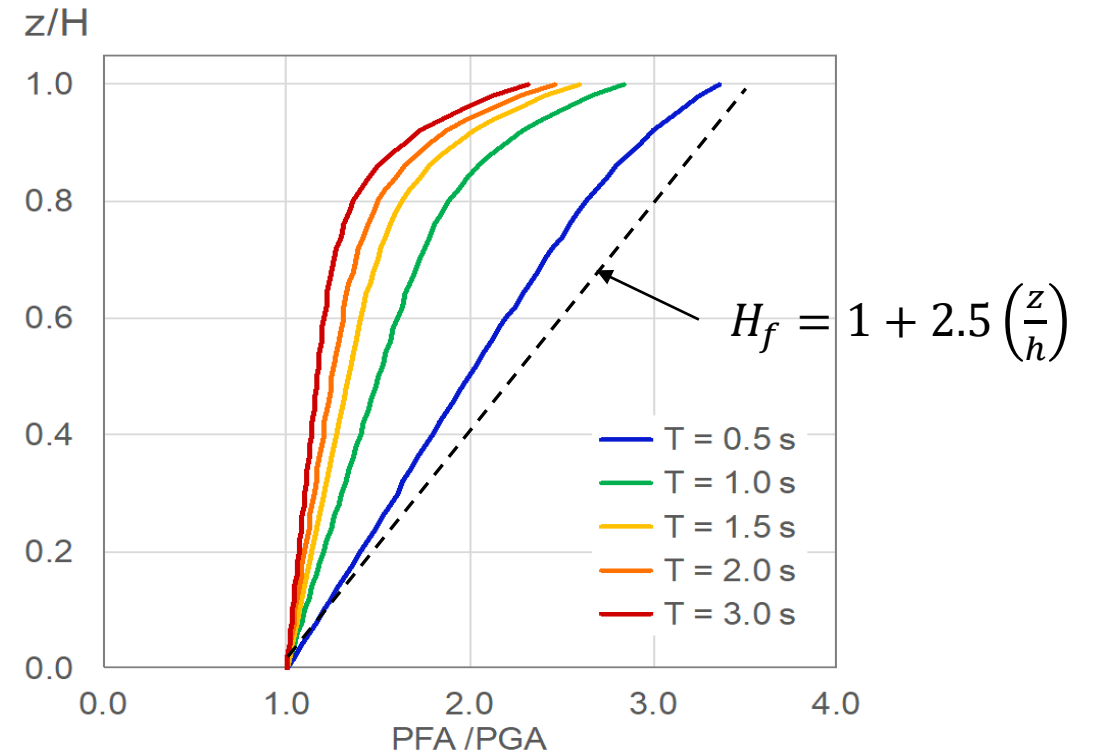

Building Ductility, R_μ

$$R_\mu = (1.1 R / (I_e \Omega_0))^{1/2} \geq 1.3$$

$$\frac{F_p}{W_p} = (0.4 S_{DS}) \times \left[\frac{H_f}{R_\mu} \right] \times \left[\frac{C_{AR}}{R_{po}} \right] \times I_p$$

where:

R = Response modification factor for the building or nonbuilding structure

I_e = Importance Factor for the building or nonbuilding structure

Ω_0 = Overstrength factor for the building or nonbuilding structure

For components at or below grade, R_μ shall be taken as 1.0.



FEMA

 Building Seismic Safety Council



PCA/PFA (C_{AR})

Component Ductility				
Location of Component	Resonance	Category	Assumed Ductility	$\left(\frac{PCA}{PFA}\right)$
Ground	More Likely	Elastic	$\mu_{comp}=1$	2.5
		Low	$\mu_{comp}=1.25$	2.0
		Moderate	$\mu_{comp}=1.5$	1.8
		High	$\mu_{comp}\geq 2$	1.4
	Less Likely	Any	-	1.0
Roof or Elevated Floor	More Likely	Elastic	$\mu_{comp}=1$	4.0
		Low	$\mu_{comp}=1.25$	2.8
		Moderate	$\mu_{comp}=1.5$	2.2
		High	$\mu_{comp}\geq 2$	1.4
	Less Likely	Any	-	1.0

$$\frac{F_p}{W_p} = (0.4S_{DS}) \times \left[\frac{H_f}{R_\mu}\right] \times \left[\frac{C_{AR}}{R_{po}}\right] \times I_p$$



Unlikely vs. Likely to be in Resonance

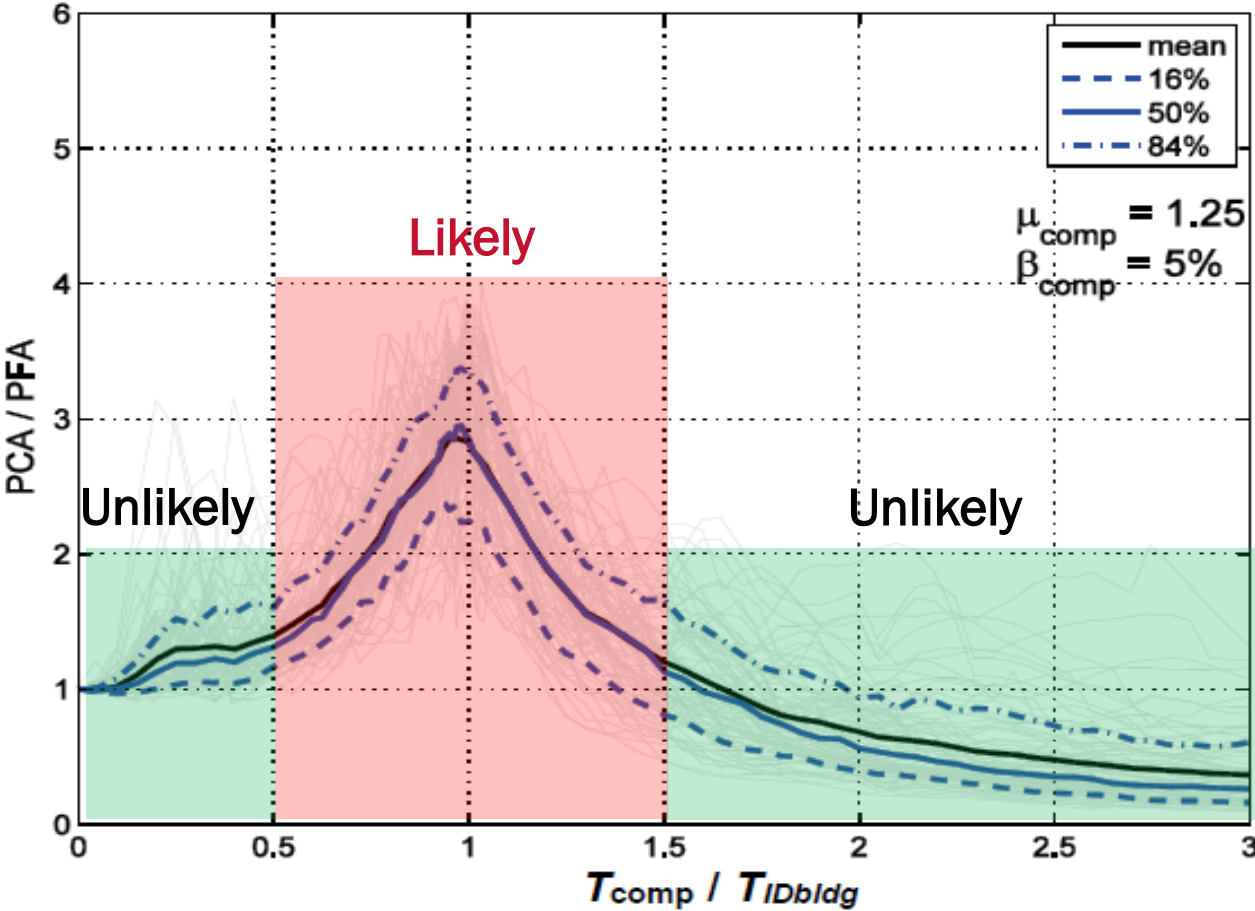

Unlikely to be in resonance:

- $T_{comp} / T_{bldg} < 0.5$
- $T_{comp} / T_{bldg} > 1.5$
- $T_{comp} \leq 0.06$



Component Resonance Ductility Factor, C_{AR} , and Component Strength, R_{po}

- Architectural components shall be assigned a factor per ASCE/SEI 7-22 Table 13.5-1
- Mechanical and electrical equipment shall be assigned a factor per ASCE/SEI 7-22 Table 13.6-1

$$\frac{F_p}{W_p} = (0.4S_{DS}) \times \left[\frac{H_f}{R_\mu} \right] \times \left[\frac{C_{AR}}{R_{po}} \right] \times I_p$$



Alternative Procedure for Nonlinear Response History Analysis

$$\frac{F_p}{W_p} = 0.4S_{DS} \times a_i \times \left[\frac{C_{AR}}{R_{po}} \right] \times I_p$$

where:

a_i = Maximum acceleration at Level i obtained from nonlinear response history analysis at the design earthquake ground motion.

- a_i replaces the ratio $\frac{H_f}{R_\mu}$ in main seismic design force equation
- The nonlinear analysis can account for the following parameters:
 - H_f , variation of acceleration up the height of the structure specific to its dynamic properties
 - R_μ , reduction of PFA due to the structure's ductility



FEMA

Building Seismic
Safety Council



Equipment Support Structures and Platforms and Distribution System Supports

Three different types of supports:

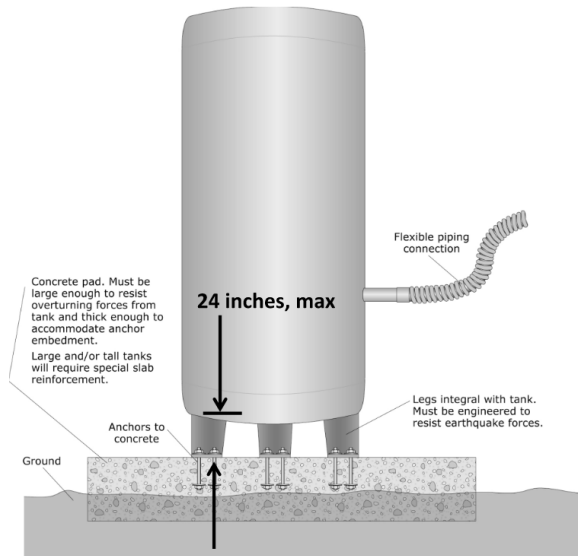

Nonstructural component with integral equipment supports

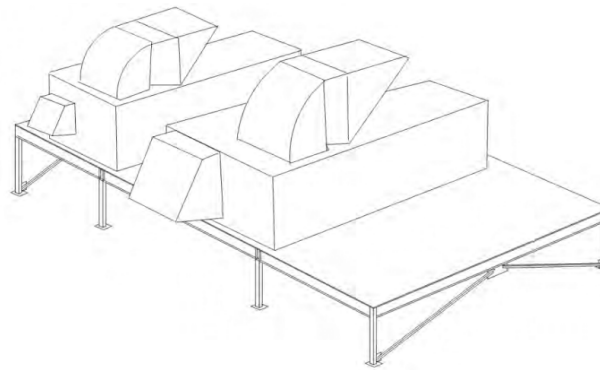

Equipment support platform supporting two mechanical components

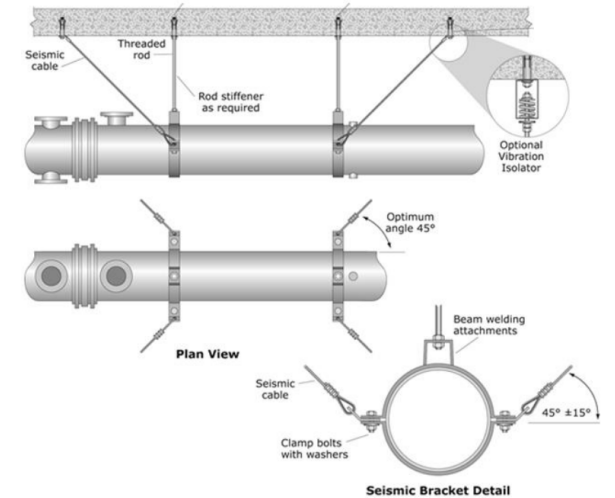

Distribution system support for piping

Images from FEMA P-2082-1 (2020) and FEMA E-74 (2012)



FEMA

Building Seismic Safety Council



Accommodation of Seismic Relative Displacements

$$D_{pI} = D_p I_e$$

- Displacement **within** Structure A between Level x and Level y

$$D_p = \delta_{xA} - \delta_{yA}$$

but not greater than:

$$D_p = \frac{(h_x - h_y)\Delta_{aA}}{h_{sx}}$$

- Displacement **between** Structures A and B between Level x and Level y

$$D_p = |\delta_{xA}| + |\delta_{yB}|$$

but not greater than:

$$D_p = \frac{h_x \Delta_{aA}}{h_{sx}} + \frac{h_y \Delta_{aB}}{h_{sx}}$$



Development of Nonstructural Seismic Design Force Equations

- The revisions for the nonstructural seismic design force equations in ASCE/SEI 7-22 are based on the following publications:
 - NIST GCR 18-917-43: *Recommendations for Improved Seismic Performance of Nonstructural Components (2018)*, produced by the Applied Technology Council ATC-120 project
 - 2020 *NEHRP Recommended Seismic Provisions for New Buildings and Other Structures*, used to develop code proposals for ASCE/SEI 7-22

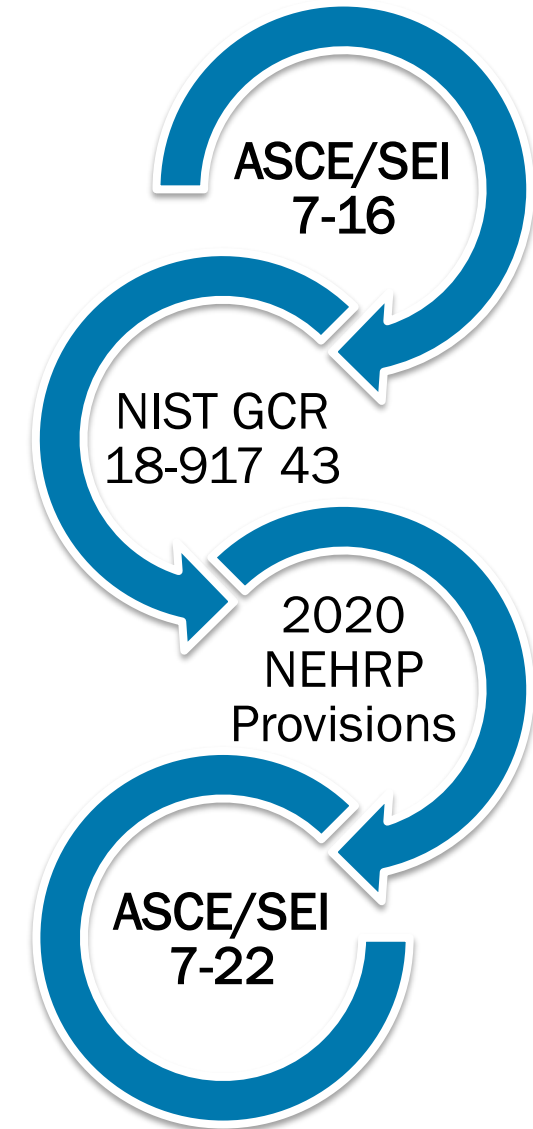

FEMA

Building Seismic
Safety Council



Proposed Equations in NIST GCR 18-917-43

- Key features in the proposed equations:
 - Refinement to relate PFA to PGA at different heights in the building and incorporate the building period, T
 - Inclusion of building ductility. Increased building ductility generally reduces nonstructural component response.
 - Refinement of relationship between PCA and PFA to account for resonance due to ratio of component period-to-building period and component ductility



ATC-120 Phase 2 (2016-2018/
NIST GCR 18-917-43 (2018)



FEMA

Building Seismic
Safety Council



Proposed Equations in NIST GCR 18-917-43

- Key features in the proposed equations (continued):
 - Differentiation between ground-supported and superstructure-supported components for amplification factors
 - Inclusion of components and attachments inherent overstrength, R_{po}
 - Revision to architectural component categories in ASCE/SEI 7-16 Table 13.5
 - Distinction addressing different parameters for the component and the equipment support structure



ATC-120 Phase 2 (2016-2018/
NIST GCR 18-917-43 (2018))



FEMA

Building Seismic
Safety Council



Revisions in the 2020 *NEHRP Provisions*

- The NIST GCR 18-917-43 recommendations were used to develop code proposals for the 2020 *NEHRP Provisions*, which include the following key issues:
 - Terminology revision: $PGA \rightarrow 0.4S_{DS}$, $PFA/PGA \rightarrow H_f$, $PCA/PFA \rightarrow C_{AR}$, $R_{\mu bldg} \rightarrow R_{\mu}$, $R_{pocomp} \rightarrow R_{po}$
 - R_{μ} clarification, $R_{\mu}=1.0$ for ground supported components
 - Assignment of C_{AR} , R_{po} , and Ω_{op} values for different components based on ductility and likelihood of resonance
 - Separation of elevators and escalators in Table 13.6-1 into two different categories



NEHRP Recommended Seismic Provisions for New Buildings and Other Structures

Volume I: Part 1 Provisions, Part 2 Commentary
FEMA P-2082-1 / September 2020



2020 *NEHRP Provisions*



FEMA

Building Seismic
Safety Council



Revisions in the 2020 *NEHRP Provisions*

- The NIST GCR 18-917-43 recommendations were used to develop code proposals for the 2020 *NEHRP Provisions*, which include the following key issues:
 - R_{po} refinement for reasonable value for most components
 - Maximum (cap) value consensus of $1.6S_{DS}I_pW_p$ to be compatible with analytical results
 - Overstrength factor in concrete and masonry, Ω_{op} compatible with the F_p equation
 - Addition of detailed provisions for different types of supports
 - Clarification and improved requirements for seismic design of penthouses and rooftop structures



NEHRP Recommended Seismic Provisions for New Buildings and Other Structures

Volume I: Part 1 Provisions, Part 2 Commentary
FEMA P-2082-1 / September 2020



2020 *NEHRP Provisions*



FEMA

Building Seismic
Safety Council



Revisions for ASCE/SEI 7-22

- The 2020 *NEHRP Provisions* were used to develop code proposals for ASCE/SEI 7-22, which include the following key issues:
 - Seismic Importance Factor, I_e , added to the denominator of the R_μ equation
 - Revision to specify direction of loading using F_p
 - Increase of Ω_{op} values for selected architectural components in Table 13.5-1 and mechanical and electrical components in Table 13.6-1
 - Increase of R_{op} values for selected piping systems and duct systems for mechanical and electrical components in Table 13.6-1



FEMA

 Building Seismic Safety Council



Significant Changes from ASCE/SEI 7-16 to ASCE/SEI 7-22

- Definition of equipment supports (Section 11.2)
- Detailed scope of design criteria for nonstructural components (Section 13.1)
- Explicit load combinations for nonstructural components (Section 13.2.2)
- Required analysis for condition where the nonstructural component weight is equal to or greater than 20% the combined effective seismic weight, W (Section 13.2.9)
- Updated horizontal seismic design forces, F_p (Section 13.3.1)
 - Equation and coefficients are more rigorously based in instrumental records and analytical findings and better account for key parameters that affect response.
- Seismic design force provision using nonlinear response history analysis is updated; other dynamic analysis methods are removed (Section 13.3.1.5).



FEMA

 Building Seismic Safety Council



Significant Changes from ASCE/SEI 7-16 to ASCE/SEI 7-22 (cont.)

- Ω_{op} is required to increase the load effects for anchors in concrete or masonry, instead of Ω_0 (Section 13.4.2).
- Architectural component list is expanded, and items account for updated coefficient for seismic design: C_{AR} , R_{po} , and Ω_{op} (Table 13.5-1).
Example: Partitions split into short light frame, tall light frame, reinforced masonry and other
- Penthouse and rooftop structure requirements are added (Section 13.5.11).
- Mechanical and electrical component list is expanded, and items account for updated coefficient for seismic design: C_{AR} , R_{po} , and Ω_{op} (Table 13.6-1).
- Equipment support structures and platforms are required to be designed (Section 13.6.4.6).
- Distribution system supports are required to be designed (Section 13.6.4.7).



FEMA

 Building Seismic Safety Council



Minor Changes from ASCE/SEI 7-16 to ASCE/SEI 7-22

- Seismic Design Category applicability is extended (Section 13.1.2).
- Component Importance Factor, I_p (Section 13.1.3)
- Nonstructural components exempt from seismic requirements are summarized in a table (Section 13.1.4).
- Most of general design requirements remain the same, with the exceptions noted previously (Section 13.2).
- Specific requirements for architectural components are mostly unchanged (Section 13.5).
- Except for the support conditions, specific requirements for mechanical and electrical components are mostly unchanged (Section 13.6).



FEMA

 Building Seismic
Safety Council



Unchanged in ASCE/SEI 7-22 (same as ASCE/SEI 7-16)

- Horizontal seismic forces maximum and minimum values remain the same (Section 13.3.1).

$$\frac{F_p}{W_p} \leq 1.6S_{DS}I_p \quad (\text{Equation 13.3-2})$$

$$\frac{F_p}{W_p} \geq 0.3S_{DS}I_p \quad (\text{Equation 13.3-3})$$

- Seismic relative displacements equations are unchanged (Section 13.3.2).
- Component fundamental period is determined with the same equation (Section 13.3.3).



FEMA

 Building Seismic Safety Council



Questions?



FEMA



Building Seismic
Safety Council



Design Examples

Nonstructural Components

Design Examples for Architectural Components

- Architectural concrete wall panel
 - Providing gravity support and accommodating story drift in cladding
 - Spandrel panel
 - Column cover
 - Prescribed seismic displacements
- Seismic analysis of egress stairs
 - Prescribed seismic forces
 - Prescribed seismic displacements
- HVAC fan unit support
 - Case 1: Direct attachment to structure
 - Case 2: Support on vibration isolation springs
- Piping system seismic design
 - Piping system design
 - Pipe supports and bracing
 - Prescribed seismic displacements
- Elevated vessel seismic design
 - Vessel support and attachments
 - Supporting frame



FEMA

 Building Seismic Safety Council



Architectural Concrete Wall Panel

- Providing gravity support and accommodating story drift in cladding
- Spandrel panel
- Column cover
- Prescribed seismic displacements

*Public domain image from
piqsels.com*



FEMA



Building Seismic
Safety Council



Architectural Concrete Wall Panel Description

Example Summary

- **Nonstructural component:** Architectural – exterior nonstructural wall elements and connections
- **Building seismic force-resisting system:** Steel special moment frames
- **Equipment support:** Not applicable
- **Occupancy:** Office
- **Risk Category:** II
- **Component Importance Factor:** $I_p = 1.0$
- **Number of stories:** 5
- $S_{DS} = 1.487$

- Architectural components are a 4.5-inch-thick NWC spandrel panel and column cover
- Spandrel panel supports glass windows weighing 10 psf
- The girders at Level 3 support the spandrel panel under consideration.
- The column cover under consideration is between Level 3 and Level 4.



FEMA

 Building Seismic Safety Council



Architectural Concrete Wall Panel Description

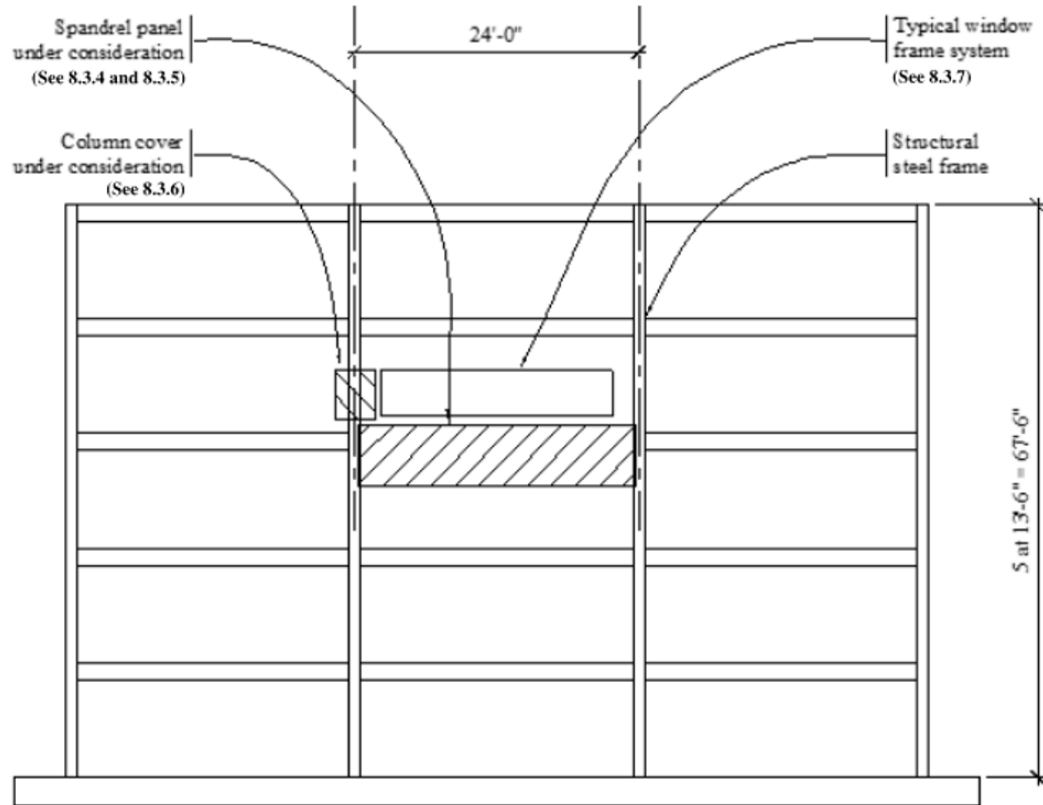

Five-story building showing panels location

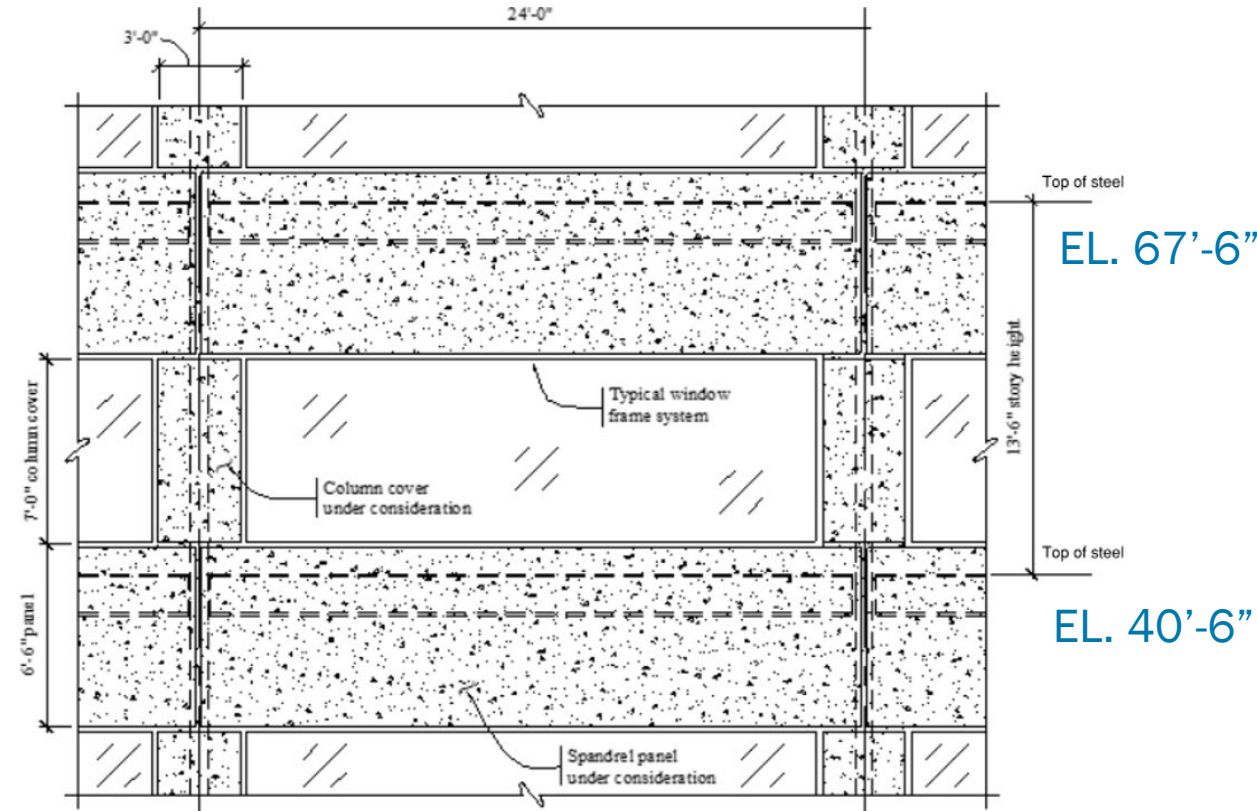

Detailed building elevation



FEMA

Building Seismic Safety Council



Providing Gravity Support and Accommodating Story Drift in Cladding

- Understanding the cladding system components is the first step for the concrete precast panel seismic design.
- Two crucial items should be determined:
 - Gravity support approach for the precast panel components
 - Mechanism to accommodate story drift
- Approaches to accommodate interstory drift
 - Rocking
 - Sliding

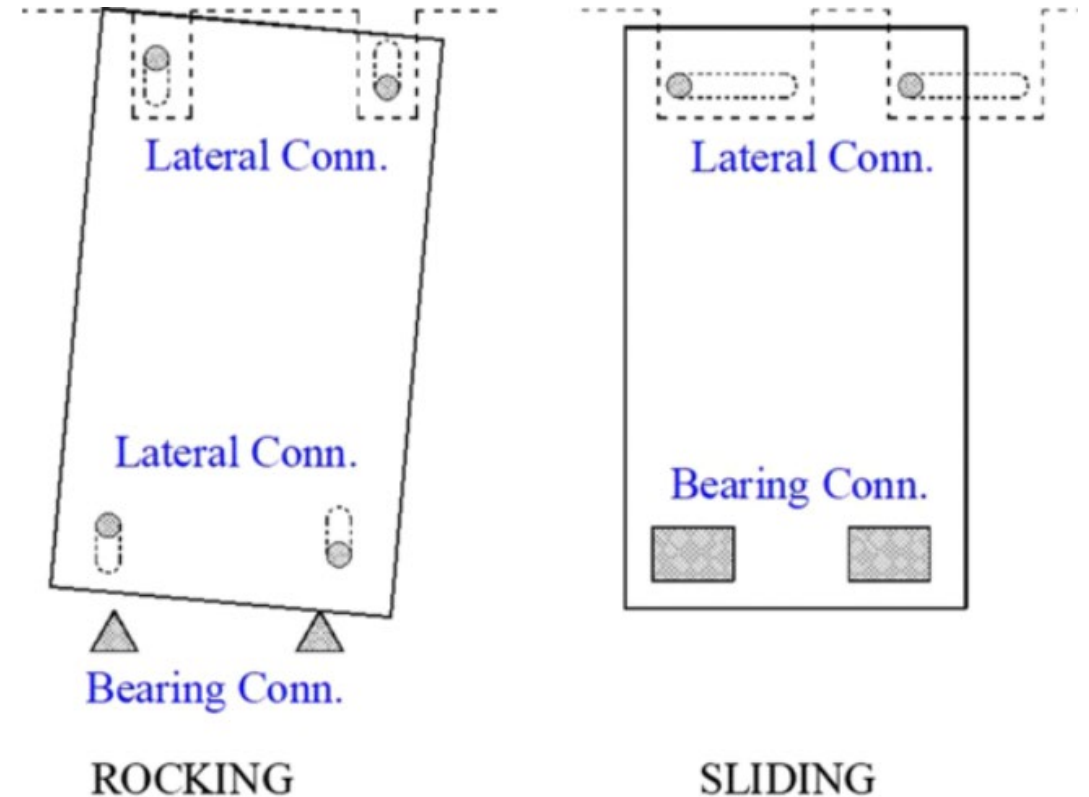

Rocking and sliding mechanisms in panels

Rocking Cladding Connection System

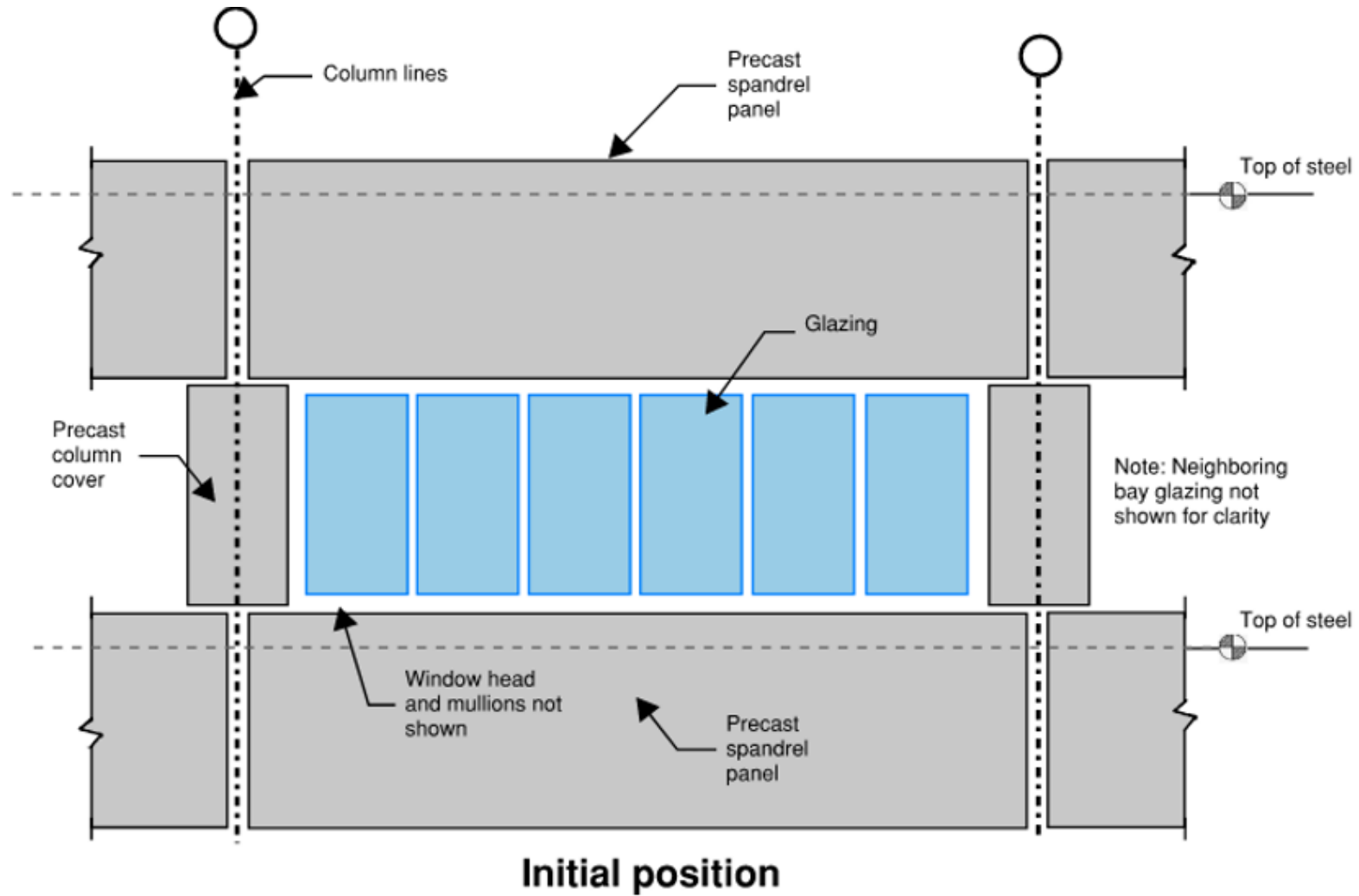

Rocking Cladding Connection System

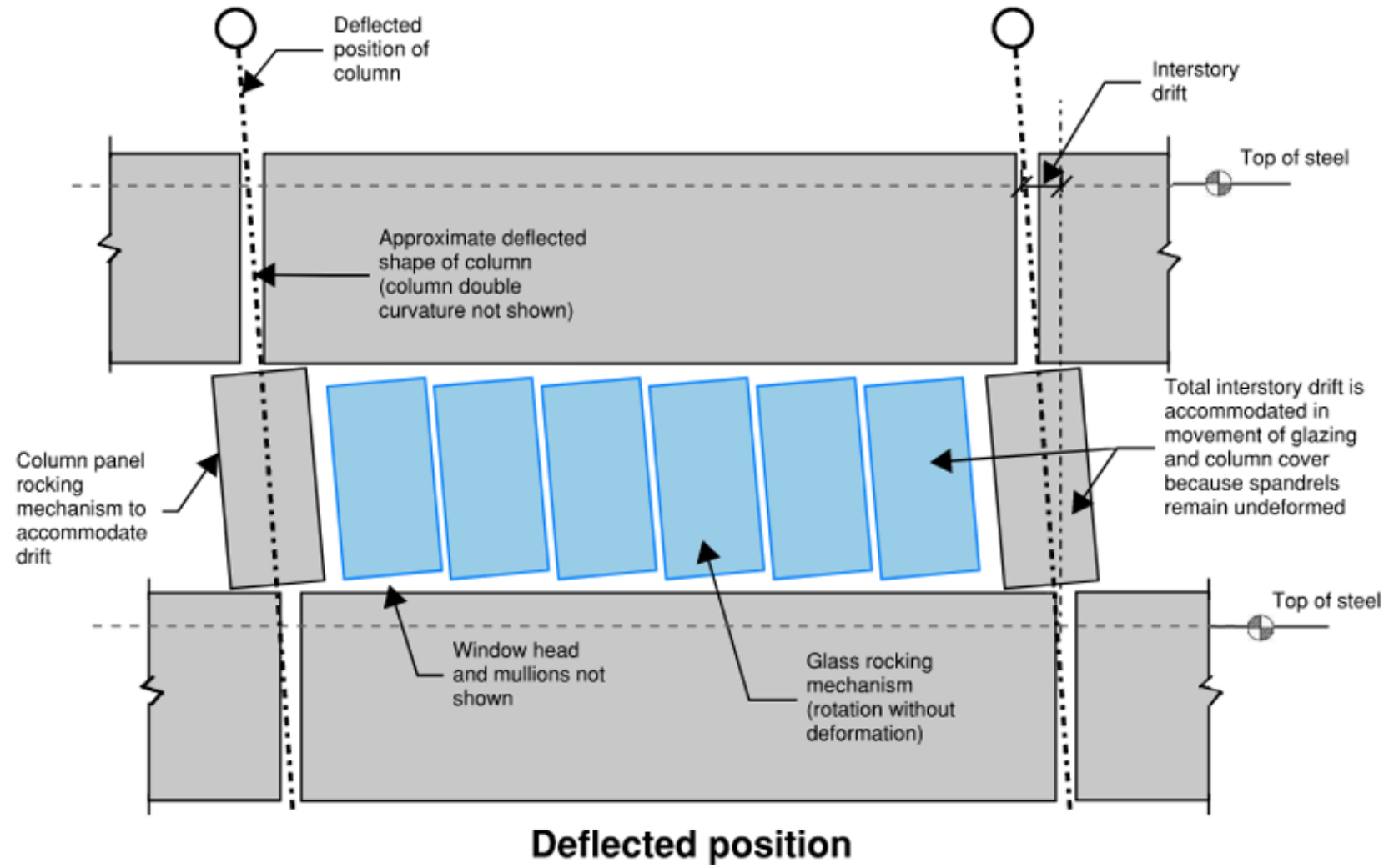

Window Framing System Racking Mechanism

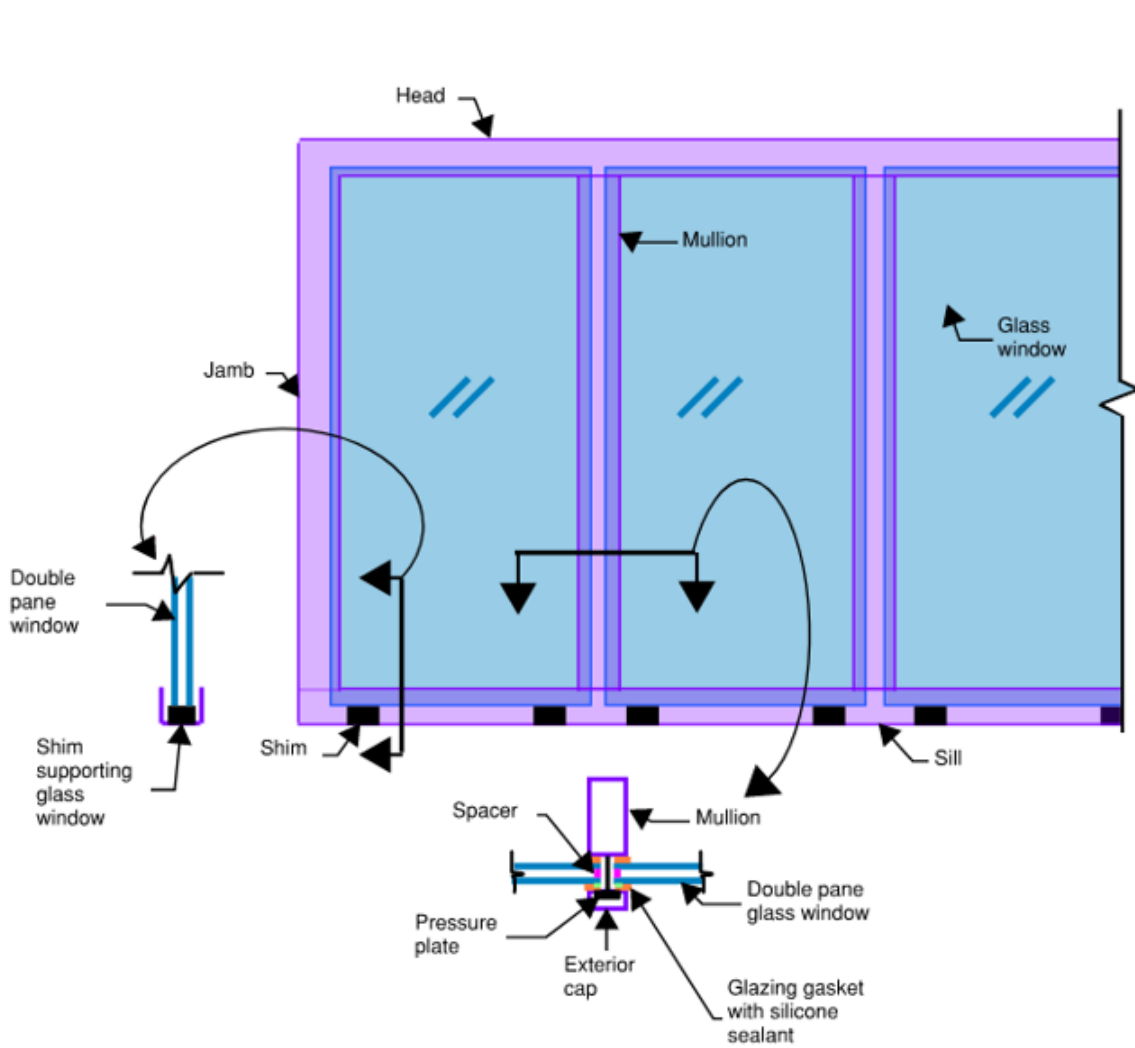

Initial position

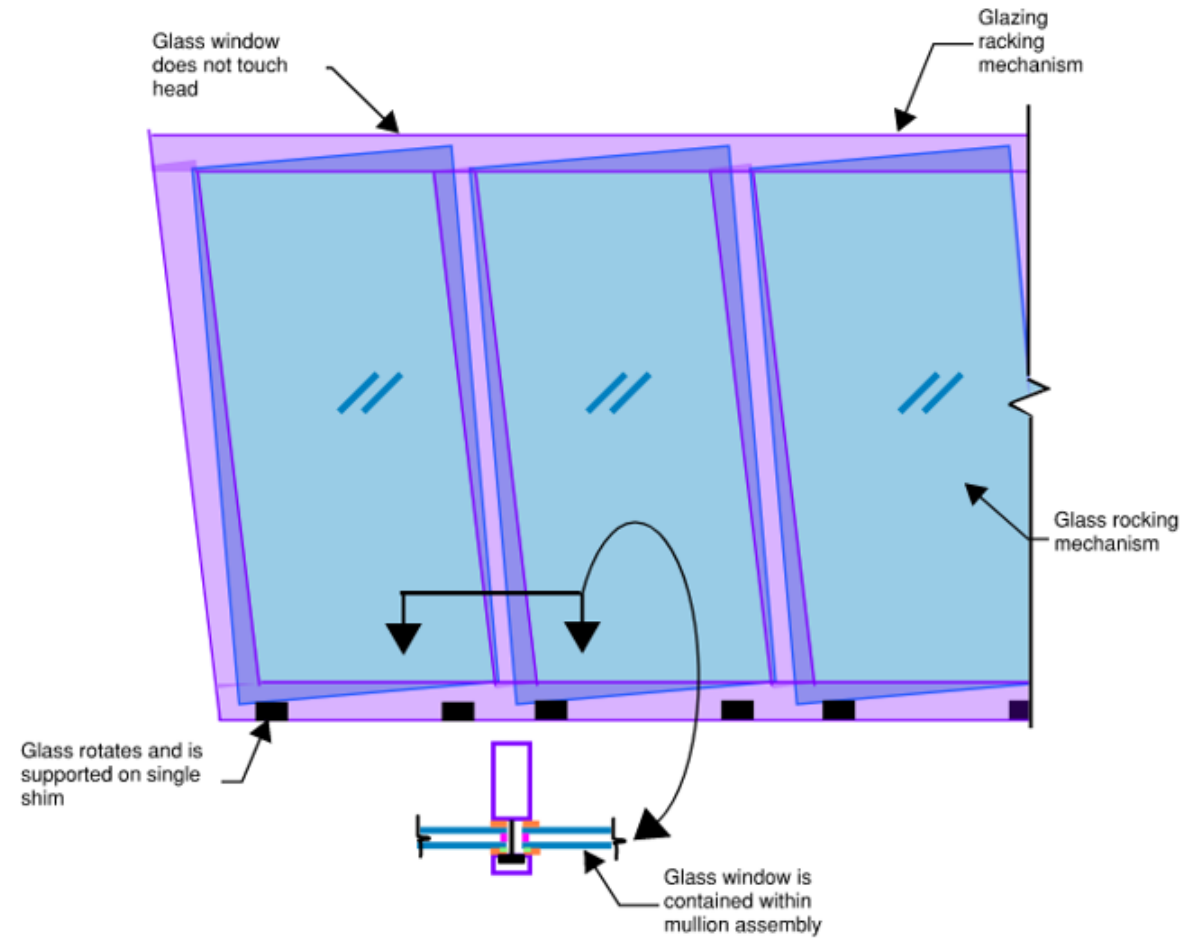

Deflected position



ASCE/SEI 7-22 Parameters and Coefficients

Coefficients for Architectural Components (Table 13.5-1)

- Exterior nonstructural wall elements and connections – wall element, and body of wall panel connections:
 - $C_{AR} = 1.0$
 - $R_{po} = 1.5$
 - $\Omega_{0p} = 2.0$
- Exterior nonstructural wall elements and connections – fasteners of the connecting system:
 - $C_{AR} = 2.8$
 - $R_{po} = 1.5$
 - $\Omega_{0p} = 1.0$



FEMA

 Building Seismic Safety Council



ASCE/SEI 7-22 Parameters and Coefficients

- Design coefficients and factors for seismic force-resisting system (Table 12.2-1)
 - Steel SMRF: $R = 8.0$ and $\Omega_0 = 3.0$
- Short period design spectral acceleration, $S_{DS} = 1.487$
- Seismic Importance Factor, $I_e = 1.0$
- Component Importance Factor, $I_p = 1.0$
- Redundancy factor, $\rho = 1.0$
- Height of attachment at Level 3, $z = 40.5$ ft
- Average roof height, $h = 67.5$ ft
- Story height, $h_{sx} = 13.5$ ft



ASCE/SEI 7-22 Parameters and Coefficients

- Spandrel panel weight

$$W_p = (150 \text{ lb/ft}^3)(24 \text{ ft long})(6.5 \text{ ft high})(4.5 \text{ in. thick}/12 \text{ ft/in.}) = 8,775 \text{ lb}$$

- Glass weight,

$$W_p = (10 \text{ lb/ft}^2)(21 \text{ ft long})(7 \text{ ft high}) = 1,470 \text{ lb}$$

- Column cover weight,

$$W_p = (150 \text{ lb/ft}^3)(3 \text{ ft wide})(7 \text{ ft high})(4.5 \text{ in. thick}/12 \text{ ft/in.}) = 1,181 \text{ lb}$$

- Approximate fundamental period of the supporting structure, T_a (Section 12.8.2.1)

$$\text{Steel SMRF: } T_a = C_t h_n^x = (0.028)(67.5 \text{ ft})^{0.8} = 0.81 \text{ s}$$



ASCE/SEI 7-22 Parameters and Coefficients

- Force amplification factor as a function of height in the structure, H_f

$$a_1 = \frac{1}{T_a} = \frac{1}{0.81 \text{ s}} = 1.23 \leq 2.5$$

$$a_2 = [1 - (0.4/T_a)^2] = [1 - (0.4/0.81 \text{ s})^2] = 0.76 \geq 0$$

$$H_f = 1 + a_1 \left(\frac{z}{h}\right) + a_2 \left(\frac{z}{h}\right)^{10} = 1 + 1.23 \left(\frac{40.5 \text{ ft}}{67.5 \text{ ft}}\right) + 0.76 \left(\frac{40.5 \text{ ft}}{67.5 \text{ ft}}\right)^{10} = 1.74$$

Compare H_f value using alternative equation that does not require T_a :

$$H_f = 1 + 2.5 \left(\frac{z}{h}\right) = 1 + 2.5 \left(\frac{40.5 \text{ ft}}{67.5 \text{ ft}}\right) = 2.50 \quad (44\% \text{ increase})$$

- Structure ductility reduction factor, R_μ

$$R_\mu = (1.1 R / (I_e \Omega_0))^{1/2} = (1.1(8 / ((1)(3)))^{1/2} = 1.71 \geq 1.3$$



Applicable Requirements

- Component failure shall not cause failure of an essential architectural, mechanical, or electrical component (Section 13.2.4).
- Seismic attachments shall be bolted, welded, or otherwise positively fastened without considering the frictional resistance produced by the effects of gravity (Section 13.4).
- F_p shall be applied at the component's center of gravity and distributed relative to the component's mass distribution (Section 13.3.1).
- Effects of seismic relative displacements shall be considered in combination with displacements caused by other loads as appropriate (Section 13.3.2).
- Exterior nonstructural wall panels or elements that are attached to or enclose the structure shall be designed to accommodate the seismic relative displacements, and movements caused by temperature changes (Section 13.5.3).



FEMA

 Building Seismic
Safety Council



Spandrel Panel Layout

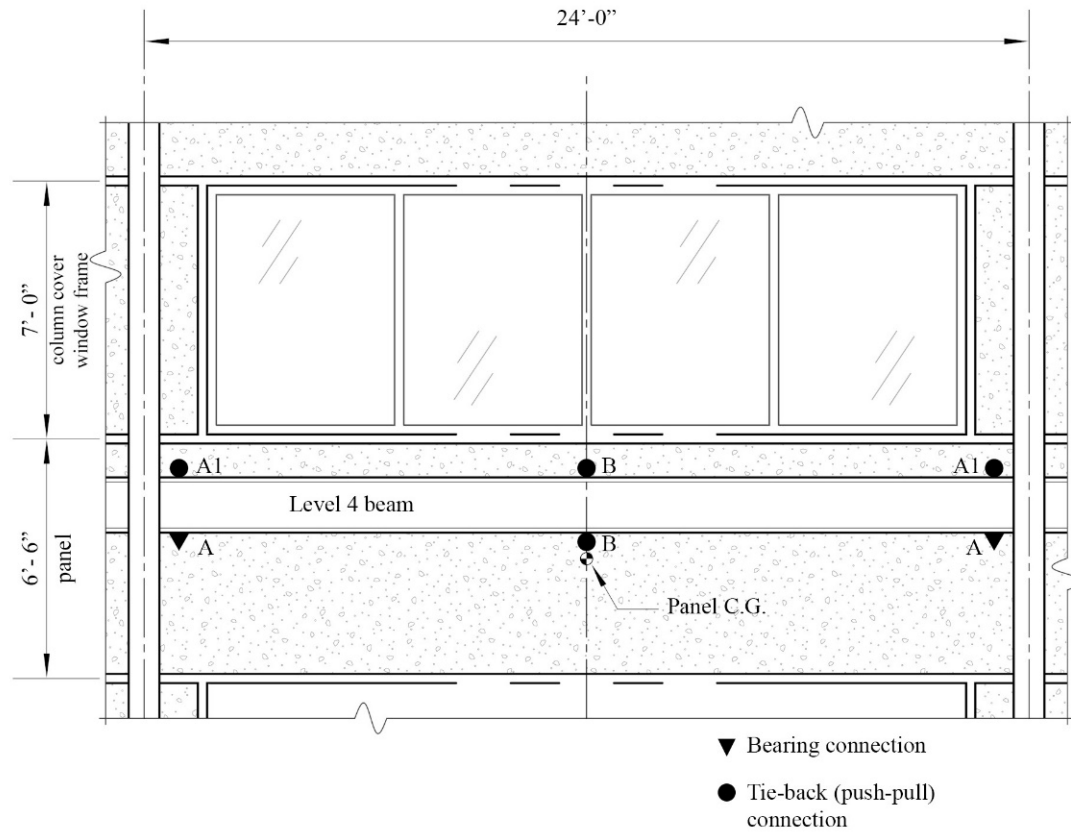

Spandrel panel layout connection from interior

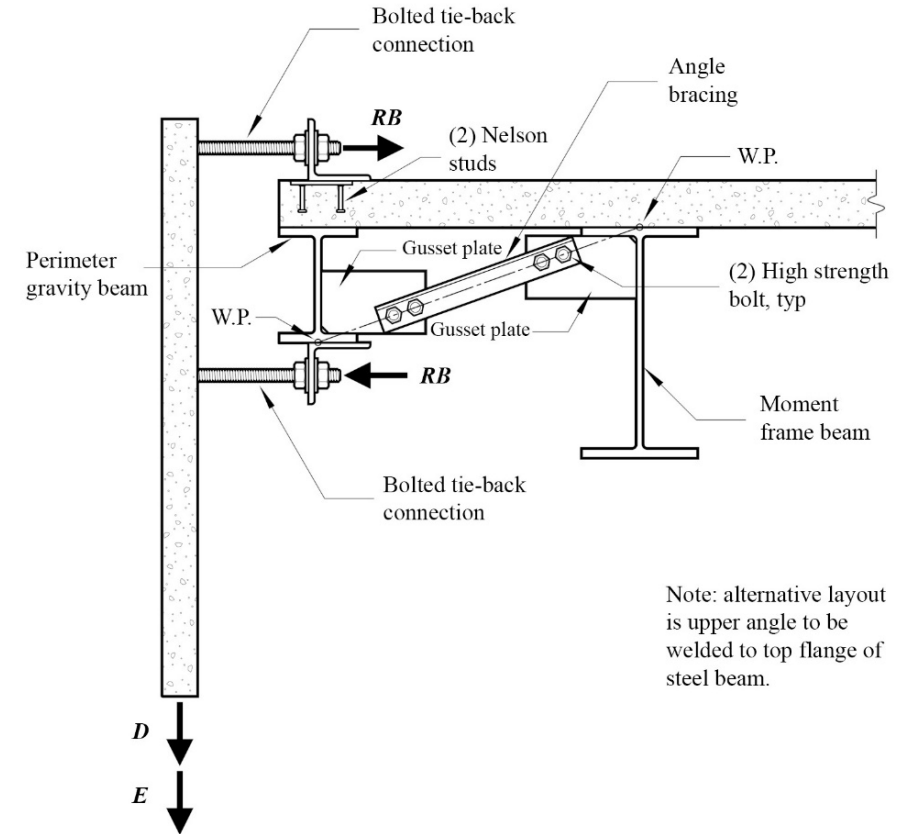

Spandrel panel section at midspan

Prescribed Seismic Forces: Wall Element and Body of Wall Panel Connections

- Spandrel panel and glass weight, $W_p = D = 8,775 \text{ lb} + 1,470 \text{ lb} = 10,245 \text{ lb}$
- Seismic design force, F_p

$$F_p = 0.4S_{DS}I_pW_p \left[\frac{H_f}{R_\mu} \right] \left[\frac{C_{AR}}{R_{po}} \right] = 0.4(1.487)(1.0)(W_p) \left[\frac{1.74}{1.71} \right] \left[\frac{1.0}{1.5} \right] = 0.403W_p$$

$$F_{p,max} = 1.6S_{DS}I_pW_p = 1.6(1.487)(1.0)(W_p) = 2.379W_p$$

$$F_{p,min} = 0.3S_{DS}I_pW_p = 0.3(1.487)(1.0)(W_p) = 0.446W_p \quad (\text{controlling equation})$$

$$F_p = 0.446W_p = 0.446(10,245 \text{ lb}) = 4,570 \text{ lb} \quad (\text{controlling seismic design force})$$



Prescribed Seismic Forces: Wall Element and Body of Wall Panel Connections

- Horizontal seismic load effect, E_h

$$Q_E = F_p = 4,570 \text{ lb}$$

$$E_h = \rho Q_E = (1.0)(4,570 \text{ lb}) = 4,570 \text{ lb}$$

- Vertical seismic load effect, E_v

$$E_v = 0.2S_{DS}D = (0.2)(1.487g)(10,245 \text{ lb}) = 3,047 \text{ lb}$$

- Basic Load Combinations for Strength Design to determine the design member and connection forces to be used in conjunction with seismic and gravity loads:

$$1.2D + E_v + E_h + L + 0.2S \quad (\text{Load Combination 6})$$

$$0.9D - E_v + E_h \quad (\text{Load Combination 7})$$

For nonstructural components, the terms L and S are typically zero.



Proportioning and Design: Wall Element and Body of Wall Panel Connections

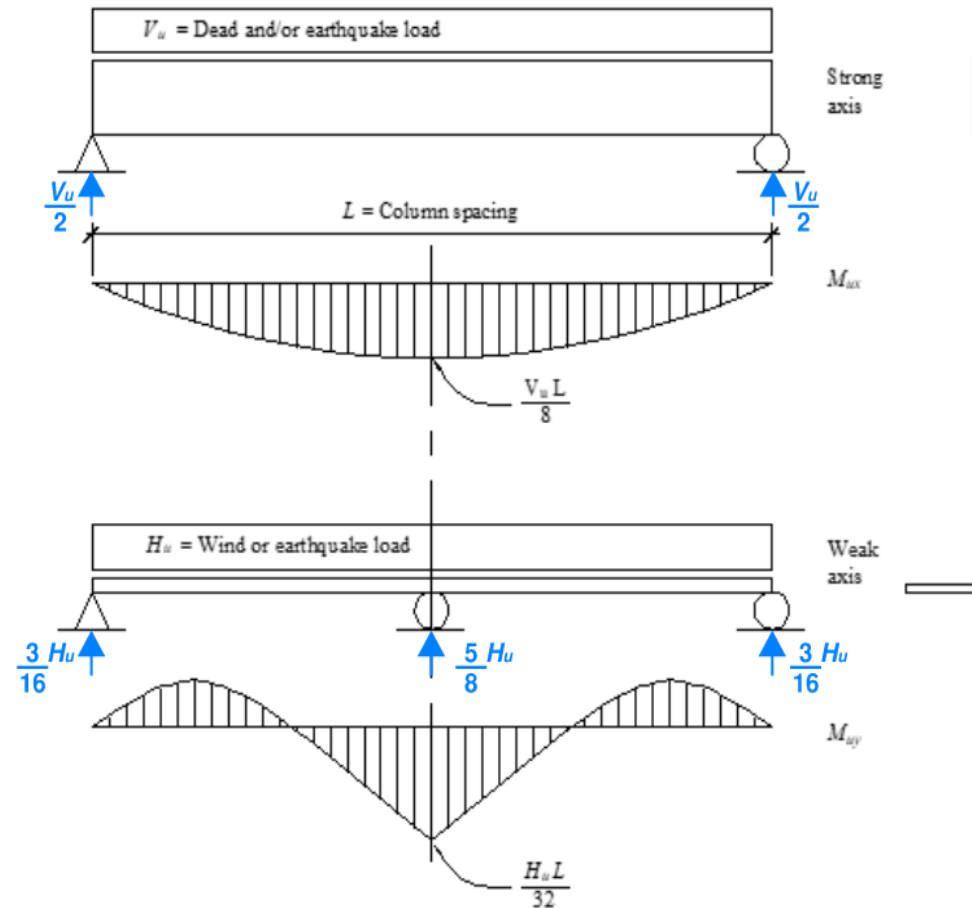

Spandrel panel bending moments

- The vertical forces, V_u , horizontal forces, H_u , and moments, M_u , are calculated using the applicable strength load combinations

Proportioning and Design: Wall Element and Body of Wall Panel Connections

- Basic Load Combination 1: $1.4D$

$$V_u = 1.4D = 1.4(10,245 \text{ lb}) = 14,343 \text{ lb} \quad (\text{vertical downward force})$$

$$M_{ux} = \frac{V_u L}{8} = \frac{(14,343 \text{ lb})(24 \text{ ft})}{8} = 43,029 \text{ lb-ft} \quad (\text{strong axis bending moment})$$

- Basic Load Combination 6: $1.2D + E_v + E_h + L + 0.2S$

$$V_{u,max} = 1.2D + E_v = 1.2(10,245 \text{ lb}) + 3,047 \text{ lb} = 15,341 \text{ lb} \quad (\text{vertical downward force})$$

$$\parallel H_u = E_h = 4,570 \text{ lb} \quad (\text{hor. load parallel to panel})$$

$$\perp H_u = E_h = 4,570 \text{ lb} \quad (\text{hor. load perpendicular to panel})$$

$$M_{ux,max} = \frac{V_{u,max} L}{8} = \frac{(15,341 \text{ lb})(24 \text{ ft})}{8} = 46,023 \text{ lb-ft} \quad (\text{strong axis bending moment})$$

$$M_{uy} = \frac{H_u L}{32} = \frac{(4,570 \text{ lb})(24 \text{ ft})}{32} = 3,428 \text{ lb-ft} \quad (\text{weak axis bending moment})$$



Proportioning and Design: Wall Element and Body of Wall Panel Connections

- Basic Load Combination 7: $0.9D - E_v + E_h$

$$V_{u,min} = 0.9D - E_v = 0.9(10,245 \text{ lb}) - 3,047 \text{ lb} = 6,174 \text{ lb} \quad (\text{vertical downward force})$$

$$\parallel H_u = E_h = 4,570 \text{ lb} \quad (\text{horizontal load parallel to panel})$$

$$\perp H_u = E_h = 4,570 \text{ lb} \quad (\text{horizontal load perp. to panel})$$

$$M_{ux,min} = \frac{V_{u,min}L}{8} = \frac{(6,174 \text{ lb})(24 \text{ ft})}{8} = 18,521 \text{ lb-ft} \quad (\text{strong axis bending moment})$$

$$M_{uy} = \frac{H_u L}{32} = \frac{(4,570 \text{ lb})(24 \text{ ft})}{32} = 3,428 \text{ lb-ft} \quad (\text{weak axis bending moment})$$



Prescribed Seismic Forces: Fasteners of the Connecting System

- The “fasteners of the connecting system” category is intended to apply to the connections with limited ductility that can have a brittle failure mechanism.
- Spandrel panel and glass weight, $W_p = D = 8,775 \text{ lb} + 1,470 \text{ lb} = 10,245 \text{ lb}$
- Seismic design force, F_p

$$F_p = 0.4S_{DS}I_pW_p \left[\frac{H_f}{R_\mu} \right] \left[\frac{C_{AR}}{R_{po}} \right] = 0.4(1.487)(1.0)(W_p) \left[\frac{1.74}{1.71} \right] \left[\frac{2.8}{1.5} \right] = 1.129W_p \quad (\text{controlling equation})$$

$$F_{p,max} = 1.6S_{DS}I_pW_p = 1.6(1.487)(1.0)(W_p) = 2.379W_p$$

$$F_{p,min} = 0.3S_{DS}I_pW_p = 0.3(1.487)(1.0)(W_p) = 0.446W_p$$

$$F_p = 1.1291W_p = 1.129(10,245 \text{ lb}) = 11,568 \text{ lb} \quad (\text{controlling seismic design force})$$

For this example, F_p almost triples when compared to the spandrel panel wall element calculations.



Prescribed Seismic Forces: Fasteners of the Connecting System

- Horizontal seismic load effect, E_h

$$Q_E = F_p = 11,568 \text{ lb}$$

$$E_h = \rho Q_E = (1.0)(11,568 \text{ lb}) = 11,568 \text{ lb}$$

- Vertical seismic load effect, E_v

$$E_v = 0.2S_{DS}D = (0.2)(1.487g)(10,245 \text{ lb}) = 3,047 \text{ lb}$$

- Basic Load Combinations for Strength Design to determine the design member and connection forces to be used in conjunction with seismic and gravity loads:

$$1.2D + E_v + E_h + L + 0.2S \quad (\text{Load Combination 6})$$

$$0.9D - E_v + E_h \quad (\text{Load Combination 7})$$

For nonstructural components, the terms L and S are typically zero.



Proportioning and Design: Fasteners of the Connecting System

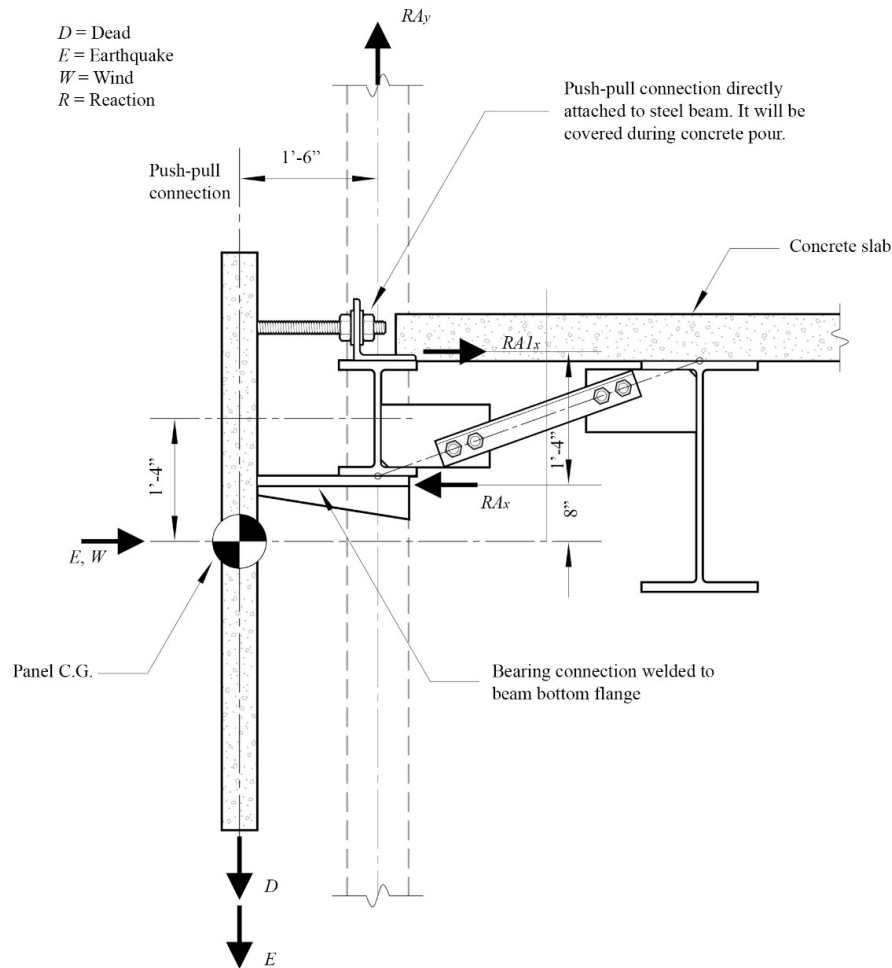

Spandrel panel connection and design forces

- Proportioning and design is determined in a similar manner as the “wall element and body of wall panel connections”
- Refer to *NEHRP Design Examples*. The vertical forces, V_u , horizontal forces, H_u , and moments, M_u , are calculated using the applicable strength load combinations.

Concrete Cover Layout and Seismic Forces

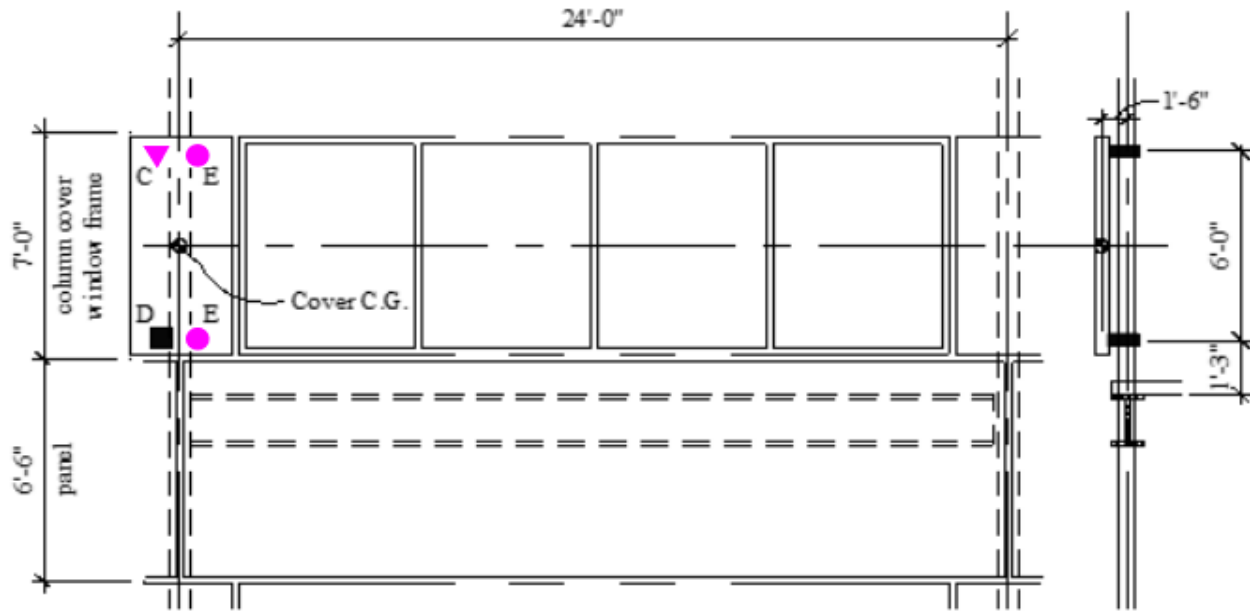

Column cover layout connection

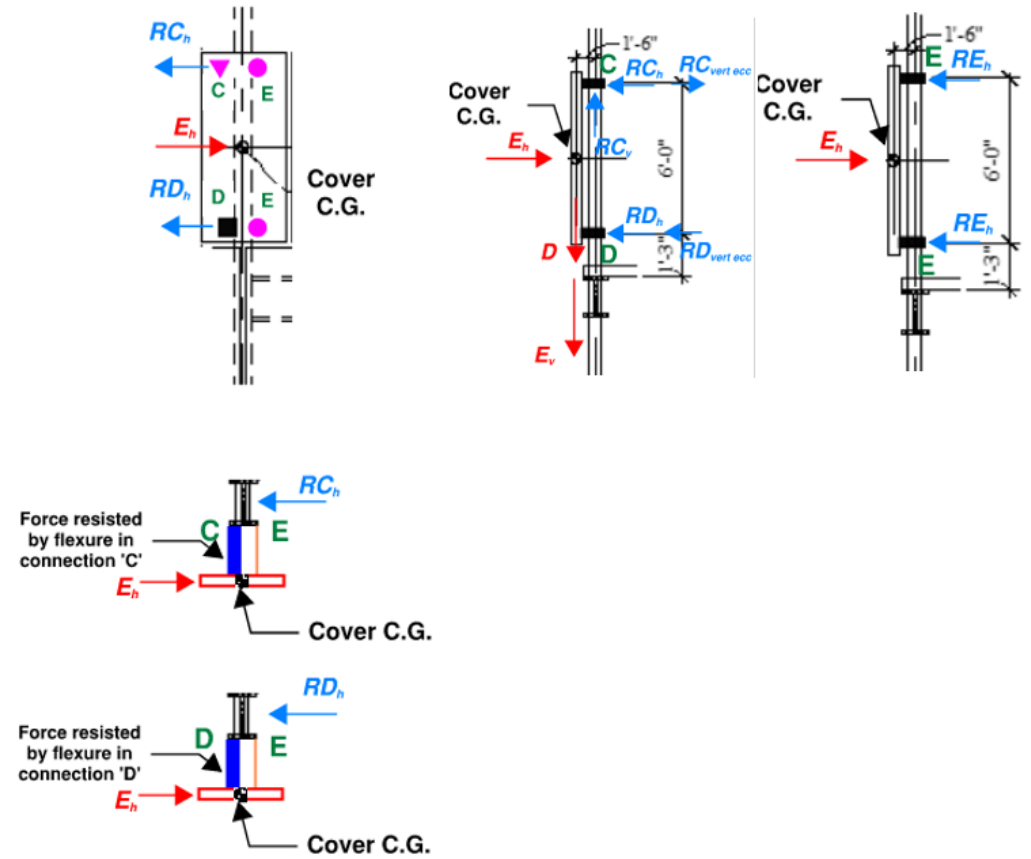

Column cover connection forces

Prescribed Seismic Displacements

- Calculations based on allowable story drift requirements.
- Since this is a five-story building, does not use masonry in the primary seismic force-resisting system, and it is in Risk Category II, the allowable story drift is $0.020h_{sx}$

Story height, $h_{sx} = 13.5$ ft

Height of upper and lower support attachment for column cover, $h_x = 47.75$ ft and $h_y = 41.75$ ft

Seismic relative displacements, D_{pI}

$$D_p = \frac{(h_x - h_y)\Delta_{aA}}{h_{sx}} = \frac{(47.75\text{ft} - 41.75\text{ft})(12 \text{ in./ft})(0.020h_{sx})}{h_{sx}} = 1.44 \text{ in.}$$

$$D_{pI} = D_p I_e = D_p I_e = (1.44 \text{ in.})(1.0) = 1.44 \text{ in.}$$

- The joints at the top and bottom of the column cover must be designed to accommodate an in-plane relative displacement of 1.44 inches.



Prescribed Seismic Displacements: Accommodating Drift in Glazing

- Drift requirements for glazing are in ASCE/SEI 7-22 Section 13.5.9.
- Clearance shall be large enough so that the glass panel will not fall out of the frame as required by $\Delta_{\text{fallout}} \geq \text{maximum}(1.25D_{pl}, 0.5")$
- This can be satisfied in several ways:
 - By test or engineering analysis. The test is AAMA 501.6, *Recommended Dynamic Test Method for determining the Seismic Drift Causing Glass Fallout from a Wall System* (AAMA, 2018).
 - Use fully tempered monolithic glass in Risk Category I, II, or III and less than 10 feet above a walking surface.
 - Use annealed or heat-strengthened laminated glass in single thickness with interlayer no less than 0.030 in. that is captured mechanically in a wall system glazing pocket, and whose perimeter is secured to the frame by a wet glazed gunable curing elastomeric sealant perimeter bead of ½ in. (13mm) minimum glass contact width, or other approved anchorage system.



Prescribed Seismic Displacements: Accommodating Drift in Glazing

- Or the prescriptive formula of Section 13.5.9.1, Exception 1 can be used:

$$D_{clear} = 2c_1 \left(1 + \frac{h_p c_2}{b_p c_1} \right) \geq 1.25 D_{pI} = \text{maximum } (1.25 D_p I_e \text{ and } 0.5'')$$

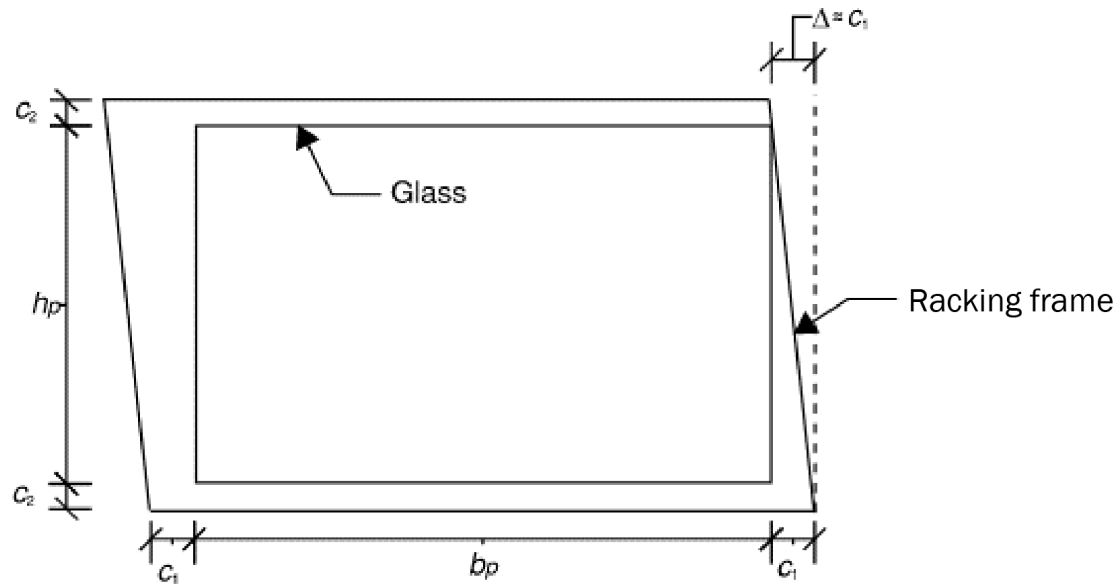

Scenario 1: Glass does not move

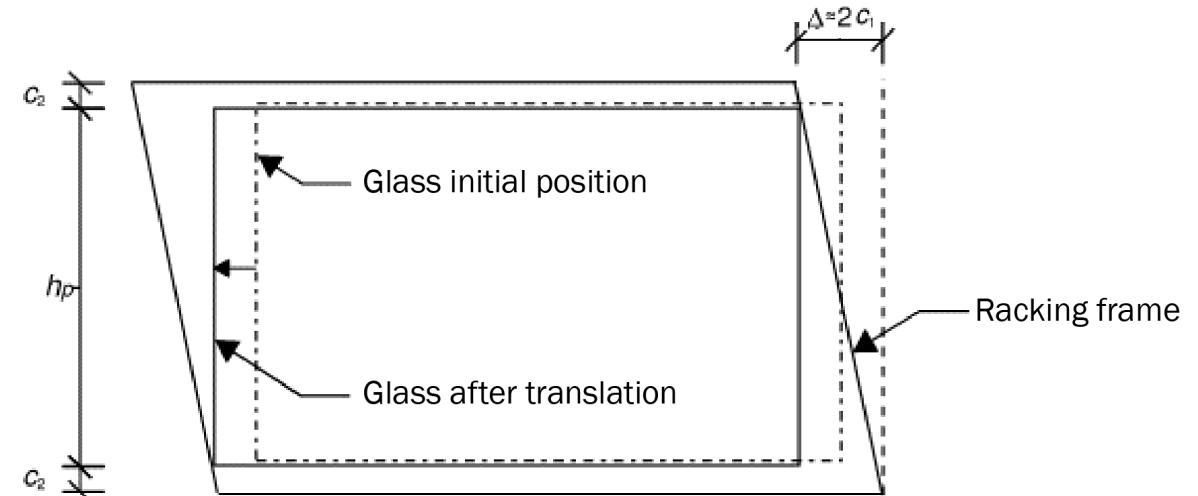

Scenario 2: Glass translates but does not rock

Prescribed Seismic Displacements: Accommodating Drift in Glazing

- Combining translating and rocking gives

$$D_{clear} = 2c_1 \left(1 + \frac{h_p c_2}{b_p c_1} \right)$$

- This assumes the toe of the glass can rotate downward. Limitations on rotation due to location and flexibility of setting blocks under the glass need to be addressed.

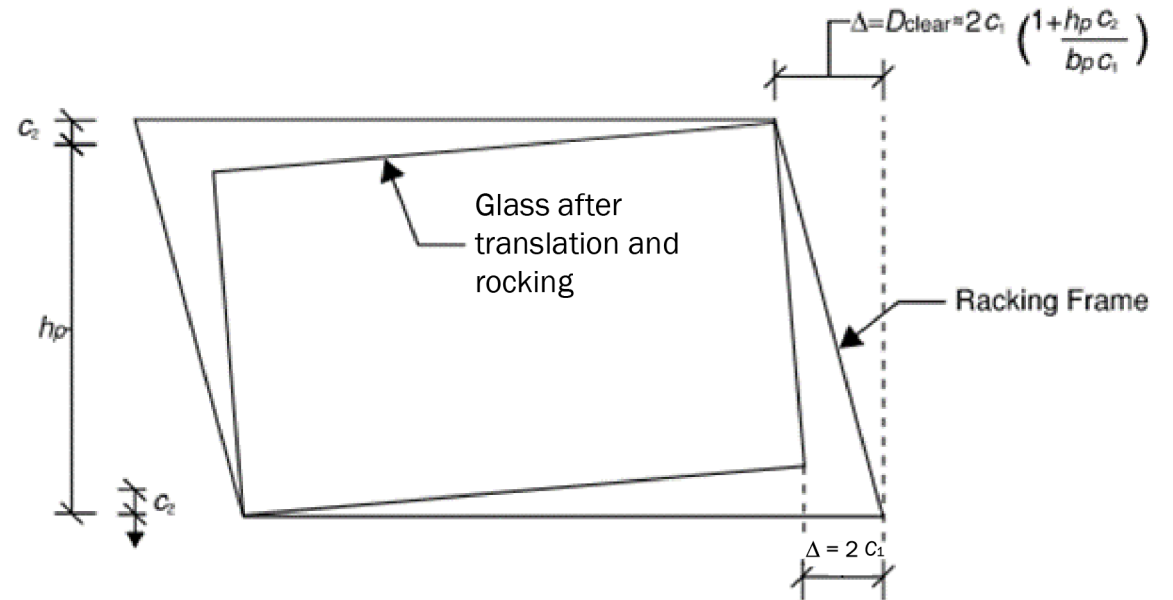

Scenario 3: Glass translates and rocks with vertical movement at both sill and head

Questions?



FEMA



Building Seismic
Safety Council



Seismic Analysis of Egress Stairs

- Prescribed seismic forces
- Prescribed seismic displacements

*Public domain image from
pixabay.com*

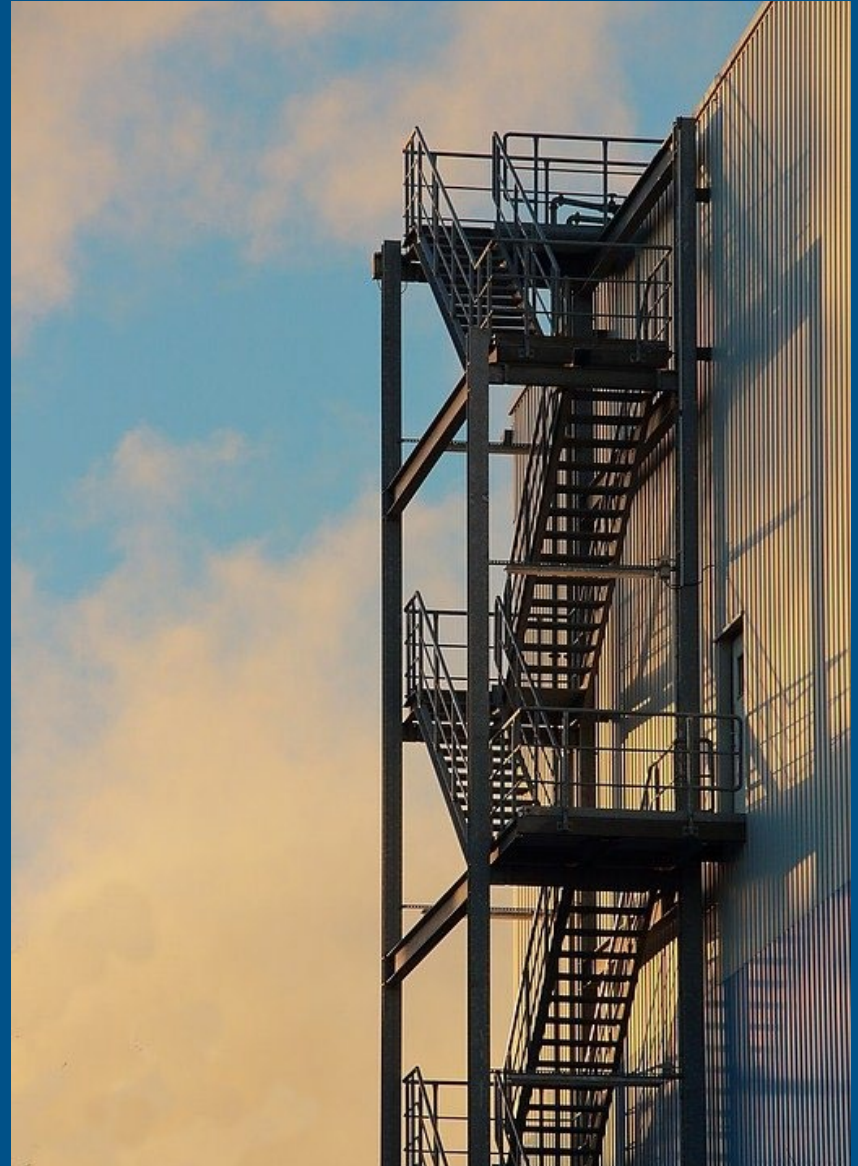

FEMA



Building Seismic
Safety Council



Egress Stairs Description

Example Summary

- **Nonstructural components**
Architectural – egress stairways not part of the building seismic force-resisting system
Architectural – egress stair and ramp fasteners and attachments
- **Building seismic force-resisting systems**
East–west direction: steel special concentrically braced frames
North–south direction: steel special moment frames
- **Equipment support:** Not applicable
- **Occupancy:** Emergency medical facility
- **Risk Category:** IV
- **Component Importance Factor:** $I_p = 1.5$
- **Number of stories:** 5
- $S_{DS} = 1.00$

- Calculations for flight of stairs and landing between Level 3 and Level 4
- Effective dead load: 25 psf
- Design live load: 100 psf



FEMA

 Building Seismic Safety Council



Egress Stairs Description

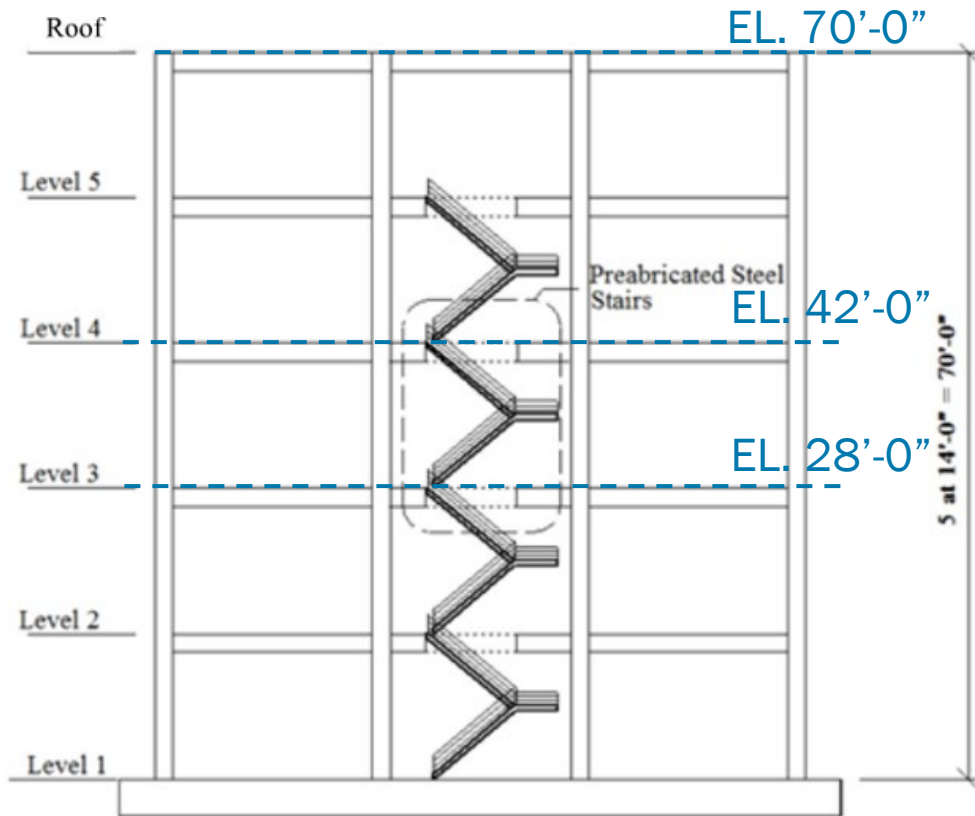

Elevation of egress stairs

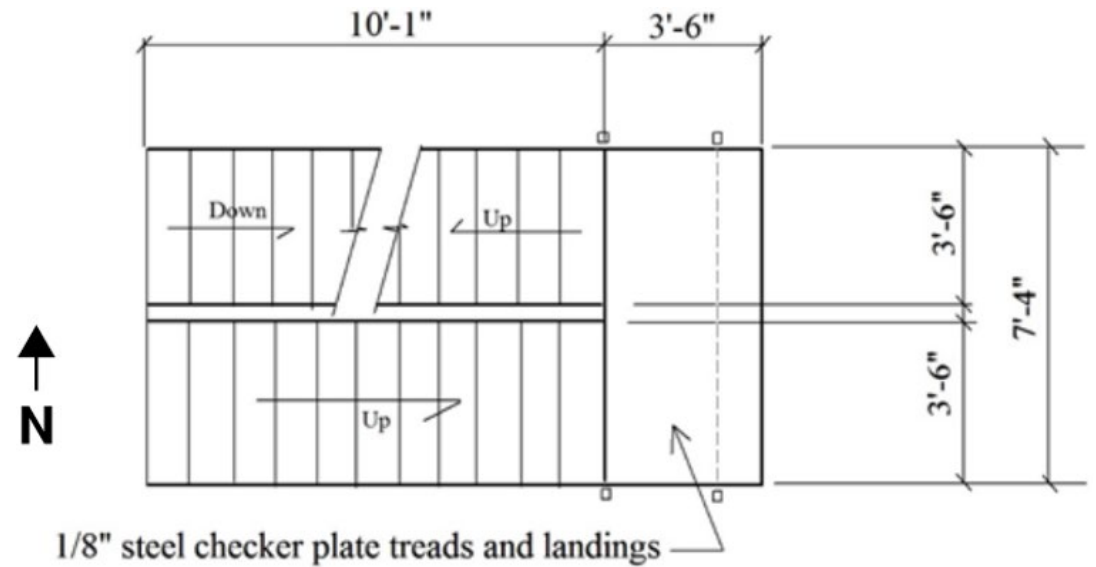

Plan of egress stairs

ASCE/SEI 7-22 Parameters and Coefficients

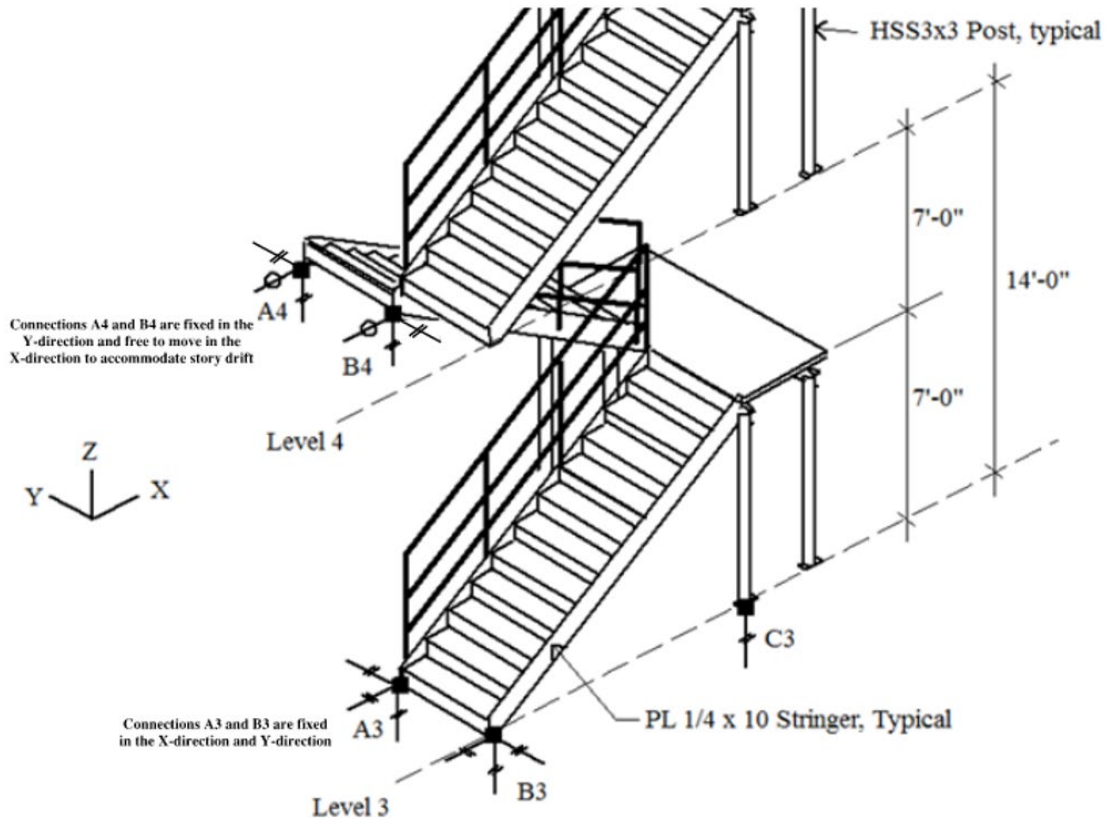

Isometric view of egress stairs

Coefficients for Architectural Components (Table 13.5-1)

- Egress stairways not part of the building seismic force-resisting system:
 - $C_{AR} = 1.0$
 - $R_{po} = 1.5$
 - $\Omega_{0p} = 2.0$
- Egress stairs and ramp fasteners and attachments:
 - $C_{AR} = 2.2$
 - $R_{po} = 1.5$
 - $\Omega_{0p} = 1.75$

ASCE/SEI 7-22 Parameters and Coefficients

- Design coefficients and factors for seismic force-resisting systems (Table 12.2-1)
 - E-W direction – steel SCBF: $R = 6.0$ and $\Omega_0 = 2.0$
 - N-S direction – steel SMRF: $R = 8.0$ and $\Omega_0 = 3.0$
- Short period design spectral acceleration, $S_{DS} = 1.00$
- Seismic Importance Factor, $I_e = 1.5$
- Component Importance Factor, $I_p = 1.5$
- Redundancy factor, $\rho = 1.0$
- Average height of attachments, $z = 35$ ft
- Average roof height, $h = 70$ ft
- Story height, $h_{sx} = 14$ ft



FEMA



Building Seismic
Safety Council



ASCE/SEI 7-22 Parameters and Coefficients

- Stair flight weight, $W_p = \left(20 \frac{\text{lb}}{\text{ft}^2}\right) (10.083 \text{ ft long})(3.5 \text{ ft wide}) = 706 \text{ lb}$
- Stair landing weight, $W_p = \left(20 \frac{\text{lb}}{\text{ft}^2}\right) (7.333 \text{ ft long})(3.5 \text{ ft wide}) = 513 \text{ lb}$

- Approximate fundamental period of the supporting structure, T_a (Section 12.8.2.1)
 - E-W direction – steel SCBF: $T_a = C_t h_n^x = (0.02)(70 \text{ ft})^{0.75} = 0.484 \text{ s}$
 - N-S direction – steel SMRF: $T_a = C_t h_n^x = (0.028)(70 \text{ ft})^{0.8} = 0.838 \text{ s}$

Per Section 13.3.1.1, for structures with combinations of seismic force-resisting systems, the lowest value of T_a shall be used. For this example, $T_a = 0.484 \text{ s}$ controls.



ASCE/SEI 7-22 Parameters and Coefficients

- Force amplification factor as a function of height in the structure, H_f

$$a_1 = \frac{1}{T_a} = \frac{1}{0.484 \text{ s}} = 2.07 \leq 2.5$$

$$a_2 = [1 - (0.4/T_a)^2] = [1 - (0.4/0.484 \text{ s})^2] = 0.32 \geq 0$$

$$H_f = 1 + a_1 \left(\frac{z}{h}\right) + a_2 \left(\frac{z}{h}\right)^{10} = 1 + 2.07 \left(\frac{35 \text{ ft}}{70 \text{ ft}}\right) + 0.32 \left(\frac{35 \text{ ft}}{70 \text{ ft}}\right)^{10} = 2.03$$

- Structure ductility reduction factor, R_μ

$$R_\mu = (1.1 R / (I_e \Omega_0))^{1/2} \geq 1.3$$

- E-W direction - steel SCBF: $R_\mu = (1.1(6 / ((1.5)(2)))^{1/2} = 1.48 \geq 1.3$

- N-S direction - steel SMRF: $R_\mu = (1.1(8 / ((1.5)(3)))^{1/2} = 1.40 \geq 1.3$

Per Section 13.3.1.2, if the structure contains a combination of seismic force-resisting systems in different directions, the lowest value of R_μ shall be used. For this example, $R_\mu = 1.40$ controls.



Applicable Requirements

- Supports, attachments, and the egress stairs themselves shall be designed to meet the seismic requirements of Chapter 13 (Section 13.2.1).
- Component failure shall not cause failure of an essential architectural, mechanical, or electrical component (Section 13.2.4).
- Seismic attachments shall be bolted, welded, or otherwise positively fastened without considering the frictional resistance produced by the effects of gravity (Section 13.4).
- F_p shall be applied at the component's center of gravity and distributed relative to the component's mass distribution (Section 13.3.1).
- Effects of seismic relative displacements shall be considered in combination with displacements caused by other loads as appropriate (Section 13.3.2).



FEMA

 Building Seismic
Safety Council



Applicable Requirements (Continued)

- The net relative displacement shall be assumed to occur in any horizontal direction, and it shall be accommodated through slotted or sliding connections, or metal supports designed with rotation capacity to accommodate D_{pI} (Section 13.5.10).
- Sliding connections with slotted or oversize holes, sliding bearing supports with restraints that engage after the displacement, D_{pI} , is exceeded, and connections that permit movement by deformation of metal attachments, shall accommodate a displacement D_{pI} , but not less than 0.5 in. (13 mm), without loss of vertical support or inducement of displacement-related compression forces in the stair (Section 13.5.10).
- The strength of the supports shall not be limited by bolt shear, weld fracture, or other limit states with lesser ductility (Section 13.5.10).



FEMA

 Building Seismic
Safety Council



Prescribed Seismic Forces: Egress Stairways not Part of the Building Seismic Force-Resisting System

Flight of Stairs

- Component weight, $W_p = D = 706$ lb
- Seismic design force, F_p

$$F_p = 0.4S_{DS}I_pW_p \left[\frac{H_f}{R_\mu} \right] \left[\frac{C_{AR}}{R_{po}} \right] = 0.4(1.0)(1.5)(W_p) \left[\frac{2.03}{1.40} \right] \left[\frac{1.0}{1.5} \right] = 0.582W_p \quad (\text{controlling equation})$$

$$F_{p,max} = 1.6S_{DS}I_pW_p = 1.6(1.0)(1.5)(W_p) = 2.4W_p$$

$$F_{p,min} = 0.3S_{DS}I_pW_p = 0.3(1.0)(1.5)(W_p) = 0.45W_p$$

$$F_p = 0.582W_p = 0.582(706 \text{ lb}) = 410 \text{ lb} \quad (\text{controlling seismic design force})$$



Prescribed Seismic Forces: Egress Stairways not Part of the Building Seismic Force-Resisting System

Flight of Stairs (Continued)

- Horizontal seismic load effect, E_h

$$Q_E = F_p = 410 \text{ lb}$$

$$E_h = \rho Q_E = (1.0)(335 \text{ lb}) = 410 \text{ lb}$$

- Vertical seismic load effect, E_v

$$E_v = 0.2S_{DS}D = (0.2)(1.0g)(706 \text{ lb}) = 141 \text{ lb}$$

- Basic Load Combinations for Strength Design to determine the design member and connection forces to be used in conjunction with seismic and gravity loads:

$$1.2D + E_v + E_h + L + 0.2S \quad (\text{Load Combination 6})$$

$$0.9D - E_v + E_h \quad (\text{Load Combination 7})$$



Prescribed Seismic Forces: Egress Stairways not Part of the Building Seismic Force-Resisting System

Landing

- Component weight, $W_p = D = 513$ lb
- Seismic design force, F_p

$$F_p = 0.4S_{DS}I_pW_p \left[\frac{H_f}{R_\mu} \right] \left[\frac{C_{AR}}{R_{po}} \right] = 0.4(1.0)(1.5)(W_p) \left[\frac{2.03}{1.40} \right] \left[\frac{1.0}{1.5} \right] = 0.582W_p \quad (\text{controlling equation})$$

$$F_{p,max} = 1.6S_{DS}I_pW_p = 1.6(1.0)(1.5)(W_p) = 2.4W_p$$

$$F_{p,min} = 0.3S_{DS}I_pW_p = 0.3(1.0)(1.5)(W_p) = 0.45W_p$$

$$F_p = 0.582W_p = 0.582(513 \text{ lb}) = 298 \text{ lb} \quad (\text{controlling seismic design force})$$



Prescribed Seismic Forces: Egress Stairways not Part of the Building Seismic Force-Resisting System

Landing (Continued)

- Horizontal seismic load effect, E_h

$$Q_E = F_p = 298 \text{ lb}$$

$$E_h = \rho Q_E = (1.0)(298 \text{ lb}) = 298 \text{ lb}$$

- Vertical seismic load effect, E_v

$$E_v = 0.2S_{DS}D = (0.2)(1.0g)(513 \text{ lb}) = 103 \text{ lb}$$

- Basic Load Combinations for Strength Design to determine the design member and connection forces to be used in conjunction with seismic and gravity loads:

$$1.2D + E_v + E_h + L + 0.2S \quad (\text{Load Combination 6})$$

$$0.9D - E_v + E_h \quad (\text{Load Combination 7})$$



Increased Seismic Forces for Fasteners and Attachments

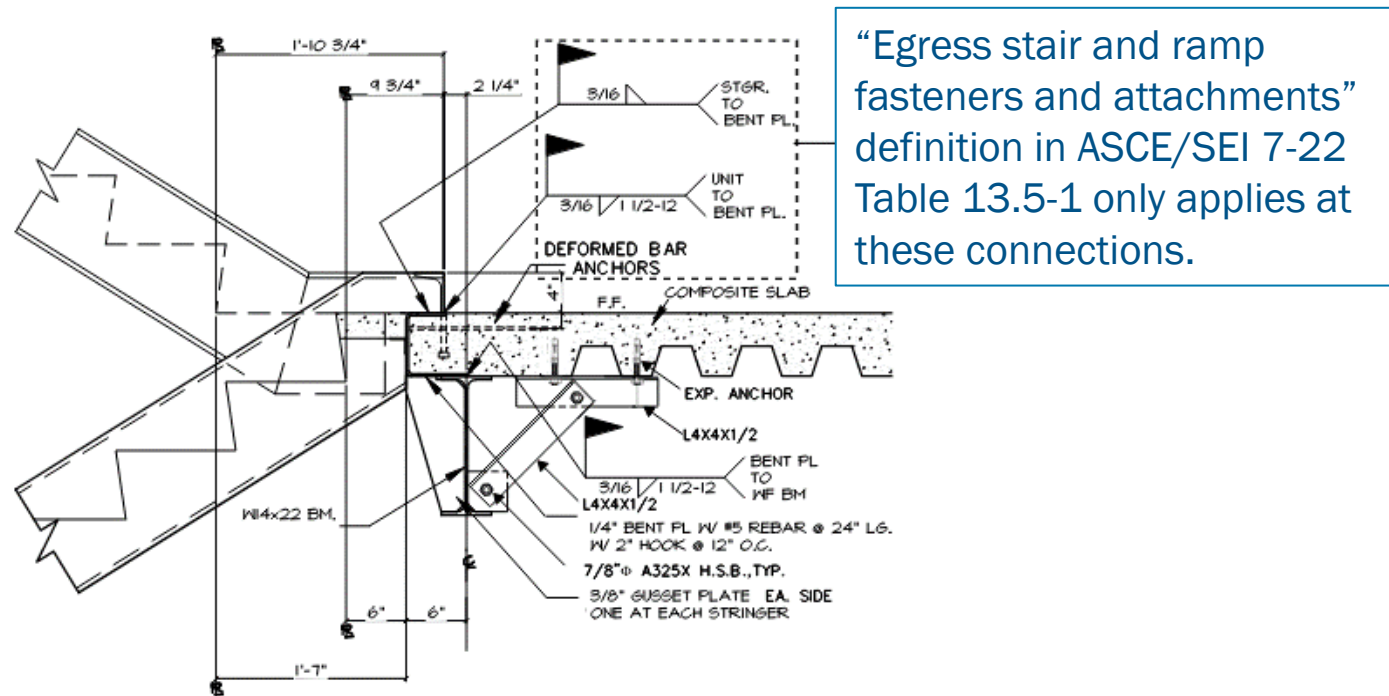

Connection of stair to primary structure

- The attachment to the primary structure is not well delimited to the rest of the egress stairway connections.
- It is recommended to apply the increased design forces in attachments with a nonductile failure mechanism.

Prescribed Seismic Forces: Egress Stairs and Ramp Fasteners and Attachments

Flight of Stairs

- Component weight, $W_p = D = 706$ lb
- Seismic design force, F_p

$$F_p = 0.4S_{DS}I_pW_p \left[\frac{H_f}{R_\mu} \right] \left[\frac{C_{AR}}{R_{po}} \right] = 0.4(1.0)(1.5)(W_p) \left[\frac{2.03}{1.40} \right] \left[\frac{2.2}{1.5} \right] = 1.280W_p \quad (\text{controlling equation})$$

$$F_{p,max} = 1.6S_{DS}I_pW_p = 1.6(1.0)(1.5)(W_p) = 2.4W_p$$

$$F_{p,min} = 0.3S_{DS}I_pW_p = 0.3(1.0)(1.5)(W_p) = 0.45W_p$$

$$F_p = 1.280W_p = 1.280(706 \text{ lb}) = 903 \text{ lb} \quad (\text{controlling seismic design force})$$

- Compare increased design force, $F_p = 903$ lb for fasteners and attachments, against $F_p = 410$ lb for design of rest of egress stairs.



Prescribed Seismic Forces: Egress Stairs and Ramp Fasteners and Attachments

Landing

- Component weight, $W_p = D = 513$ lb
- Seismic design force, F_p

$$F_p = 0.4S_{DS}I_pW_p \left[\frac{H_f}{R_\mu} \right] \left[\frac{C_{AR}}{R_{po}} \right] = 0.4(1.0)(1.5)(W_p) \left[\frac{2.03}{1.40} \right] \left[\frac{2.2}{1.5} \right] = 1.280W_p \quad (\text{controlling equation})$$

$$F_{p,max} = 1.6S_{DS}I_pW_p = 1.6(1.0)(1.5)(W_p) = 2.4W_p$$

$$F_{p,min} = 0.3S_{DS}I_pW_p = 0.3(1.0)(1.5)(W_p) = 0.45W_p$$

$$F_p = 1.280W_p = 1.280(513 \text{ lb}) = 657 \text{ lb} \quad (\text{controlling seismic design force})$$

- Compare increased design force, $F_p = 657$ lb for fasteners and attachments, against $F_p = 298$ lb for design of rest of egress stairs.



Prescribed Seismic Displacements

- Calculations based on allowable story drift requirements.
- Since this is a five-story building, does not use masonry in the primary seismic force-resisting system, and it is in Risk Category IV, the allowable story drift is $0.010h_{sx}$.

Story height, $h_{sx} = 14$ ft

Height of upper and lower support attachment, $h_x = 42$ ft and $h_y = 28$ ft

Seismic relative displacements, D_{pI}

$$D_p = \frac{(h_x - h_y)\Delta_{aA}}{h_{sx}} = \frac{(42\text{ft} - 28\text{ft})(12\text{ in./ft})(0.010h_{sx})}{h_{sx}} = 1.68\text{ in.}$$

$$D_{pI} = D_p I_e = (1.68\text{ in.})(1.5) = 2.52\text{ in.}$$

- The displacement can act in any direction, so the connection must be able to accommodate a total range of movement of two times D_{pI} , or $2 \times D_{pI} = 5.04$ in. in all directions.



Stairway Design Load Combinations

- The egress stairway and connections should be designed for the linear combination:

Design Load Combination = Inertial Force Demand + Displacement-Induced Demand

- For this example, the following load combinations would be required in the analysis:

$$EQX = \pm F_{pX}$$

$$EQY = \pm F_{pY} \pm EQY_{drift}$$

- The unrestrained connection in the X-direction (longitudinal direction) and the induced demand at the fixed connection in the Y-direction (transverse direction) at Level 4 shall be able to accommodate the story drift, and the seismic relative displacements.



FEMA

 Building Seismic
Safety Council



Questions?



FEMA



Building Seismic
Safety Council



HVAC Fan Unit Support

- Case 1: Direct attachment to structure
- Case 2: Support on vibration isolation springs



*Public domain image from
pixabay.com*



FEMA



Building Seismic
Safety Council



HVAC Fan Unit Support Description

Example Summary

- **Nonstructural components**

Case 1: Mechanical and electrical – HVAC fan unit

Case 2: Mechanical and electrical – spring-isolated component

- **Building seismic force-resisting system:** Ordinary reinforced masonry shear wall (bearing wall system)
- **Equipment support:** Integral
- **Occupancy:** Office
- **Risk Category:** II
- **Component Importance Factor:** $I_p = 1.0$
- **Number of stories:** 3
- $S_{DS} = 0.474$

- 4-foot high, 5-foot-wide, 8-foot-long, 3,000-pound HVAC fan unit that is supported on two long sides near each corner
- 4,000 psi normalweight concrete roof slab
- Three-story office building. All stories are 12-feet tall.



FEMA

 Building Seismic Safety Council



HVAC Fan Unit Support Description

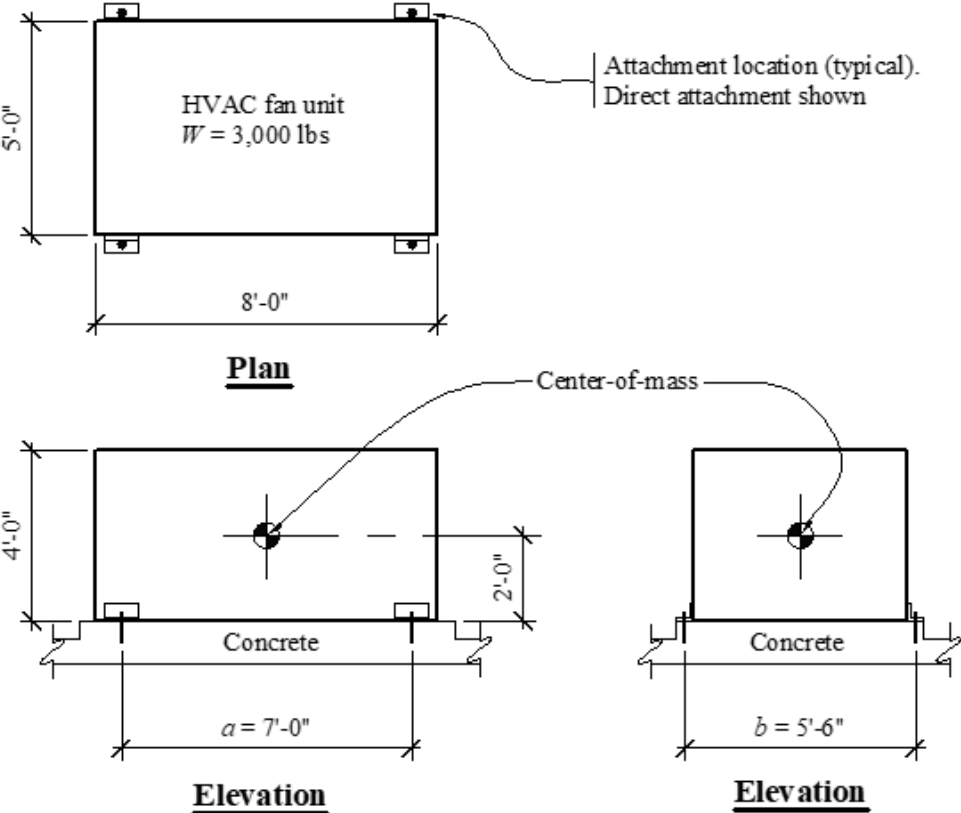

HVAC Fan Unit

- **Case 1:** Direct attachment to the structure using 36 ksi, carbon steel, cast-in place anchors
- **Case 2:** Support on vibration isolation springs that are attached to the slab with 36 ksi, carbon steel, post-installed expansion anchors. The nominal gap between the vibration spring seismic restraints and the base frame of the fan unit is presumed to be greater than 0.25 in.



FEMA

Building Seismic Safety Council



ASCE/SEI 7-22 Parameters and Coefficients

Coefficients for Mechanical and Electrical Components (Table 13.6-1)

- Air-side HVACR, fans, air handlers, air conditioning units, cabinet heaters, air distribution boxes, and other mechanical components constructed of sheet metal framing:
 - $C_{AR} = 1.4$
 - $R_{po} = 2.0$
 - $\Omega_{0p} = 2.0$
- Spring-isolated components and systems and vibration-isolated floors closely restrained using built-in or separate elastomeric snubbing devices or resilient perimeter stops:
 - $C_{AR} = 2.2$
 - $R_{po} = 1.3$
 - $\Omega_{0p} = 1.75$



ASCE/SEI 7-22 Parameters and Coefficients

- Design coefficients and factors for seismic force-resisting system (Table 12.2-1)
 - Bearing wall system – ordinary reinforced masonry shear wall: $R = 2.0$ and $\Omega_0 = 2.5$
- Short period design spectral acceleration, $S_{DS} = 0.474$
- Seismic Importance Factor, $I_e = 1.0$
- Component Importance Factor, $I_p = 1.0$
- Redundancy factor, $\rho = 1.0$
- Height of attachment at roof, $z = 36$ ft
- Average roof height, $h = 36$ ft



FEMA



Building Seismic
Safety Council



ASCE/SEI 7-22 Parameters and Coefficients

- HVAC fan unit weight, $W_p = 3,000$ lb
- Approximate fundamental period of the supporting structure, T_a (Section 12.8.2.1)

Ordinary reinforced masonry shear walls (all other structural systems, per Table 12.8-2):

$$h_n = h = 36 \text{ ft}$$

$$C_t = 0.02$$

$$x = 0.75$$

$$T_a = C_t h_n^x = (0.02)(36 \text{ ft})^{0.75} = 0.29 \text{ s}$$



ASCE/SEI 7-22 Parameters and Coefficients

- Force amplification factor as a function of height in the structure, H_f

$$a_1 = \frac{1}{T_a} = \frac{1}{0.29 \text{ s}} = 3.45 > 2.5, \text{ use } a_1 = 2.5$$

$$a_2 = [1 - (0.4/T_a)^2] = [1 - (0.4/0.29 \text{ s})^2] = -0.90 < 0, \text{ use } a_2 = 0$$

$$H_f = 1 + a_1 \left(\frac{z}{h}\right) + a_2 \left(\frac{z}{h}\right)^{10} = 1 + 2.5 \left(\frac{36 \text{ ft}}{36 \text{ ft}}\right) + 0 \left(\frac{36 \text{ ft}}{36 \text{ ft}}\right)^{10} = 3.5$$

For supporting structures with $T_a \leq 0.4 \text{ s}$, the parameters a_1 and a_2 are controlled by their limits, i.e., $a_1 = 2.5$ and $a_2 = 0$.

- Structure ductility reduction factor, R_μ

$$R_\mu = (1.1 R / (I_e \Omega_0))^{1/2} = (1.1(2 / ((1.0)(2.5)))^{1/2} = 0.94 < 1.3, \text{ use } R_\mu = 1.3$$



Applicable Requirements

- Component failure shall not cause failure of an essential architectural, mechanical, or electrical component (Section 13.2.4).
- Seismic attachments shall be bolted, welded, or otherwise positively fastened without considering the frictional resistance produced by the effects of gravity (Section 13.4).
- F_p shall be applied at the component's center of gravity and distributed relative to the component's mass distribution (Section 13.3.1).
- Attachments to concrete or masonry shall be designed to resist the seismic load effects including overstrength, Ω_0 shall be taken as Ω_{0p} (Section 13.4.2).
- Exterior nonstructural wall panels or elements that are attached to or enclose the structure shall be designed to accommodate the seismic relative displacements, and movements caused by temperature changes (Section 13.5.3).



Applicable Requirements (Continued)

- Attachments and supports transferring seismic loads shall be constructed of materials suitable for the application and must be designed and constructed in accordance with a nationally recognized structural standard (Section 13.6.4.4).
- Components mounted on vibration isolation systems shall have a bumper restraint or snubber in each horizontal direction. Vertical restraints must be provided where required to resist overturning. Isolator housings and restraints must also be constructed of ductile materials. A viscoelastic pad, or similar material of appropriate thickness, must be used between the bumper and equipment item to limit the impact load. **Such components also must resist doubled seismic design forces if the nominal clearance (air gap) between the equipment support frame and restraints is greater than 0.25 in.** (Section 13.6.4.5 and Table 13.6-1, Footnote a).



FEMA



Building Seismic
Safety Council



Prescribed Seismic Forces: Case 1: Direct Attachment to Structure

- HVAC fan unit weight, $W_p = D = 3,000$ lb
- Seismic design force, F_p

$$F_p = 0.4S_{DS}I_pW_p \left[\frac{H_f}{R_\mu} \right] \left[\frac{C_{AR}}{R_{po}} \right] = 0.4(0.474)(1.0)(W_p) \left[\frac{3.5}{1.3} \right] \left[\frac{1.4}{2.0} \right] = 0.357W_p \text{ (controlling equation)}$$

$$F_{p,max} = 1.6S_{DS}I_pW_p = 1.6(0.474)(1.0)(W_p) = 0.758W_p$$

$$F_{p,min} = 0.3S_{DS}I_pW_p = 0.3(0.474)(1.0)(W_p) = 0.142W_p$$

$$F_p = 0.357W_p = 0.357(3,000 \text{ lb}) = 1,072 \text{ lb} \quad \text{(controlling seismic design force)}$$



Prescribed Seismic Forces: Case 1: Direct Attachment to Structure

- Horizontal seismic load effect, E_h

$$Q_E = F_p = 1,072 \text{ lb}$$

$$E_h = \rho Q_E = (1.0)(1,072 \text{ lb}) = 1,072 \text{ lb}$$

- Vertical seismic load effect, E_v

$$E_v = 0.2S_{DS}D = (0.2)(0.474g)(3,000 \text{ lb}) = 284 \text{ lb}$$

- Basic Load Combinations for Strength Design to determine the design member and connection forces to be used in conjunction with seismic loads:

$$1.2D + E_v + E_h + L + 0.2S \quad (\text{Load Combination 6})$$

$$0.9D - E_v + E_h \quad (\text{Load Combination 7})$$

For nonstructural components, the terms L and S are typically zero.



Proportioning and Design: Case 1: Direct Attachment to Structure

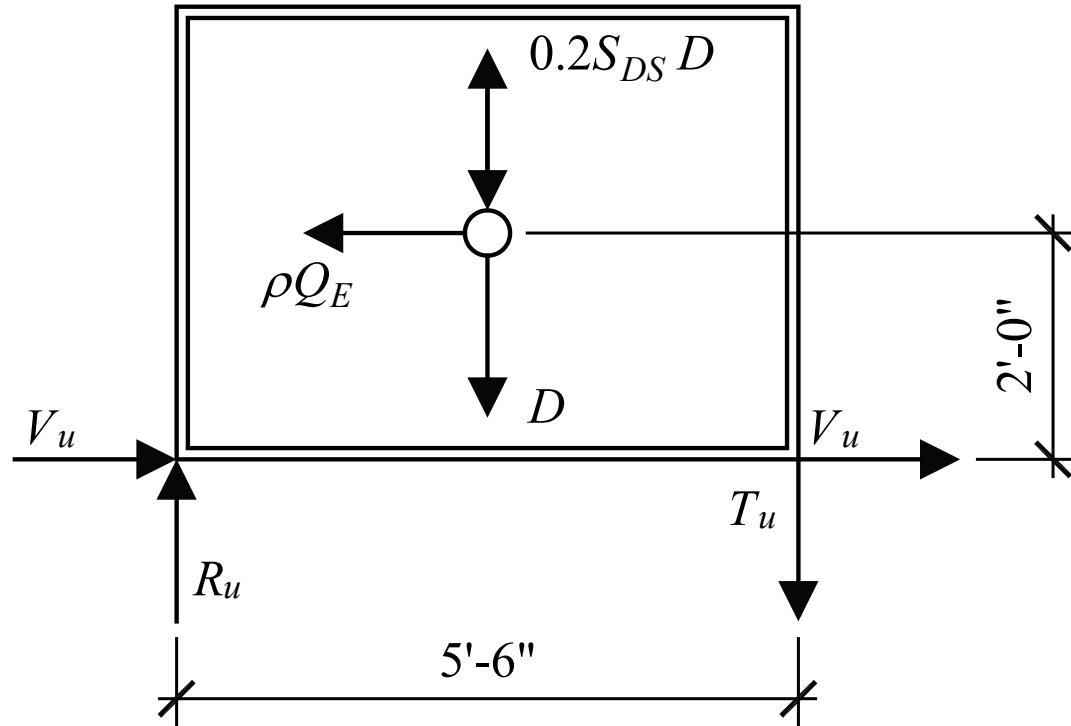

Free-body diagram for seismic force analysis

- Seismic load effects are used to determine bolt shear, V_u , and tension, T_u (where a negative value indicates tension)
- Signs of E_v and E_h are selected to result in the largest value of T_u

Proportioning and Design: Case 1: Direct Attachment to Structure

- Basic Load Combination 6: $1.2D + E_v + E_h + L + 0.2S$

$$V_u = \frac{E_h}{4 \text{ bolts}} = \frac{1,072 \text{ lb}}{4 \text{ bolts}} = 268 \text{ lb/bolt}$$

$$T_u = \frac{(1.2D - E_v)(5.5/2 \text{ ft}) - (E_h)(2 \text{ ft})}{(5.5 \text{ ft})(2 \text{ bolts})} = \frac{(1.2(3,000 \text{ lb}) - 284 \text{ lb})(5.5/2 \text{ ft}) - (1,072 \text{ lb})(2 \text{ ft})}{(5.5 \text{ ft})(2 \text{ bolts})} = 634 \text{ lb/bolt (no tension)}$$

- Basic Load Combination 6: $0.9D - E_v + E_h$

$$V_u = \frac{E_h}{4 \text{ bolts}} = \frac{1,072 \text{ lb}}{4 \text{ bolts}} = 268 \text{ lb/bolt}$$

$$T_u = \frac{(0.9D - E_v)(5.5/2 \text{ ft}) - (E_h)(2 \text{ ft})}{(5.5 \text{ ft})(2 \text{ bolts})} = \frac{(0.9(3,000 \text{ lb}) - 284 \text{ lb})(5.5/2 \text{ ft}) - (1,072 \text{ lb})(2 \text{ ft})}{(5.5 \text{ ft})(2 \text{ bolts})} = 409 \text{ lb/bolt (no tension)}$$

- Anchors with design capacities exceeding the calculated demands would be selected using ACI 318 Chapter 17.



Prescribed Seismic Forces: Case 2: Support on Vibration Isolation Springs

- HVAC fan unit weight, $W_p = D = 3,000$ lb
- Seismic design force, F_p

$$F_p = 0.4S_{DS}I_pW_p \left[\frac{H_f}{R_\mu} \right] \left[\frac{C_{AR}}{R_{po}} \right] = 0.4(0.474)(1.0)(W_p) \left[\frac{3.5}{1.3} \right] \left[\frac{2.2}{1.3} \right] = 0.864W_p$$

$$F_{p,max} = 1.6S_{DS}I_pW_p = 1.6(0.474)(1.0)(W_p) = 0.758W_p \quad (\text{controlling equation})$$

$$F_{p,min} = 0.3S_{DS}I_pW_p = 0.3(0.474)(1.0)(W_p) = 0.142W_p$$

$$F_p = 0.758W_p = 0.758(3,000 \text{ lb}) = 2,275 \text{ lb} \quad (\text{controlling seismic design force})$$



Prescribed Seismic Forces:

Case 2: Support on Vibration Isolation Springs

- Per Table 13.6-1 Footnote a, the design force should be taken as $2F_p$ if nominal clearance (air gap) between equipment and seismic restraint is greater than 0.25 in.

- Horizontal seismic load effect, E_h

$$Q_E = 2F_p = 2(2,275 \text{ lb}) = 4,550 \text{ lb}$$

$$E_h = \rho Q_E = (1.0)(4,550 \text{ lb}) = 4,550 \text{ lb}$$

- Vertical seismic load effect, E_v

$$E_v = 0.2S_{DS}D = (0.2)(0.474g)(3,000 \text{ lb}) = 284 \text{ lb}$$

- Basic Load Combinations for Strength Design to determine the design member and connection forces to be used in conjunction with seismic loads:

$$1.2D + E_v + E_h + L + 0.2S \quad (\text{Load Combination 6})$$

$$0.9D - E_v + E_h \quad (\text{Load Combination 7})$$



Proportioning and Design: Case 2: Support on Vibration Isolation Springs

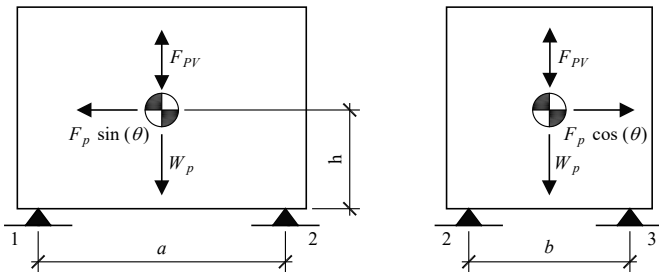
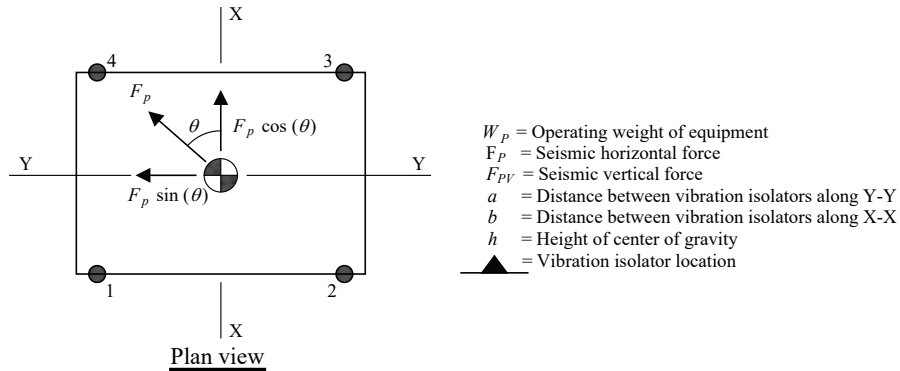

ASHRAE diagonal analysis for vibration isolation springs

- The seismic load effects are used to determine the bolt shear, V_u , and tension, T_u (negative value indicates tension).
- Design forces are determined by an analysis of earthquake forces applied in a diagonal horizontal direction.
- ASHRAE A56 equations are used to estimate these demands.

Angle of diagonal bending, $\theta = \tan^{-1} \left(\frac{b}{a} \right)$

For this example, $\theta = \tan^{-1} \left(\frac{5.5 \text{ ft}}{7.0 \text{ ft}} \right) = 38.16^\circ$

Tension per isolator, $T_u = \frac{W_p - F_{pv}}{4} - \frac{F_p h}{2} \left(\frac{\cos \theta}{b} + \frac{\sin \theta}{a} \right)$

Compression per isolator, $C_u = \frac{W_p + F_{pv}}{4} + \frac{F_p h}{2} \left(\frac{\cos \theta}{b} + \frac{\sin \theta}{a} \right)$

Shear per isolator, $V_u = \frac{F_p}{4}$

Proportioning and Design: Case 2: Support on Vibration Isolation Springs

- Basic Load Combination 6: $1.2D + E_v + E_h + L + 0.2S$

$$T_u = \frac{1.2D - E_v}{4} - \frac{E_h h}{2} \left(\frac{\cos \theta}{b} + \frac{\sin \theta}{a} \right) = \frac{1.2(3,000 \text{ lb}) - 284 \text{ lb}}{4} - \frac{(4,550 \text{ lb})(2 \text{ ft})}{2} \left(\frac{\cos(38.16^\circ)}{5.5 \text{ ft}} + \frac{\sin(38.16^\circ)}{7 \text{ ft}} \right) = -223 \text{ lb}$$

$$C_u = \frac{1.2D + E_v}{4} + \frac{E_h h}{2} \left(\frac{\cos \theta}{b} + \frac{\sin \theta}{a} \right) = \frac{1.2(3,000 \text{ lb}) + 284 \text{ lb}}{4} + \frac{(4,550 \text{ lb})(2 \text{ ft})}{2} \left(\frac{\cos(38.16^\circ)}{5.5 \text{ ft}} + \frac{\sin(38.16^\circ)}{7 \text{ ft}} \right) = 2,023 \text{ lb}$$

$$V_u = \frac{E_h}{4} = \frac{4,550 \text{ lb}}{4} = 1,138 \text{ lb}$$

- Basic Load Combination 6: $0.9D + E_v + E_h + L + 0.2S$

$$T_u = \frac{0.9D - E_v}{4} - \frac{E_h h}{2} \left(\frac{\cos \theta}{b} + \frac{\sin \theta}{a} \right) = \frac{0.9(3,000 \text{ lb}) - 284 \text{ lb}}{4} - \frac{(4,550 \text{ lb})(2 \text{ ft})}{2} \left(\frac{\cos(38.16^\circ)}{5.5 \text{ ft}} + \frac{\sin(38.16^\circ)}{7 \text{ ft}} \right) = -448 \text{ lb}$$

$$C_u = \frac{0.9D + E_v}{4} + \frac{E_h h}{2} \left(\frac{\cos \theta}{b} + \frac{\sin \theta}{a} \right) = \frac{0.9(3,000 \text{ lb}) + 284 \text{ lb}}{4} + \frac{(4,550 \text{ lb})(2 \text{ ft})}{2} \left(\frac{\cos(38.16^\circ)}{5.5 \text{ ft}} + \frac{\sin(38.16^\circ)}{7 \text{ ft}} \right) = 1,798 \text{ lb}$$

$$V_u = \frac{E_h}{4} = \frac{4,550 \text{ lb}}{4} = 1,138 \text{ lb}$$

- The vibration isolator would be designed to resist these forces.



Proportioning and Design: Case 2: Support on Vibration Isolation Springs

- There is no component or a support that undergoes ductile yielding at a load level less than the design strength of the corresponding anchor.
- The Basic Load Combination 7 including Ω_{op} is applied to obtain the controlling vertical design tension force.

Tension per isolator:

$$T_u = \frac{0.9D - E_v}{4} - \frac{\Omega_{op} E_h h}{2} \left(\frac{\cos \theta}{b} + \frac{\sin \theta}{a} \right) =$$
$$T_u = \frac{0.9(3,000 \text{ lb}) - 284 \text{ lb}}{4} - \frac{(1.75)(4,550 \text{ lb})(2 \text{ ft})}{2} \left(\frac{\cos(38.16^\circ)}{5.5 \text{ ft}} + \frac{\sin(38.16^\circ)}{7 \text{ ft}} \right) = -1,237 \text{ lb}$$

Acting concurrently with tension, the horizontal design shear force is:

$$V_u = \frac{\Omega_{op} E_h}{4} = \frac{(1.75)(4,550 \text{ lb})}{4} = 1,991 \text{ lb}$$



Proportioning and Design: Case 2: Support on Vibration Isolation Springs

- Horizontal shear force applied at the top of the isolator generates a moment that induces prying action, which will increase the tension on the anchor.
- Each isolator is attached to the concrete slab with two anchors.
- Tension force per anchor including prying effects, T_b :

$$T_b = \frac{T_u}{2 \text{ anchors}} - \left(\frac{5 \text{ in.}}{2 \text{ in.}} \right) \left(\frac{V_u}{2 \text{ anchors}} \right)$$

$$T_b = \frac{-1,237 \text{ lb}}{2 \text{ anchors}} - \left(\frac{5 \text{ in.}}{2 \text{ in.}} \right) \left(\frac{1,991 \text{ lb}}{2 \text{ anchors}} \right) = -3,107 \text{ lb}$$

- Design shear force per bolt, V_b :

$$V_b = \frac{V_u}{2 \text{ anchors}} = \frac{1,991 \text{ lb}}{2 \text{ anchors}} = 995 \text{ lb}$$

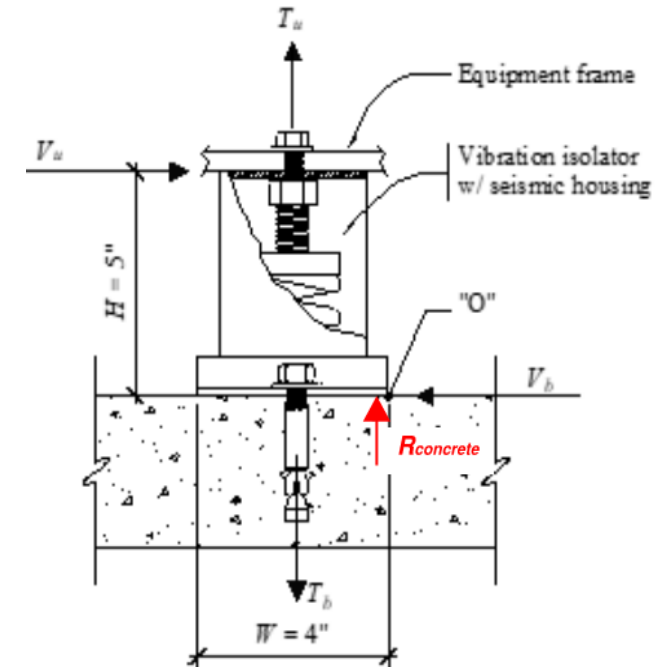

Anchor and snubber loads for support on vibration isolation springs

Questions?



FEMA



Building Seismic
Safety Council



Piping System Seismic Design

- Piping system design
- Pipe supports and bracing
- Prescribed seismic displacements



*Image from FEMA E-74 (2012)
Figure 6.4.3.1-5 (courtesy of
Mason Industries)*



FEMA



Building Seismic
Safety Council



Piping System Description

Example Summary

- **Nonstructural components:** Mechanical and electrical – piping not in accordance with ASME B31 with threaded joints
- **Building seismic force-resisting system:** Steel buckling-restrained braced frames
- **Equipment support:** Distribution system supports – distribution system supports using hot-rolled steel bracing
- **Occupancy:** Acute care hospital
- **Risk Category:** IV
- **Component Importance Factor:** $I_p = 1.5$
- **Number of stories:** 2
- $S_{DS} = 1.00$

- Three piping runs of a chilled water piping system supported from the roof.
- The system is not intended to meet the ASME B31 requirements.
- One run of the piping system crosses a seismic separation joint to enter an adjacent structure.



FEMA

 Building Seismic Safety Council



Piping System Description

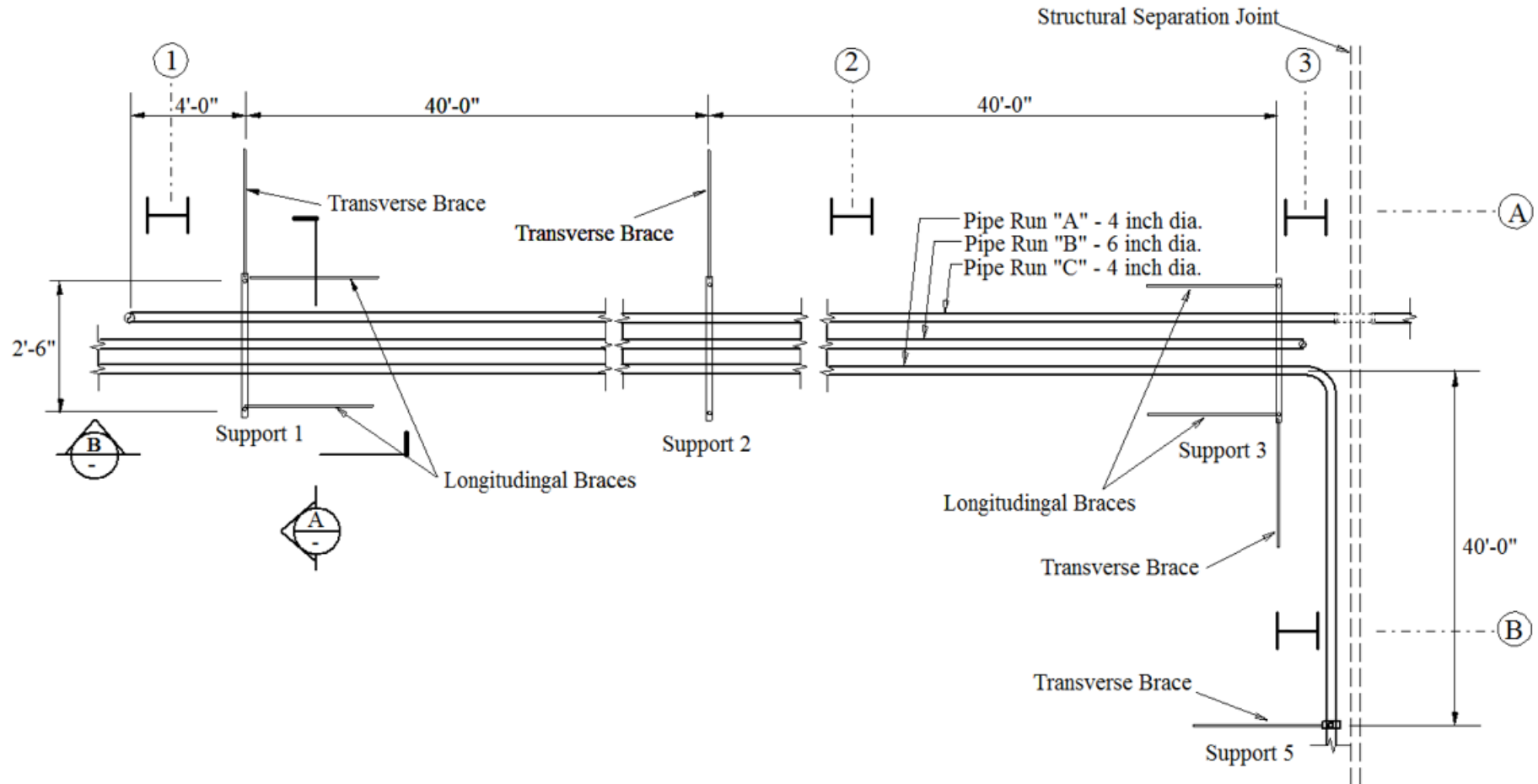

Plan of piping system

Piping System Description

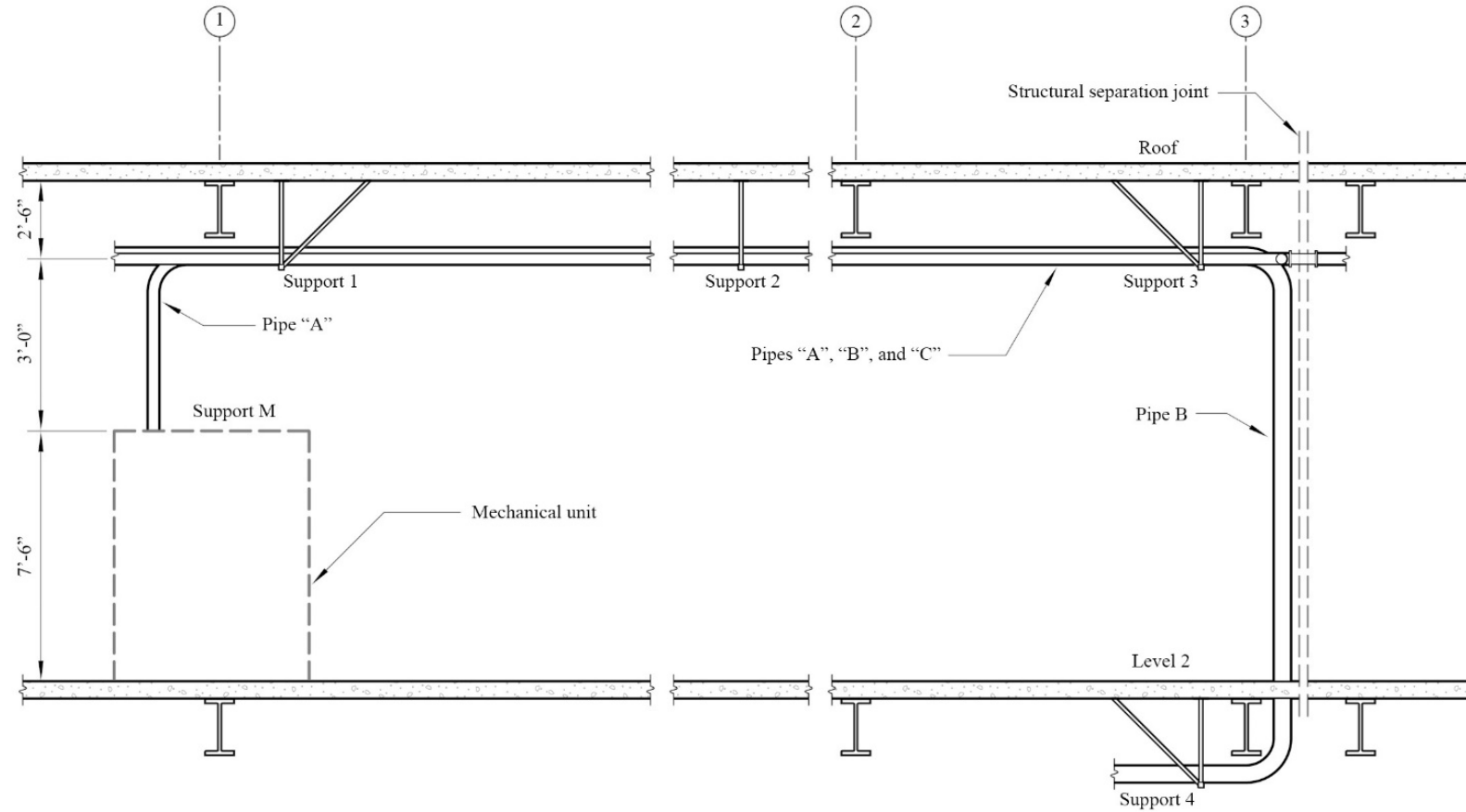

Piping system near column line 'A'

Piping System Description: Bracing

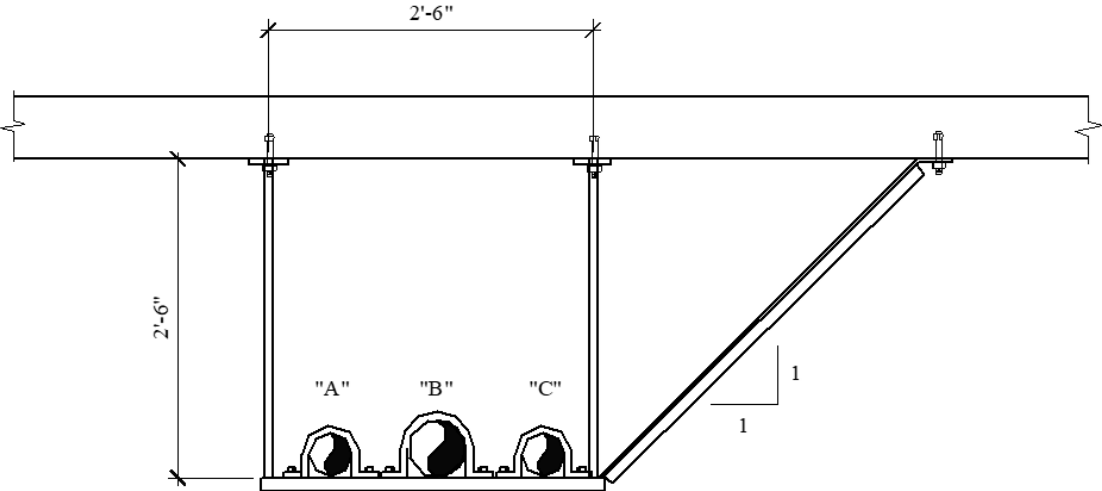

Typical trapeze-type support assembly with transverse bracing

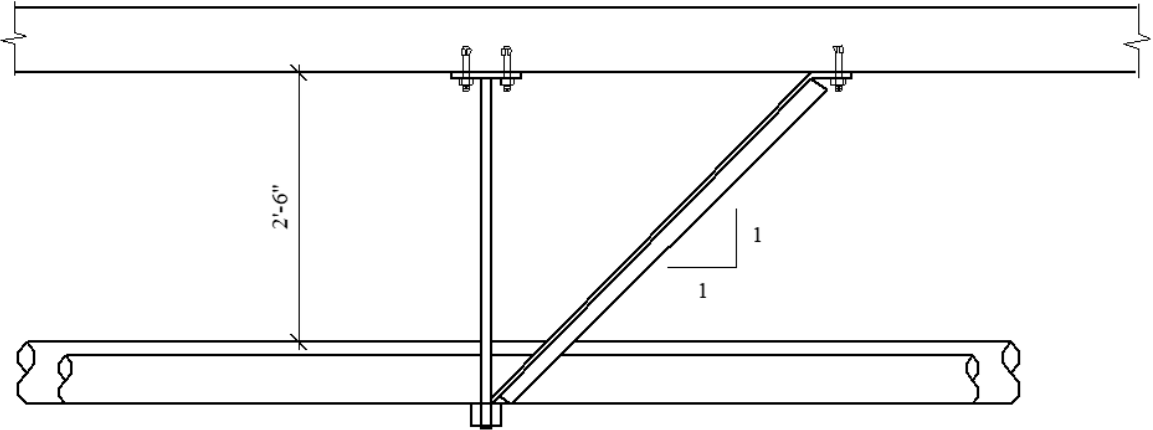

Typical trapeze-type support assembly with longitudinal bracing



Piping System Description: System Configuration

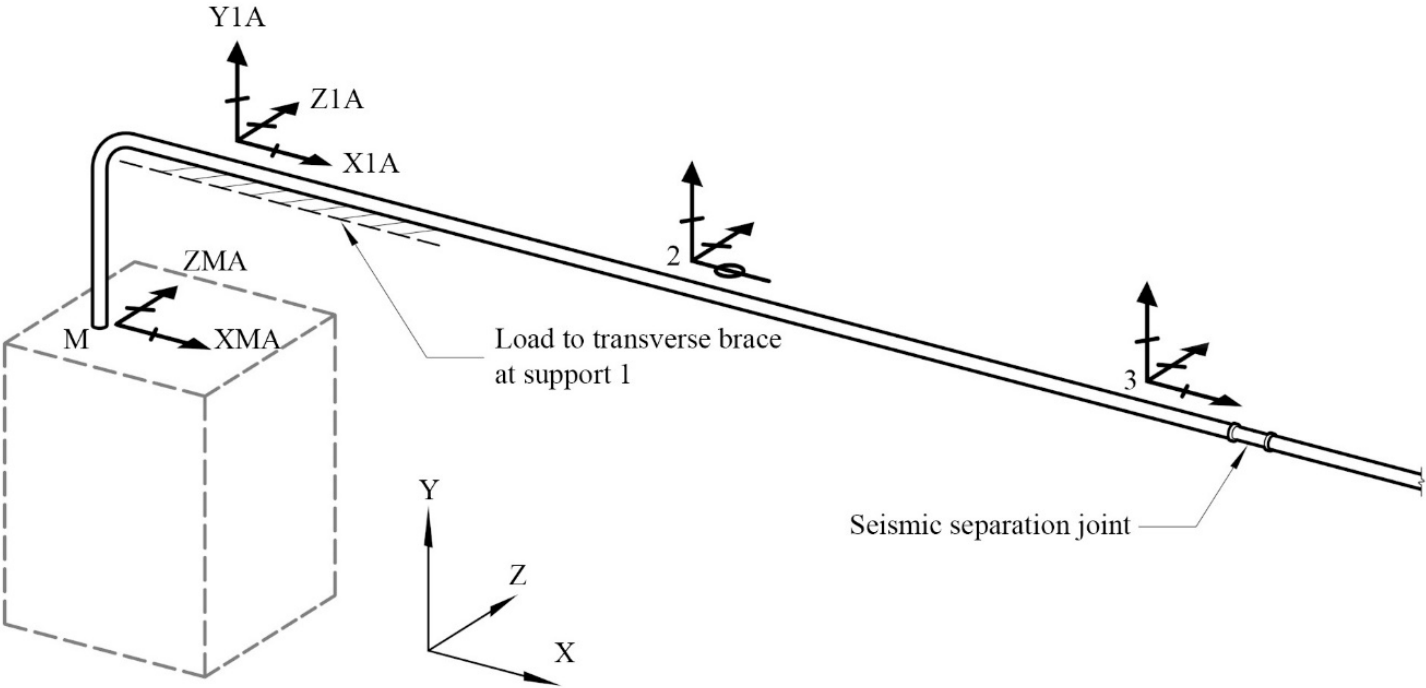

Piping Run “A”: a 4-inch-diameter pipe, which connects to a large mechanical unit at Line 1 supported at the second level. It crosses a seismic separation between adjacent structures at Line 3.



Piping System Description: System Configuration

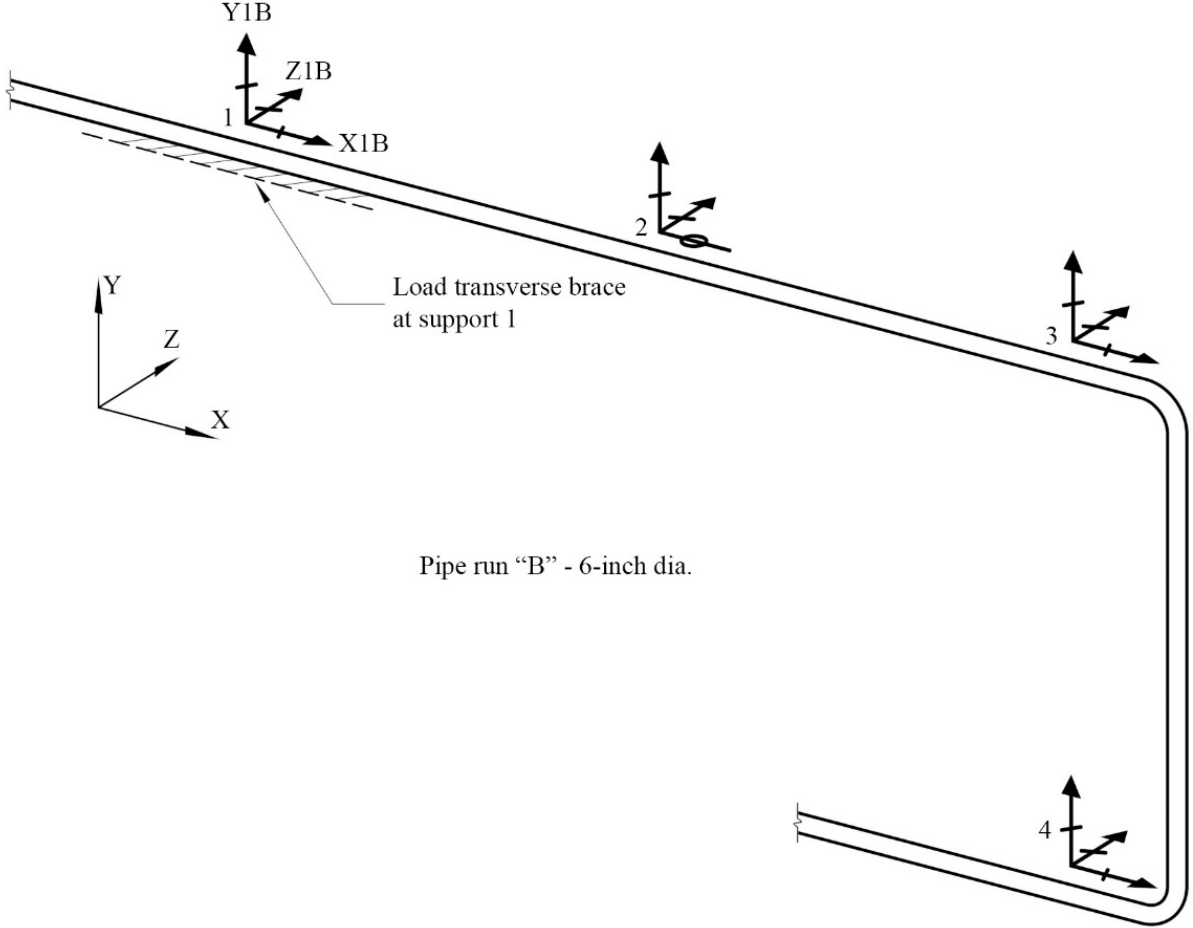

Piping Run "B": a 6-inch-diameter pipe, which has a vertical riser to the second level at Line 3.



Piping System Description: System Configuration

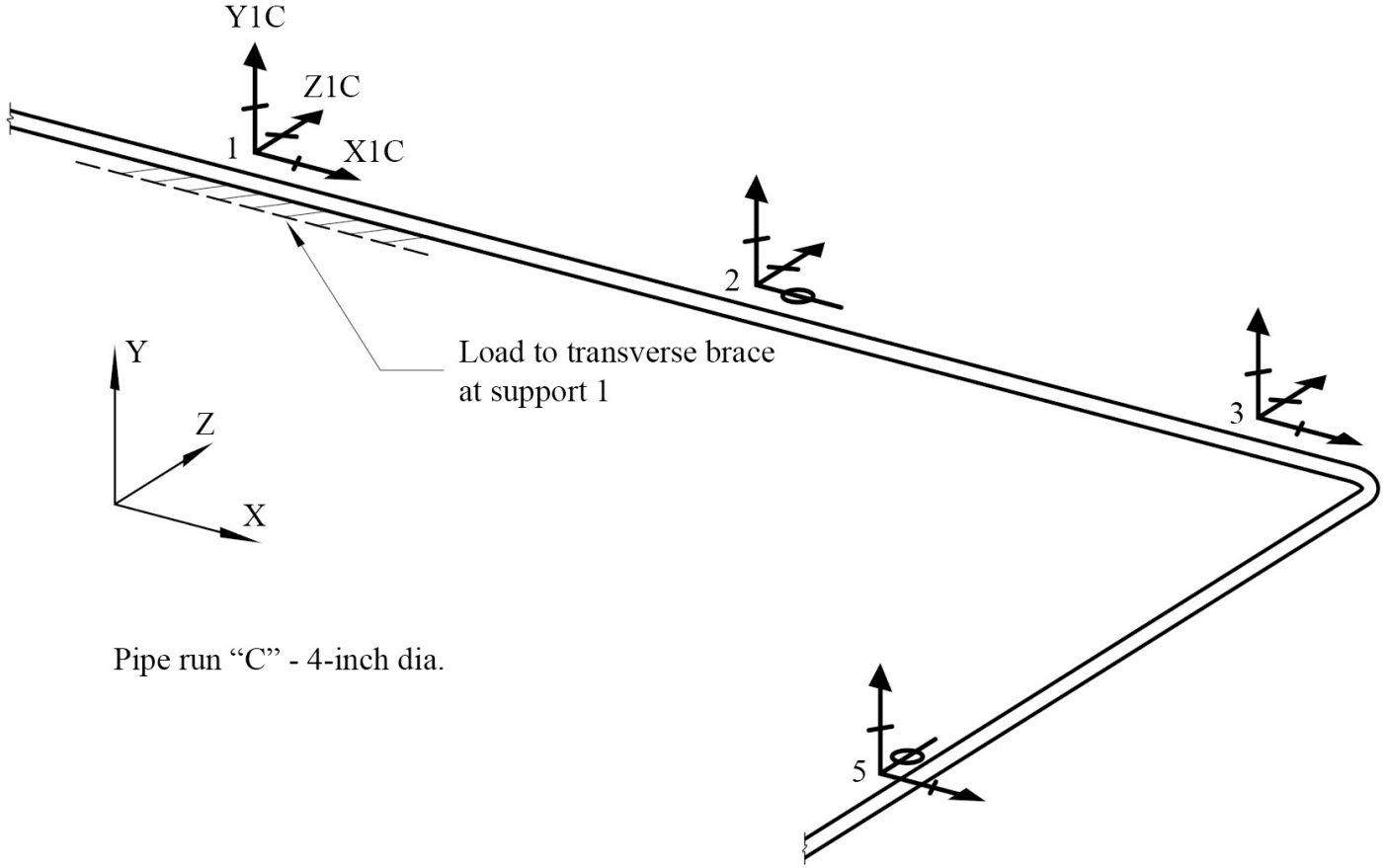

Piping Run "C": a 4-inch-diameter pipe, which turns 90 degrees to parallel Line 3 at Column Line A-3.



FEMA

Building Seismic Safety Council



ASCE/SEI 7-22 Parameters and Coefficients

Coefficients for Mechanical and Electrical components (Table 13.6-1)

- Distribution systems – Piping and tubing not in accordance with ASME B31, including in-line components, constructed of high- or limited-deformability materials, with joints made by threading, bonding, compression couplings, or grooved couplings:
 - $C_{AR} = 2.2$
 - $R_{po} = 2.0$
 - $\Omega_{0p} = 1.75$
- Distribution system supports – hot-rolled steel bracing:
 - $C_{AR} = 1.0$
 - $R_{po} = 1.5$
 - $\Omega_{0p} = 2.0$



ASCE/SEI 7-22 Parameters and Coefficients

- Design coefficients and factors for seismic force-resisting system (Table 12.2-1)
 - Bearing frame system – steel BRBF: $R = 8.0$ and $\Omega_0 = 2.5$
- Short period design spectral acceleration, $S_{DS} = 1.00$
- Seismic Importance Factor, $I_e = 1.5$
- Component Importance Factor, $I_p = 1.5$
- Redundancy factor, $\rho = 1.0$
- Height of attachment at roof, $z = 30$ ft
- Average roof height, $h = 30$ ft
- Story height, $h_{sx} = 15$ ft



Piping and Braces Parameters

- Gravity (non-seismic) support spacing, $L_{grav\ sup} = 10$ ft
- Lateral brace spacing, $L_{lat\ brace} = 40$ ft
- Longitudinal brace spacing, $L_{long\ brace} = 80$ ft
- Length from Support 1 to mechanical unit, $L_{1M} = 9$ ft
- ASTM A53 pipe with threaded connections, $F_y = 35,000$ psi
- System working pressure, $P = 200$ psi
- 4-inch diameter water-filled pipe weight, $D = W_p = 16.4$ plf
- 6-inch diameter water-filled pipe weight, $D = W_p = 31.7$ plf



ASCE/SEI 7-22 Parameters and Coefficients

- Approximate fundamental period of the supporting structure, T_a (Section 12.8.2.1)

$$T_a = C_t h_n^x = (0.03)(30 \text{ ft})^{0.75} = 0.38 \text{ s}$$

- Force amplification factor as a function of height in the structure, H_f

$$a_1 = \frac{1}{T_a} = \frac{1}{0.38 \text{ s}} = 2.63 > 2.5, \text{ use } a_1 = 2.5$$

$$a_2 = [1 - (0.4/T_a)^2] = [1 - (0.4/0.38 \text{ s})^2] = -0.11 < 0, \text{ use } a_2 = 0$$

$$H_f = 1 + a_1 \left(\frac{z}{h}\right) + a_2 \left(\frac{z}{h}\right)^{10} = 1 + 2.5 \left(\frac{30 \text{ ft}}{30 \text{ ft}}\right) + 0 \left(\frac{30 \text{ ft}}{30 \text{ ft}}\right)^{10} = 3.5$$

For supporting structures with $T_a \leq 0.4 \text{ s}$, $a_1 = 2.5$ and $a_2 = 0$.

- Structure ductility reduction factor, R_μ

$$R_\mu = (1.1 R / (I_e \Omega_0))^{1/2} = (1.1(8 / ((1.5)(2.5)))^{1/2} = 1.53 \geq 1.3$$



Applicable Requirements

- Component failure shall not cause failure of an essential architectural, mechanical, or electrical component (Section 13.2.4).
- Seismic attachments shall be bolted, welded, or otherwise positively fastened without considering the frictional resistance produced by the effects of gravity (Section 13.4).
- F_p shall be applied at the component's center of gravity and distributed relative to the component's mass distribution (Section 13.3.1).
- Effects of seismic relative displacements shall be considered in combination with displacements caused by other loads as appropriate (Section 13.3.2) .
- Piping system shall be designed for the seismic forces and D_{pI} (Section 13.6.7).
- Distribution system supports shall be designed for seismic forces and D_{pI} . Distribution systems braced to resist vertical, transverse, and long. seismic loads (Section 13.6.7).



Prescribed Seismic Forces: Piping System Design

- Seismic design force, F_p

$$F_p = 0.4S_{DS}I_pW_p \left[\frac{H_f}{R_\mu} \right] \left[\frac{C_{AR}}{R_{po}} \right] = 0.4(1.0)(1.5)(W_p) \left[\frac{3.5}{1.53} \right] \left[\frac{2.2}{2.0} \right] = 1.508W_p \quad (\text{controlling equation})$$

$$F_{p,max} = 1.6S_{DS}I_pW_p = 1.6(1.0)(1.5)(W_p) = 2.40W_p$$

$$F_{p,min} = 0.3S_{DS}I_pW_p = 3(1.0)(1.5)(W_p) = 0.45W_p$$

- Horizontal seismic load effect, E_h

$$E_h = \rho Q_E = \rho F_p = (1.0)(1,072 \text{ lb}) = 1,072 \text{ lb}$$

- Vertical seismic load effect, E_v

$$E_v = 0.2S_{DS}D = (0.2)(0.474g)(3,000 \text{ lb}) = 284 \text{ lb}$$

- Basic Load Combinations for Strength Design:

$$1.2D + E_v + E_h + L + 0.2S \text{ (Load Combination 6) and } 0.9D - E_v + E_h \text{ (Load Combination 7)}$$



Proportioning and Design: Piping System Design

4-in. diameter pipe (Pipe Runs “A” and “C”)

- Inner diameter, $d_1 = 4.026$ in.
- Outer diameter, $d = 4.5$ in.
- Wall thickness, $t = 0.237$ in.
- Plastic modulus, $Z = 4.31$ in.³
- Moment of inertia, $I = 7.23$ in.⁴

6-in. diameter pipe (Pipe Run “B”)

- Inner diameter, $d_1 = 6.065$ in.
- Outer diameter, $d = 6.625$ in.
- Wall thickness, $t = 0.28$ in.
- Plastic modulus, $Z = 11.28$ in.³
- Moment of inertia, $I = 28.14$ in.⁴



Proportioning and Design: Piping System Design

Gravity and Pressure Loads

- Longitudinal stresses in piping due to pressure and weight

$$f_L = \frac{Pd}{4t} + \frac{M_g}{Z}, \text{ where } M_g = \frac{(D)(L_{grav\ sup})^2}{8} \text{ is the resultant moment due to forces in gravity direction}$$

For 4-inch-diameter pipe

$$M_g = \frac{(16.4 \text{ plf})(10 \text{ ft})^2}{8} = 2,460 \text{ lb-in.}$$

$$f_{L,Dead} = \frac{M_g}{Z} = \frac{2,460 \text{ lb-in.}}{4.31 \text{ in.}^3} = 571 \text{ psi}$$

$$f_{L,Pressure} = \frac{Pd}{4t} = \frac{(200 \text{ psi})(4.5 \text{ in.})}{4(0.237 \text{ in.})} = 949 \text{ psi}$$

For 6-inch-diameter pipe

$$M_g = \frac{(31.7 \text{ plf})(10 \text{ ft})^2}{8} = 4,755 \text{ lb-in.}$$

$$f_{L,Dead} = \frac{M_g}{Z} = \frac{4,755 \text{ lb-in.}}{11.28 \text{ in.}^3} = 422 \text{ psi}$$

$$f_{L,Pressure} = \frac{Pd}{4t} = \frac{(200 \text{ psi})(6.625 \text{ in.})}{4(0.28 \text{ in.})} = 1,183 \text{ psi}$$



Proportioning and Design: Piping System Design

Seismic Loads on Piping Runs “A” and “C” – 4-in-diameter pipe

- Horizontal seismic load effect, E_h , and vertical seismic load effect, E_v

$$F_p = 1.508W_p = 1.508(16.4 \text{ plf}) = 24.7 \text{ lb/ft}$$

$$E_h = \rho Q_E = \rho F_p = (1.0)(24.7 \text{ lb/ft}) = 24.7 \text{ lb/ft}$$

$$E_v = 0.2S_{DS}D = 0.2(1.0)(16.4 \text{ plf}) = 3.28 \text{ lb/ft}$$

- Maximum moment due to horizontal seismic load, M_{Eh} , and associated flexural stress

$$M_{Eh} = \frac{(E_h)(L_{lat \text{ brace}})^2}{8} = \frac{(24.7 \text{ lb/ft})(40 \text{ ft})^2}{8} = 4,946 \text{ lb-ft} = 59,353 \text{ lb-in.}$$

$$f_{bh} = \frac{M_{Eh}}{Z} = \frac{59,353 \text{ lb-in.}}{4.31 \text{ in.}^3} = 13,766 \text{ psi}$$



Proportioning and Design: Piping System Design

Seismic Loads on Piping Runs “A” and “C” – 4-in-diameter pipe (Continued)

- Maximum moment due to vertical seismic load, M_{Ev} , and associated flexural stress

$$M_{Ev} = \frac{(E_v)(L_{grav\ sup})^2}{8} = \frac{(3.28\ \text{plf})(10\ \text{ft})^2}{8} = 41\ \text{lb-ft} = 492\ \text{lb-in.}$$

$$f_{bv} = \frac{M_{Ev}}{Z} = \frac{492\ \text{lb-in.}}{4.31\ \text{in.}^3} = 114\ \text{psi}$$

- Design stress in the pipe, f_u , using Load Combination 6: $1.2D + E_v + E_h + L + 0.2S$

$$f_u = 1.2(f_{L,Dead} + f_{L,Pressure}) + f_{bv} + f_{bh}$$

$$f_u = 1.2(571\ \text{psi} + 949\ \text{psi}) + 114\ \text{psi} + 13,766\ \text{psi} = 15,704\ \text{psi}$$

- Permissible stress check, $f_u < 0.7F_y$, where $0.7F_y = 0.7 \times 35,000\ \text{psi} = 24,500\ \text{psi}$

$$15,704\ \text{psi} < 24,500\ \text{psi} \quad \text{OK}$$



Proportioning and Design: Piping System Design

Seismic Loads on Piping Runs “B” – 6-in-diameter pipe

- Horizontal seismic load effect, E_h , and vertical seismic load effect, E_v

$$F_p = 1.508W_p = 1.508(31.7 \text{ plf}) = 47.8 \text{ lb/ft}$$

$$E_h = \rho Q_E = \rho F_p = (1)(47.8 \text{ lb/ft}) = 47.8 \text{ lb/ft}$$

$$E_v = 0.2S_{DS}D = 0.2(1.0)(31.7 \text{ plf}) = 6.34 \text{ lb/ft}$$

- Maximum moment due to horizontal seismic load, M_{Eh} , and associated flexural stress

$$M_{Eh} = \frac{(E_h)(L_{lat \text{ brace}})^2}{8} = \frac{(47.8 \text{ lb/ft})(40 \text{ ft})^2}{8} = 9,560 \text{ lb-ft} = 114,725 \text{ lb-in.}$$

$$f_{bh} = \frac{M_{Eh}}{Z} = \frac{114,725 \text{ lb-in.}}{11.28 \text{ in.}^3} = 10,171 \text{ psi}$$



Proportioning and Design: Piping System Design

Seismic Loads on Piping Runs “B” – 6-in-diameter pipe (Continued)

- Maximum moment due to vertical seismic load, M_{Ev} , and associated flexural stress

$$M_{Ev} = \frac{(E_v)(L_{grav\ sup})^2}{8} = \frac{(6.34\ \text{plf})(10\ \text{ft})^2}{8} = 79\ \text{lb-ft} = 951\ \text{lb-in.}$$

$$f_{bv} = \frac{M_{Ev}}{Z} = \frac{951\ \text{lb-in.}}{11.28\ \text{in.}^3} = 84\ \text{psi}$$

- Design stress in the pipe, f_u , using Load Combination 6: $1.2D + E_v + E_h + L + 0.2S$

$$f_u = 1.2(f_{L,Dead} + f_{L,Pressure}) + f_{bv} + f_{bh}$$

$$f_u = 1.2(421\ \text{psi} + 1,183\ \text{psi}) + 84\ \text{psi} + 10,171\ \text{psi} = 12,181\ \text{psi}$$

- Permissible stress check, $f_u < 0.7F_y$, where $0.7F_y = 0.7 \times 35,000\ \text{psi} = 24,500\ \text{psi}$

$$12,181\ \text{psi} < 24,500\ \text{psi} \quad \text{OK}$$



Prescribed Seismic Forces: Pipe Supports and Bracing

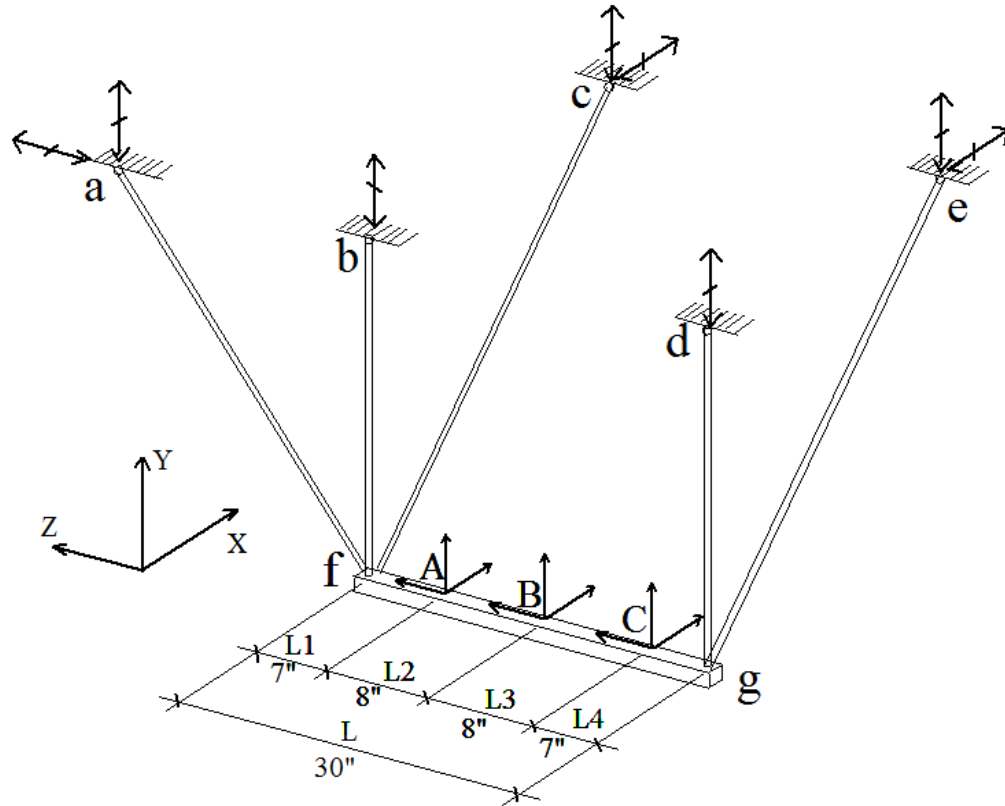

Design demands on piping support assembly

- Design demands are calculated for vertical supports, lateral supports, and anchorage at Support 1.
- The following elements should be designed:
 - Beam f-g
 - Hangers f-b and g-d
 - Transvers brace a-f
 - Longitudinal braces f-c and g-e
 - Connections at a, b, c, d, and e

Prescribed Seismic Forces: Pipe Supports and Bracing

- Seismic design force, F_p

$$F_p = 0.4S_{DS}I_pW_p \left[\frac{H_f}{R_\mu} \right] \left[\frac{C_{AR}}{R_{po}} \right] = 0.4(1.0)(1.5)(W_p) \left[\frac{3.5}{1.53} \right] \left[\frac{1.0}{1.5} \right] = 0.914W_p \quad (\text{controlling equation})$$

$$F_{p,max} = 1.6S_{DS}I_pW_p = 1.6(1.0)(1.5)(W_p) = 2.40W_p$$

$$F_{p,min} = 0.3S_{DS}I_pW_p = 3(1.0)(1.5)(W_p) = 0.45W_p$$

- Horizontal seismic load effect, E_h

$$E_h = \rho Q_E = \rho F_p = (1.0)(0.914W_p) = 0.914W_p$$

- Vertical seismic load effect, E_v

$$E_v = 0.2S_{DS}D$$

- Basic Load Combinations for Strength Design:

$$1.2D + E_v + E_h + L + 0.2S \quad (\text{Load Combination 6}) \quad \text{and} \quad 0.9D - E_v + E_h \quad (\text{Load Combination 7})$$



Proportioning and Design: Pipe Supports and Bracing

Vertical Loads

- For 4-inch diameter pipes

$$\text{Dead load, } P_{v4} = (D)(L_{grav\ sup}) = (16.4\ \text{plf})(10\ \text{ft}) = 164\ \text{lb}$$

$$\text{Vertical seismic load, } P_{Ev4} = 0.2S_{DS}D(L_{grav\ sup}) = 0.2(1.0)(16.4\ \text{plf})(10\ \text{ft}) = 33\ \text{lb}$$

- For 6-inch diameter pipes

$$\text{Dead load, } P_{v6} = (D)(L_{grav\ sup}) = (31.7\ \text{plf})(10\ \text{ft}) = 317\ \text{lb}$$

$$\text{Vertical seismic load, } P_{Ev6} = 0.2S_{DS}D(L_{grav\ sup}) = 0.2(1.0)(31.7\ \text{plf})(10\ \text{ft}) = 63\ \text{lb}$$



Proportioning and Design: Pipe Supports and Bracing

Longitudinal Lateral Loads

- For Piping Run “A”, the total length of pipe tributary to Support 1 is 40 feet (half the distance between longitudinal braces at Supports 1 and 3) plus 9 feet (length of pipe from Support 1 to Support M, the mechanical unit), or 49 feet:

$$P_{X1A} = \rho F_p = \rho(0.914W_p) = (1)(0.914)(16.4 \text{ lb/ft})(49 \text{ ft}) = 734 \text{ lb}$$

- For Piping Runs “B” and “C”, the total length of pipe tributary to Support 1 is approximately 80 feet:

$$P_{X1B} = \rho F_p = \rho(0.914W_p) = (1)(0.914)(31.7 \text{ lb/ft})(80 \text{ ft}) = 2,318 \text{ lb}$$

$$P_{X1C} = \rho F_p = \rho(0.914W_p) = (1)(0.914)(16.4 \text{ lb/ft})(80 \text{ ft}) = 1,199 \text{ lb}$$



Proportioning and Design: Pipe Supports and Bracing

Transverse Lateral Loads

- Pipes are idealized as continuous beams spanning between pinned connections, representing the transverse braces. Reaction at the beam's midspan is calculated as:

$$P_Z = \frac{5}{8} W(L_{left} + L_{right})$$

- For Piping Run "A", we analyze the transverse Support 1, which is adjacent to the mechanical unit. The total length between the support and the unit is $L_{1M} = 9$ ft

$$P_{Z1A} = \left(\frac{5}{8}\right) W(L_{left} + L_{right}) = \left(\frac{5}{8}\right) (\rho F_p)(L_{1M} + L_{lat\ brace})$$

$$P_{Z1A} = \left(\frac{5}{8}\right) (1)(0.914) \left(16.4 \frac{\text{lb}}{\text{ft}}\right) (9 \text{ ft} + 40 \text{ ft}) = 459 \text{ lb}$$



Proportioning and Design: Pipe Supports and Bracing

Transverse Lateral Loads (Continued)

- For Piping Runs “B” and “C”, we assume that 5/8 of the total length of pipe on each side of Support 1 is laterally braced at Support 1

$$P_{Z1B} = \left(\frac{5}{8}\right) W(L_{left} + L_{right}) = \left(\frac{5}{8}\right) (\rho F_p)((2)(L_{lat\ brace}))$$

$$P_{Z1B} = \left(\frac{5}{8}\right) (1)(0.914) \left(31.7 \frac{\text{lb}}{\text{ft}}\right) ((2)(40 \text{ ft})) = 1,449 \text{ lb}$$

$$P_{Z1C} = \left(\frac{5}{8}\right) W(L_{left} + L_{right}) = \left(\frac{5}{8}\right) (\rho F_p)((2)(L_{lat\ brace}))$$

$$P_{Z1C} = \left(\frac{5}{8}\right) (1)(0.914) \left(16.4 \frac{\text{lb}}{\text{ft}}\right) ((2)(40 \text{ ft})) = 749 \text{ lb}$$



Prescribed Seismic Displacements

Design for Displacements within Structures

- The building is designed for a maximum allowable story drift of 1.5% per floor.

$$\text{Allowable story drift, } \Delta_a = 0.015h_{sx} = 0.015(15 \text{ ft})(12 \text{ in./ft}) = 2.7 \text{ in.}$$

- Seismic relative displacements, D_{pI}

$$D_{pI} = D_p I_e = (2.7 \text{ in.})(1.5) = 4.05 \text{ in.}$$

- Drift can be accommodated by providing a flexible coupling or through bending in the pipe.
- Piping Run “A” connects to a large mechanical unit at Line 1 supported at Level 2. The entire story drift must be accommodated in the 5 feet piping drop.

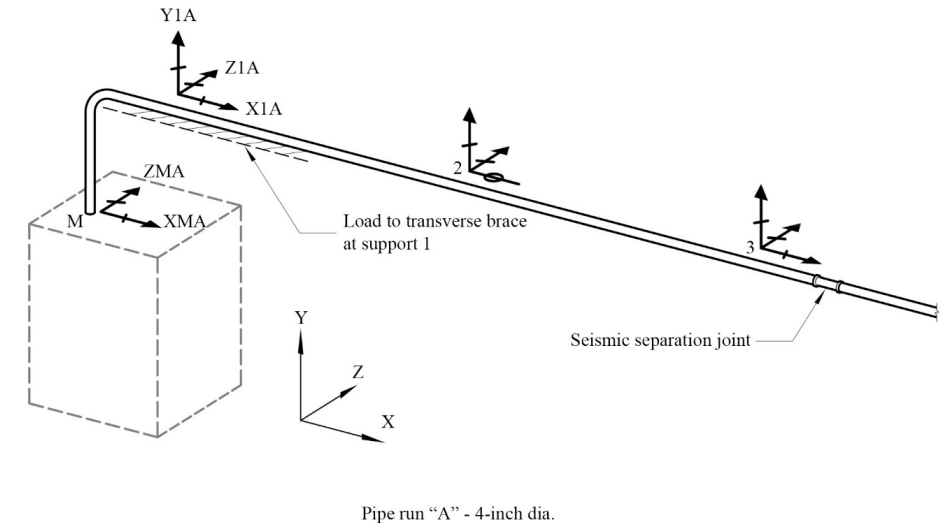

Prescribed Seismic Displacements

Design for Displacements within Structures (Continued)

- For a 4-inch-diameter pipe, assuming the pipe is fixed against rotation at both ends, the shear and moments required to deflect the pipe 4.05 in. are:

$$V = \frac{12EID_{pI}}{L^3} = \frac{12(29,000,000 \text{ psi})(7.23 \text{ in.}^4)(4.05 \text{ in.})}{((5 \text{ ft})(12 \text{ in./ft}))^3} = 47,193 \text{ lb}$$

$$M = VL = (47,176 \text{ lb})(5 \text{ ft})(12 \text{ in./ft}) = 2,831,563 \text{ lb-in.}$$

- The stress in the pipe displaced D_{pI} is:

$$f_b = \frac{M}{Z} = \frac{2,831,563 \text{ lb-in.}}{4.31 \text{ in.}^3} = 656,750 \text{ psi}$$

- The permissible stress is $0.7F_y = 0.7(35,000 \text{ psi}) = 24,500 \text{ psi}$.
- The demand far exceeds the capacity of the pipe. Therefore, either a flexible coupling or a loop piping layout is required to accommodate the story drift.



Prescribed Seismic Displacements

Design for Displacements within Structures (Continued)

- Piping Run “B” drops from the roof to Level 2 at Line 3. The drift is the same and it can be accommodated over the full story height of 15 feet.

$$V = \frac{12EID_{pI}}{L^3} = \frac{12(29,000,000 \text{ psi})(28.14 \text{ in.}^4)(4.05 \text{ in.})}{((15 \text{ ft})(12 \text{ in./ft}))^3} = 6,801 \text{ lb}$$

$$M = VL = (6,800 \text{ lb})(15 \text{ ft})(12 \text{ in./ft})/2 = 612,092 \text{ lb-in.}$$

- The stress in the pipe displaced D_{pI} is:

$$f_b = \frac{M}{Z} = \frac{612,092 \text{ lb-in.}}{11.28 \text{ in.}^3} = 54,264 \text{ psi}$$

- The permissible stress is $0.7F_y = 0.7(35,000 \text{ psi}) = 24,500 \text{ psi}$.
- The demand exceeds the permissible stress in the pipe, but not by a wide margin.

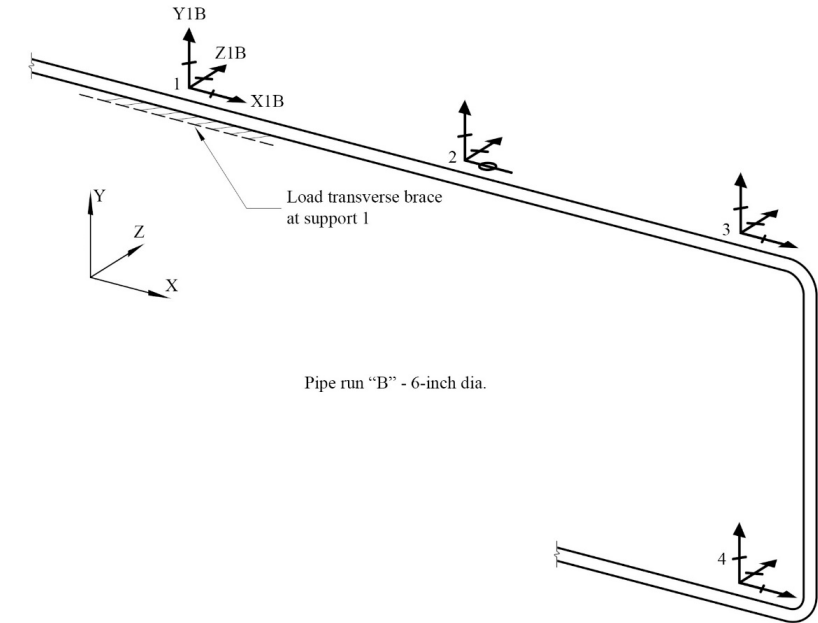

Prescribed Seismic Displacements

Design for Displacements Between Structures

- At the roof, Piping Run “A” crosses a seismic separation between adjacent two-story structures. The story heights are 15 ft and buildings are designed for $\Delta_a = 0.015h_{sx}$.

Deflections of the buildings:

$$\delta_{XA} = \delta_{XB} = (2)0.015h_{sx} = (2)(0.015)(15 \text{ ft})(12 \text{ in./ft}) = 5.4 \text{ in.}$$

Displacement demand:

$$D_{pmax} = |\delta_{XA}| + |\delta_{XB}| = |5.4 \text{ in.}| + |5.4 \text{ in.}| = 10.8 \text{ in.}$$

Seismic relative displacements:

$$D_{pI} = D_p I_e = (10.8 \text{ in.})(1.5) = 16.2 \text{ in.}$$

- The seismic separation joint must accommodate movement perpendicular and parallel to the pipe. Assuming an 18-inch joint, the joint could vary from 8.1 in. to 32.4 in.



Questions?



FEMA



Building Seismic
Safety Council



Elevated Vessel Seismic Design

- Vessel support and attachments
- Supporting frame



FEMA



Building Seismic
Safety Council



Elevated Vessel Description

Example Summary

- **Nonstructural components:**
Mechanical and electrical – pressure vessel not supported on skirts
- **Building seismic force-resisting system:** Special reinforced concrete shear walls
- **Equipment support:** Equipment support structures and platforms –
Seismic Force-Resisting Systems with $R > 3$
- **Occupancy:** Storage
- **Risk Category:** II
- **Component Importance Factor:** $I_p = 1.0$
- **Number of stories:** 3
- $S_{DS} = 1.20$
- $S_1 = 0.65$

- Vessel supported by an OCBF platform with tension-only rods as braces.
- The vessel contains a non-hazardous compressed non-flammable gas.
- The weight of the vessel is less than 5% the total weight of the building structure, which is below the 20% threshold where ASCE/SEI 7-22 requires it be designed as a nonbuilding structure per Chapter 15.



FEMA

 Building Seismic
Safety Council



Elevated Vessel Description

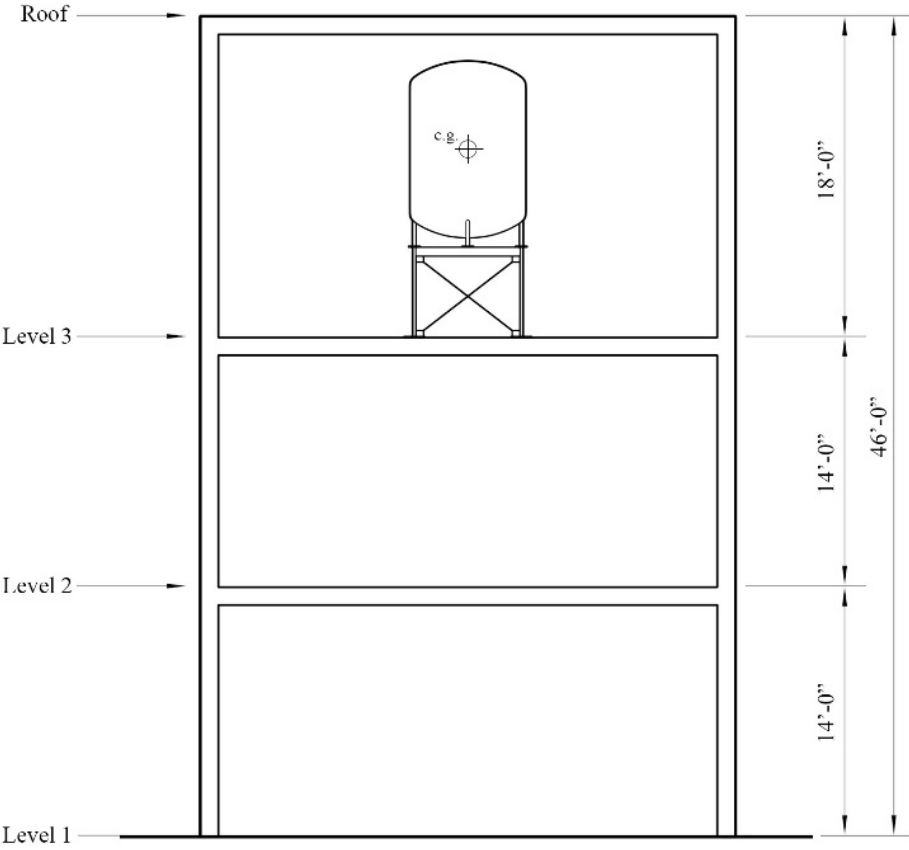

Elevated vessel – section

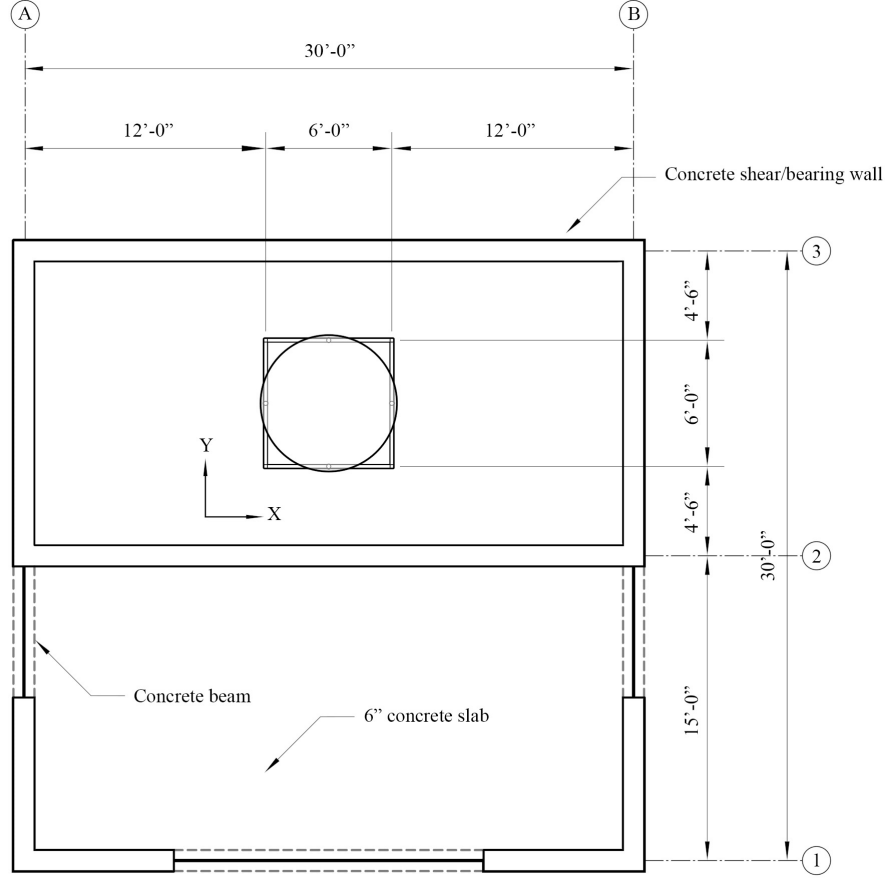

Elevated vessel – Level 3 plan



FEMA

Building Seismic Safety Council



ASCE/SEI 7-22 Parameters and Coefficients

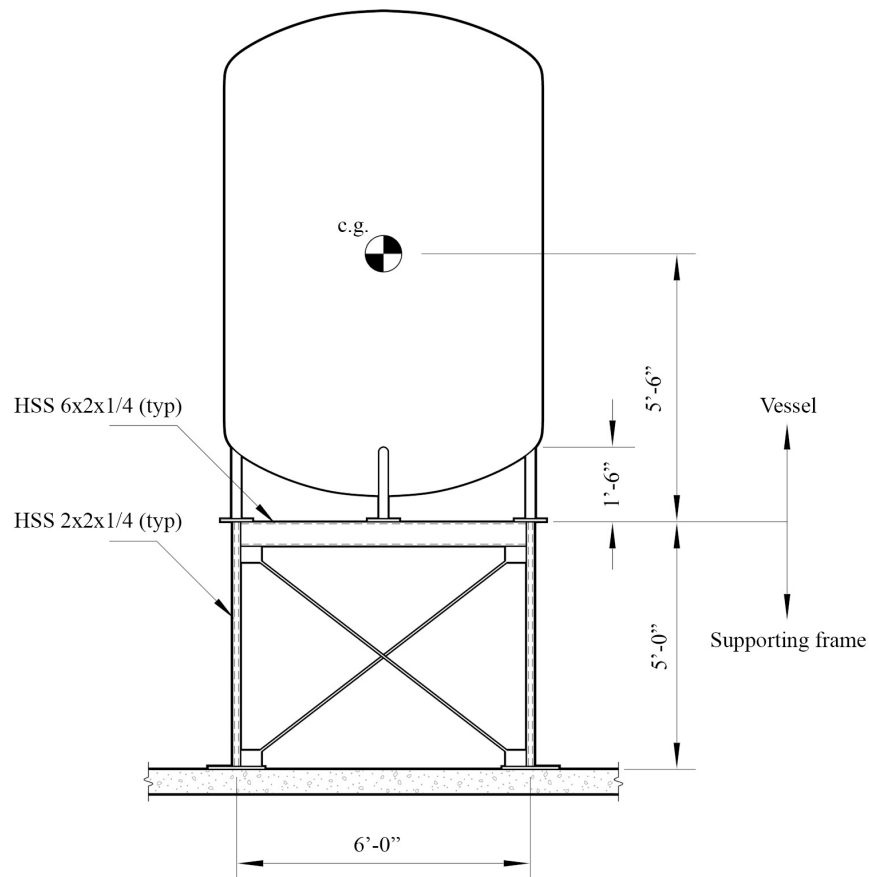

Changes in ASCE/SEI 7-22

ASCE/SEI 7-16 required the nonstructural components and supporting structure to be designed with the same seismic design forces, F_p , regardless of their interaction, and the force was based on the component properties. A platform supporting a pressure vessel would be designed for pressure vessel forces regardless of whether the platform structure was made of concrete, steel braced frames, or steel moment frames.

In ASCE/SEI 7-22, the concept of an equipment support structure or platform has been introduced and defined. Definitions are given in Section 11.2 and properties have been added to Table 13.6-1. Section 13.6.4.6 has been added to ASCE/SEI 7-22 to require that the support structures and platforms be designed in accordance with those properties. This permits a more accurate determination of forces that more realistically reflect the differences in dynamic properties and ductilities between the component and the support structure or platform.

Elevated Vessel Description

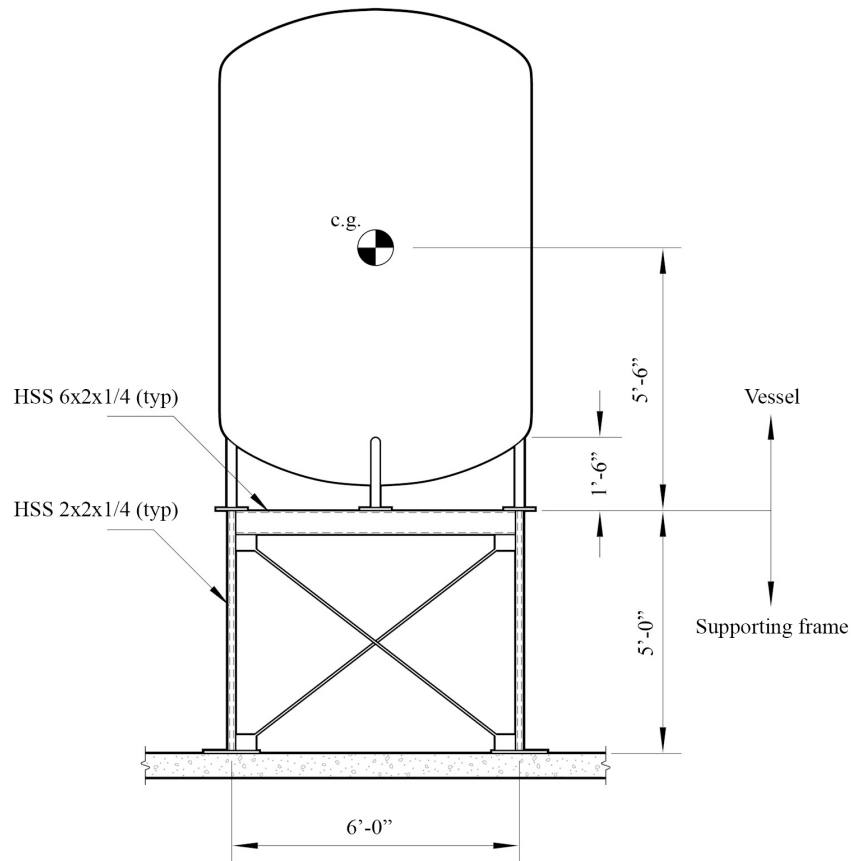

Elevated vessel – supporting frame system

- Section 13.6.4.6 requires the engineers to select the seismic force-resisting system listed in Chapter 12 or Chapter 15 for equipment support structures and platforms.
- C_{AR} for the supported component cannot be less than that for the equipment support structure.
- The reactions applied by the component to the support structure can either stay the same or are effectively scaled down using a two-stage analysis approach.

ASCE/SEI 7-22 Parameters and Coefficients

Coefficients for Mechanical and Electrical Components (Table 13.6-1)

- Mechanical and electrical components – Engines, turbines, pumps, compressors, and pressure vessels not supported on skirts and not within the scope of Chapter 15:
 - $C_{AR} = 1.0$ 1.4
 - $R_{po} = 1.5$
 - $\Omega_{op} = 2.0$
- Equipment support structures and platforms – Seismic Force-Resisting Systems with $R > 3$ (Building frame system – steel ordinary concentrically braced frame, $R=6$ per Table 12.2-1):
 - $C_{AR} = 1.4$
 - $R_{po} = 1.5$
 - $\Omega_{op} = 2.0$

New concept: Per Section 13.3.1.3, C_{AR} for the vessel shall not be less than C_{AR} used for equipment support structure or platform itself.



ASCE/SEI 7-22 Parameters and Coefficients

- Design coefficients and factors for seismic force-resisting system (Table 12.2-1)
 - Bearing wall system – special reinforced concrete shear walls: $R = 5.0$ and $\Omega_0 = 2.5$
- Short period design spectral acceleration, $S_{DS} = 1.20$
- Seismic Importance Factor, $I_e = 1.0$
- Component Importance Factor, $I_p = 1.0$
- Redundancy factor, $\rho = 1.0$
- Height of attachment at roof, $z = 28$ ft
- Average roof height, $h = 46$ ft



FEMA

 Building Seismic
Safety Council



ASCE/SEI 7-22 Parameters and Steel Material Properties

- Vessel and legs weight, $D_{ves} = W_{p,ves} = 5,000$ lb
- Supporting frame weight, $D_{sup} = W_{p,sup} = 1,000$ lb
- Vessel leg length, $L_{leg} = 18$ in.

Steel material properties

- HSS sections: ASTM A500 Grade B, $F_y = 46,000$ psi, $F_u = 58,000$ psi
- Bars and Plates: ASTM A36, $F_y = 36,000$ psi, $F_u = 58,000$ psi
- Pipes: ASTM A53 Grade B, $F_y = 35,000$ psi, $F_u = 60,000$ psi
- Bolts and threaded rods: ASTM A307



ASCE/SEI 7-22 Parameters and Coefficients

- Approximate fundamental period of the supporting structure, T_a (Section 12.8.2.1)

$$T_a = C_t h_n^x = (0.02)(46 \text{ ft})^{0.75} = 0.353 \text{ s}$$

- Force amplification factor as a function of height in the structure, H_f

$$a_1 = \frac{1}{T_a} = \frac{1}{0.353 \text{ s}} = 2.83 > 2.5, \text{ use } a_1 = 2.5$$

$$a_2 = [1 - (0.4/T_a)^2] = [1 - (0.4/0.353 \text{ s})^2] = -0.28 < 0, \text{ use } a_2 = 0$$

$$H_f = 1 + a_1 \left(\frac{z}{h}\right) + a_2 \left(\frac{z}{h}\right)^{10} = 1 + 2.5 \left(\frac{28 \text{ ft}}{46 \text{ ft}}\right) + 0 \left(\frac{28 \text{ ft}}{46 \text{ ft}}\right)^{10} = 2.52$$

For supporting structures with $T_a \leq 0.4 \text{ s}$, $a_1 = 2.5$ and $a_2 = 0$.

- Structure ductility reduction factor, R_μ

$$R_\mu = (1.1 R / (I_e \Omega_0))^{1/2} = (1.1(5 / ((1)(2.5)))^{1/2} = 1.48 \geq 1.3$$



Applicable Requirements

- Component failure shall not cause failure of an essential architectural, mechanical, or electrical component (Section 13.2.4).
- Seismic attachments shall be bolted, welded, or otherwise positively fastened without considering the frictional resistance produced by the effects of gravity (Section 13.4).
- F_p shall be applied at the component's center of gravity and distributed relative to the component's mass distribution (Section 13.3.1).
- Effects of seismic relative displacements shall be considered in combination with displacements caused by other loads as appropriate (Section 13.3.2).
- Local elements of the structure, including connections, shall be designed and constructed for the component forces where they control the design of the elements or their connections (Section 13.4).



Applicable Requirements (Continued)

- Attachments to concrete or masonry shall be designed to resist the seismic load effects including overstrength; Ω_0 shall be taken as Ω_{0p} (Section 13.4.2).
- The equipment support structures and platforms shall be designed for F_p . The seismic force-resisting system for the equipment support structures and platforms shall conform to one of the types indicated in Table 12.2-1 or Table 15.4-1 and abide by the system limitations noted in the tables (Section 13.6.4.6).



FEMA



Building Seismic
Safety Council



Prescribed Seismic Forces: Vessel Support and Attachments

- Vessel and legs weight, $W_{p,ves} = D_{ves} = 5,000$ lb
- Seismic design force, F_p

$$F_p = 0.4S_{DS}I_pW_p \left[\frac{H_f}{R_\mu} \right] \left[\frac{C_{AR}}{R_{po}} \right] = 0.4(1.2)(1.0)(W_p) \left[\frac{2.52}{1.48} \right] \left[\frac{1.4}{1.5} \right] = 0.762W_p \quad (\text{controlling equation})$$

$$F_{p,max} = 1.6S_{DS}I_pW_p = 1.6(1.2)(1.0)(W_p) = 1.92W_p$$

$$F_{p,min} = 0.3S_{DS}I_pW_p = 0.3(1.2)(1.0)(W_p) = 0.360W_p$$

$$F_{p,ves} = 0.762W_p = 0.762(5,000 \text{ lb}) = 3,808 \text{ lb} \quad (\text{controlling seismic design force})$$



Prescribed Seismic Forces: Vessel Support and Attachments

- Horizontal seismic load effect, E_h

$$Q_E = F_p = 3,808 \text{ lb}$$

$$E_{h,ves} = \rho Q_E = (1.0)(3,808 \text{ lb}) = 3,808 \text{ lb}$$

- Vertical seismic load effect, E_v

$$E_{v,ves} = 0.2S_{DS}D = (0.2)(1.2g)(5,000 \text{ lb}) = 1,200 \text{ lb}$$

- Basic Load Combinations for Strength Design to determine the design member and connection forces to be used in conjunction with seismic loads:

$$1.2D + E_v + E_h + L + 0.2S \quad (\text{Load Combination 6})$$

$$0.9D - E_v + E_h \quad (\text{Load Combination 7})$$

For nonstructural components, the terms L and S are typically zero.



Proportioning and Design: Vessel Support and Attachments

- Components to be designed
 - Legs supporting the vessel
 - Connection between the legs and vessel shell
 - Base plates and welds attaching them to legs
 - Bolts connecting base plates to supporting frame

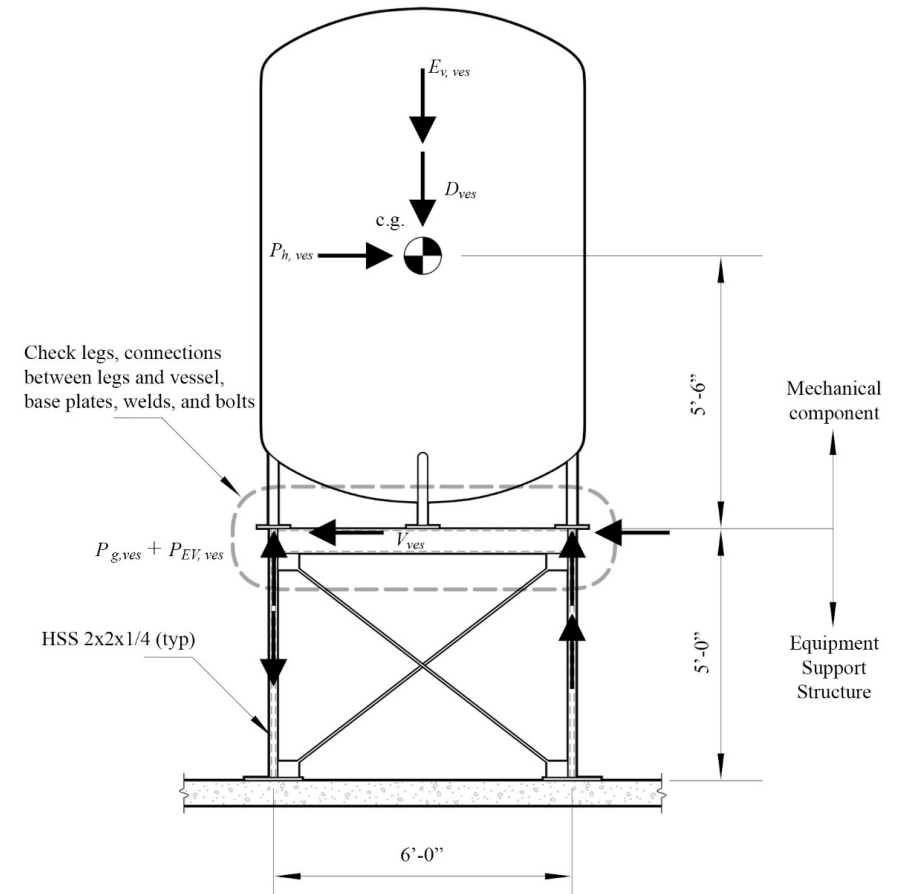

Free body diagram for vessel support and attachments design

Proportioning and Design: Vessel Support and Attachments

- Vessel vertical load in each leg due to dead load, $P_{g,ves}$

$$P_{g,ves} = \frac{D_{ves}}{4 \text{ legs}} = \frac{5,000 \text{ lb}}{4 \text{ legs}} = 1,250 \text{ lb/leg}$$

- Vessel vertical load in each leg due to vertical seismic load effect, $P_{Ev,ves}$

$$P_{Ev,ves} = \frac{E_{v,ves}}{4 \text{ legs}} = \frac{1,200 \text{ lb}}{4 \text{ legs}} = 300 \text{ lb/leg}$$

- Vessel shear force in each leg due to the horizontal seismic load effect, V_{ves}

$$V_{ves} = \frac{E_{h,ves}}{4 \text{ legs}} = \frac{3,808 \text{ lb}}{4 \text{ legs}} = 952 \text{ lb/leg}$$

- Overturning moment at the bottom of leg base plates, height of 5.5 feet

$$M = (5.5 \text{ ft})(E_{h,ves}) = (5.5 \text{ ft})(3,808 \text{ lb}) = 20,946 \text{ lb-ft}$$



Proportioning and Design: Vessel Support and Attachments

- F_p shall be applied independently in at least two orthogonal horizontal directions.
- For vertically cantilevered systems, the lateral force also shall be assumed to act in any horizontal direction.
- In this example, the layout of the vessel legs is symmetric, and there are two horizontal directions of interest, separated by 45 degrees.

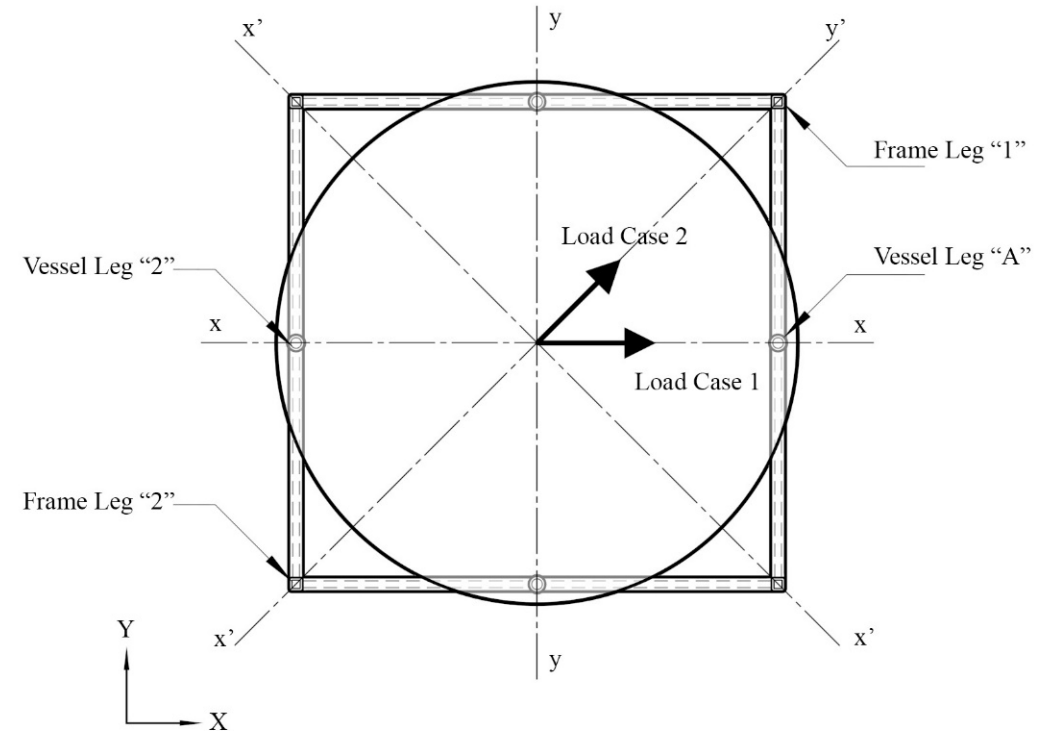

Elevated vessel support load cases

Proportioning and Design: Vessel Support and Attachments

Load Case 1 – Overturning moment about y-y axis

- Overturning moment is resisted by two legs along the x-x axis (one in tension and other in compression). The vessel rotates about the legs on the y-y axis.
- Maximum tension and compression loads in each leg, where the distance between Legs A and C is $d = 6$ ft:

$$P_{Eh_{y-y}} = \frac{M}{d} = \frac{20,946 \text{ lb-ft}}{6 \text{ ft}} = 3,491 \text{ lb}$$

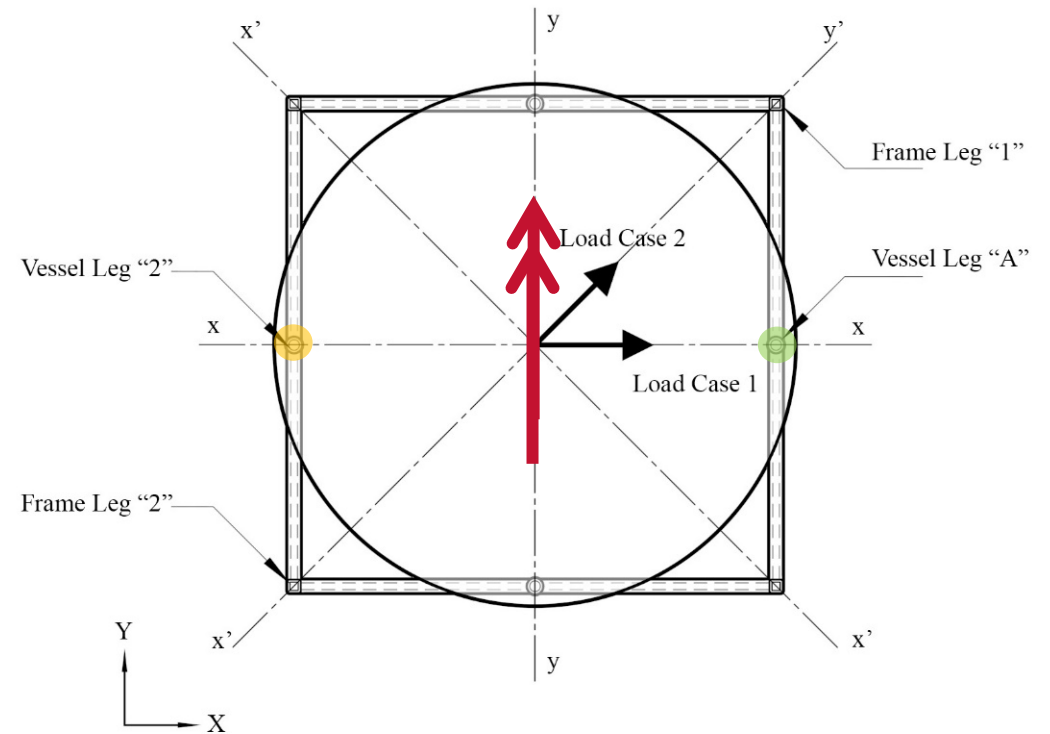

Elevated vessel support load cases

Proportioning and Design: Vessel Support and Attachments

Load Case 2 – Overturning moment about x'-x' axis

- Overturning moment is resisted by four legs (two in tension and two in compression). The vessel rotates about the legs on the x'-x' axis.
- Maximum tension and compression loads in each leg, where the distance between Legs A and C is $d/\sqrt{2}=4.24$ ft:

$$P_{Eh_{x'-x'}} = \frac{M}{2(d/\sqrt{2})} = \frac{20,946 \text{ lb-ft}}{2(4.24 \text{ ft})} = 2,469 \text{ lb}$$

Load Case 1 governs the vessel leg design

$$P_{Eh,ves} = P_{Eh_{y-y}} = 3,491 \text{ lb}$$

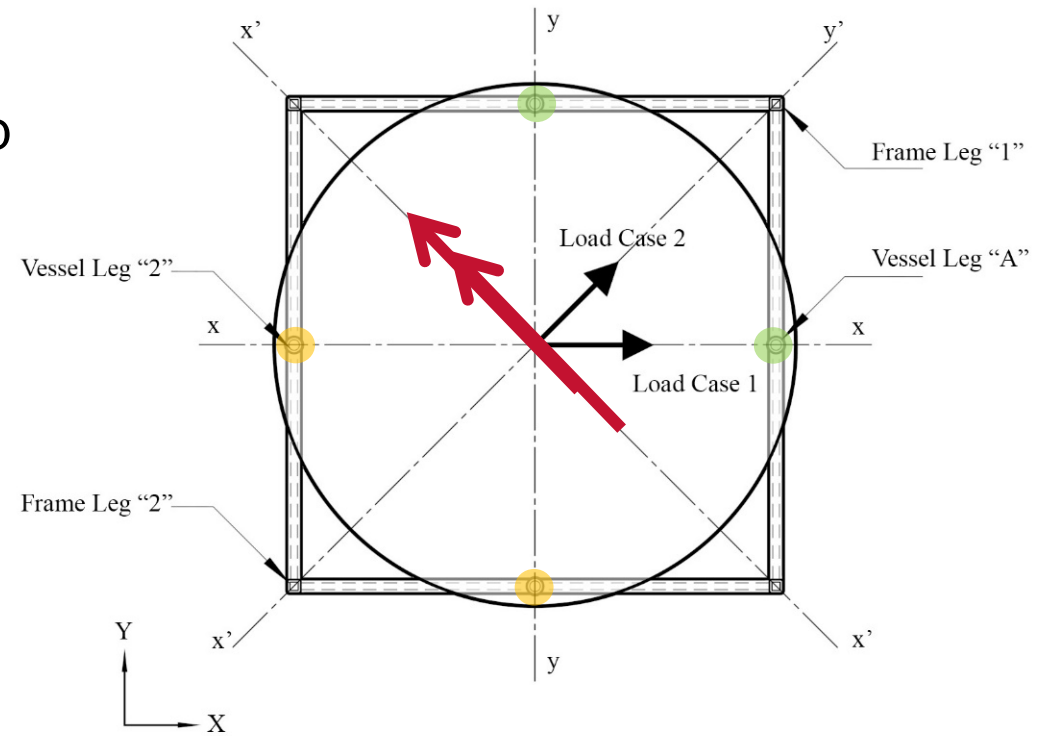

Elevated vessel support load cases

Proportioning and Design: Vessel Support and Attachments

- The design compression loads on the vessel legs is controlled by Load Combination 6:

$$1.2D + E_v + E_h + L + 0.2S$$

$$C_u = 1.2(P_{g,ves}) + P_{Ev,ves} + P_{Eh,ves} = 1.2(1,250 \text{ lb}) + 300 \text{ lb} + 3,491 \text{ lb} = 5,291 \text{ lb}$$

- The design tension load on the vessel legs is controlled by Load Combination 7:

$$0.9D - E_v + E_h$$

$$T_u = 0.9(P_{g,ves}) - P_{Ev,ves} + P_{Eh,ves} = 0.9(1,250 \text{ lb}) - 300 \text{ lb} - 3,491 \text{ lb} = -2,666 \text{ lb (tension)}$$

- The vessel legs shall be designed for the following shear force:

$$V_u = V_{ves} = 952 \text{ lb}$$



Proportioning and Design: Vessel Support and Attachments

Vessel Leg Design

- Section properties of the vessel leg: $A = 1.02 \text{ in.}^2$ and $Z = 0.713 \text{ in.}^3$
- Maximum axial compressive stress in the leg:

$$f_a = \frac{C_u}{A} = \frac{5,291 \text{ lb}}{1.02 \text{ in.}^2} = 5,291 \text{ psi}$$

- Moment and bending stress in the leg, assuming pinned-fixed condition at connections:

$$M_u = (V_u)(L_{leg}) = (952 \text{ lb})(18 \text{ in.}) = 17,138 \text{ lb-in.}$$

$$f_b = \frac{M_u}{Z} = \frac{17,138 \text{ lb-in.}}{0.713 \text{ in.}^3} = 24,036 \text{ psi}$$

- Permissible compressive strength, and bending strength: $F_a = F_{bw} = 31,500 \text{ psi}$
- Combined loading:

$$\left| \frac{f_a}{F_a} + \frac{f_b}{F_{bw}} \right| = \left| \frac{5,291 \text{ psi}}{31,500 \text{ psi}} + \frac{24,036 \text{ psi}}{31,500 \text{ psi}} \right| = 0.93 \leq 1.0 \rightarrow \text{OK}$$



Proportioning and Design: Vessel Support and Attachments

Connections of the Vessel Leg

- The design of this connection involves checking the
 - Weld between the pipe leg and the base plate
 - Base plate
 - Bolts to the supporting frame
- Maximum compression and tension:
 $C_u = 5,291 \text{ lb}$ and $T_u = -2,666 \text{ lb}$ (tension)
- Design shear in each leg:
 $V_u = 952 \text{ lb}$

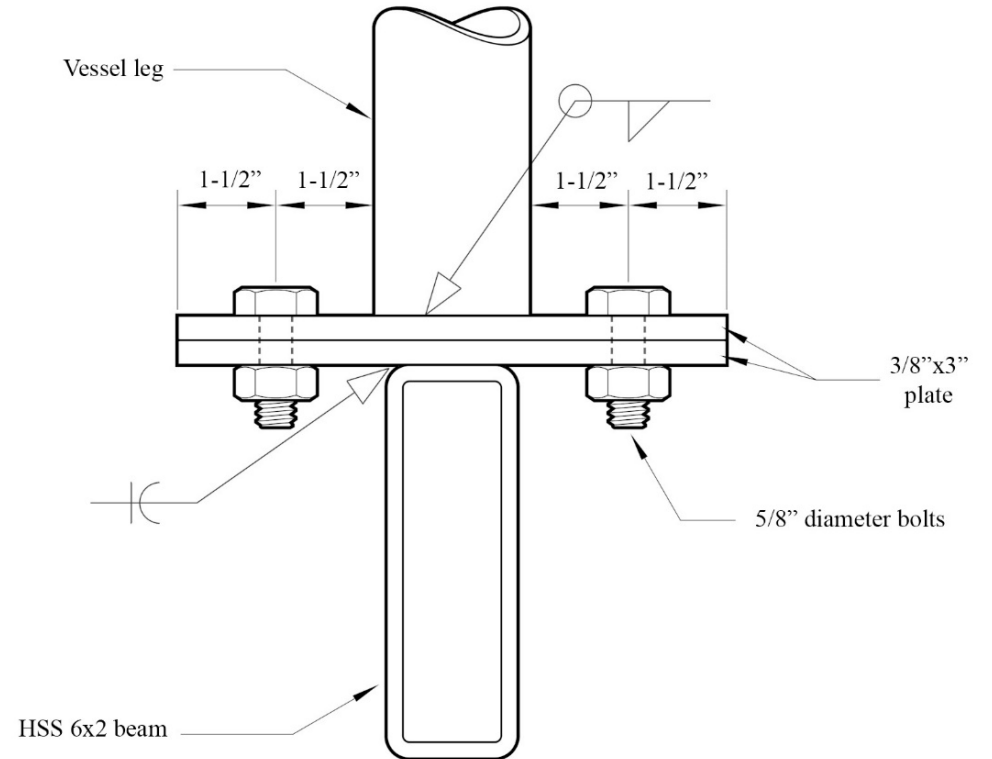

Elevated vessel leg connection

Proportioning and Design: Vessel Support and Attachments

Connections of the Vessel Leg – Bolts

- Each vessel leg connection has two bolts, thus, the connection demand is divided by two
- Maximum tension in each bolt:

$$T_{u,bolt} = \frac{T_u}{2 \text{ bolts}} = \frac{-2,666 \text{ lb}}{2 \text{ bolts}} = -1,333 \text{ lb/bolt}$$

- Maximum shear per bolt:

$$V_{u,bolt} = \frac{V_u}{2 \text{ bolts}} = \frac{952 \text{ lb}}{2 \text{ bolts}} = 476 \text{ lb/bolt}$$

- Available tensile and shear strengths of the of 5/8-inch-diameter ASTM A307 bolts:

$$\phi r_n = 10,400 \text{ lb (tension) and } \phi_v r_n = 5,520 \text{ lb (shear)}$$

- Bolts are adequate, $\phi r_n > T_{u,bolt}$ and $\phi_v r_n > V_{u,bolt}$ **OK**



Proportioning and Design: Vessel Support and Attachments

Connections of the Vessel Leg – Connection Plates

- Connection plates are 3/8 inch thick and 3 inches wide. The plastic section modulus is:

$$Z = \frac{bd^2}{4} = \frac{(3 \text{ in.})(0.375 \text{ in.})^2}{4} = 0.1055 \text{ in.}^3$$

- Maximum moment in the plate based on the 1.5 in. edge distance to the bolt centerline:

$$M_{u,plate} = T_{u,bolt}(1.5 \text{ in.}) = (1,333 \text{ lb/bolt})(1.5 \text{ in.}) = 1,999 \text{ lb-in.}$$

- Bending stress in the plate:

$$f_b = \frac{M_u}{Z} = \frac{1,999 \text{ lb-in.}}{0.1055 \text{ in.}^3} = 18,958 \text{ psi}$$

- Bending stress capacity of the ASTM A36 plate:

$$F_b = \Phi F_y = 0.9(36,000 \text{ psi}) = 32,400 \text{ psi}$$

- Steel plate is adequate, $F_b > f_b \rightarrow \text{OK}$



Proportioning and Design: Vessel Support and Attachments

Connections of the Vessel Leg – Connection Plates (Continued)

- ANSI/AISC 360 Equation 9-20 permits prying action to be neglected if plates meets minimum thickness requirement:

$$t_{min} = \sqrt{\frac{4.44Tb'}{pF_u}}, \text{ where } p = 3 \text{ in. is the tributary length per pair of bolts.}$$

$$b' = (b - db/2) = (1.5 \text{ in.} - 0.625 \text{ in.}/2) = 1.188 \text{ in.}$$

$$t_{min} = \sqrt{\frac{4.44Tb'}{pF_u}} = \sqrt{\frac{(4.44)(1,333 \text{ lb/bolt})(1.188 \text{ in.})}{(3 \text{ in.})(58,000 \text{ psi})}} = 0.201 \text{ in.}$$

- $t_{min} = 0.201 \text{ in.}$ is less than the 0.375-inch thickness provided for the connection plates. Thus, prying action need not be considered further.



Proportioning and Design: Vessel Support and Attachments

Connections of the Vessel Leg – Welds

- The vessel legs have two welds at each end: the welds to the vessel body, and the welds to the upper connection plate.
- The outer diameter of the vessel leg is $d = 2.38$ in. The weld properties are simplified by assuming a weld of unit thickness.

$$Z_w = \frac{\pi d^2}{4} = \frac{\pi(2.38 \text{ in.})^2}{4} = 4.45 \text{ in.}^2$$

$$A = \pi d = \pi(2.38 \text{ in.}) = 7.48 \text{ in.}$$

- Shear force in the weld of unit thickness:

$$v = \frac{V_u}{A} = \frac{952 \text{ lb}}{7.48 \text{ in.}} = 127 \text{ lb/in.}$$



Proportioning and Design: Vessel Support and Attachments

Connections of the Vessel Leg – Welds (Continued)

- Tension force due to axial load in a weld of unit thickness:

$$T_a = \frac{T_u}{A} = \frac{2,666 \text{ lb}}{7.48 \text{ in.}} = 356 \text{ lb/in.}$$

- Tension force due to bending in a weld of unit thickness (at connection to the vessel):

$$T_b = \frac{M}{Z_w} = \frac{17,138 \text{ lb-in.}}{4.45 \text{ in.}^2} = 3,852 \text{ lb/in.}$$

- For a unit length, a 3/16-inch fillet weld has a capacity of:

$$\phi R_n = 1.392 DL = 1.392 (3)(1) = 4.18 \frac{\text{kip}}{\text{in.}}$$

- Thus, the 3/16-inch fillet weld is adequate.



Prescribed Seismic Forces: Supporting Frame

- Supporting frame weight, $W_{p,sup} = D_{sup} = 1,000$ lb
- Seismic design force, F_p

$$F_p = 0.4S_{DS}I_pW_p \left[\frac{H_f}{R_\mu} \right] \left[\frac{C_{AR}}{R_{po}} \right] = 0.4(1.2)(1.0)(W_p) \left[\frac{2.52}{1.48} \right] \left[\frac{1.4}{1.5} \right] = 0.762W_p \quad (\text{controlling equation})$$

$$F_{p,max} = 1.6S_{DS}I_pW_p = 1.6(1.2)(1.0)(W_p) = 1.92W_p$$

$$F_{p,min} = 0.3S_{DS}I_pW_p = 0.3(1.2)(1.0)(W_p) = 0.360W_p$$

$$F_{p,sup} = 0.762W_p = 0.762(1,000 \text{ lb}) = 762 \text{ lb} \quad (\text{controlling seismic design force})$$



Prescribed Seismic Forces: Supporting Frame

- Horizontal seismic load effect, E_h

$$Q_E = F_p = 762 \text{ lb}$$

$$E_{h,sup} = \rho Q_E = (1.0)(762 \text{ lb}) = 762 \text{ lb}$$

- Vertical seismic load effect, E_v

$$E_{v,sup} = 0.2S_{DS}D = (0.2)(1.2g)(1,000 \text{ lb}) = 240 \text{ lb}$$

- Basic Load Combinations for Strength Design to determine the design member and connection forces to be used in conjunction with seismic loads:

$$1.2D + E_v + E_h + L + 0.2S \quad (\text{Load Combination 6})$$

$$0.9D - E_v + E_h \quad (\text{Load Combination 7})$$

For nonstructural components, the terms L and S are typically zero.



Proportioning and Design: Supporting Frame

- Components to be designed
 - Beams supporting the vessel legs
 - Braces
 - Columns supporting the platform and vessel
 - Base plates and anchor bolts

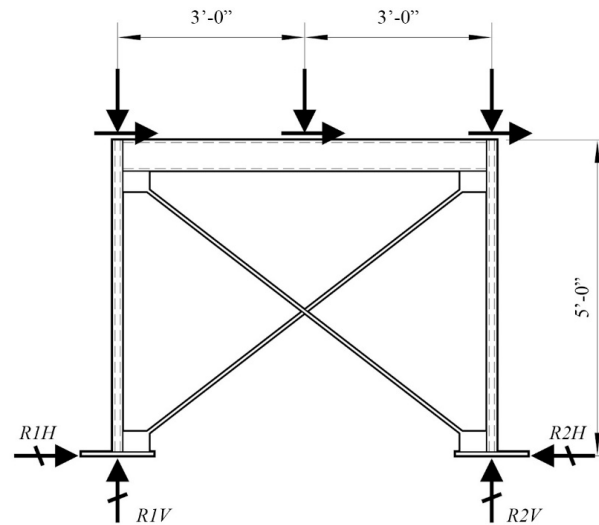

Elevated vessel supporting frame

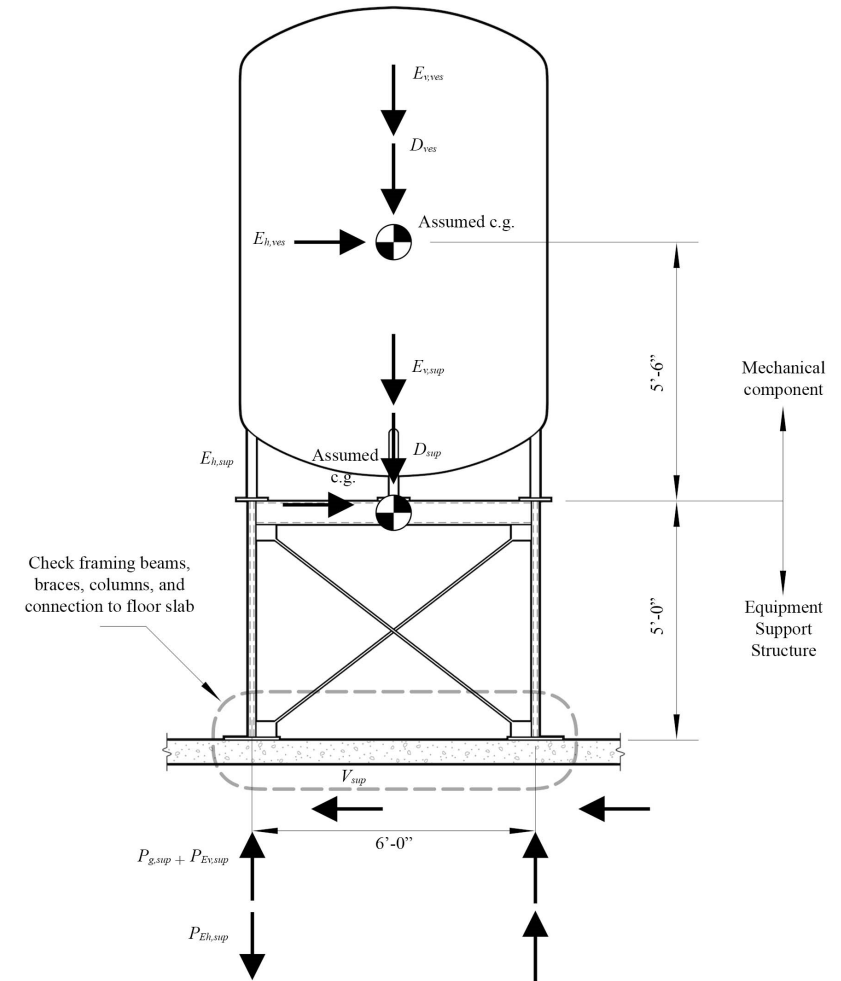

Free body diagram for supporting frame system

Proportioning and Design: Supporting Frame

Support Frame Beams

- Beam vertical load at midspan due to dead load, $P_{g,sup}$

$$P_{g,sup} = \frac{D_{ves} + D_{sup}}{4 \text{ supports}} = \frac{5,000 \text{ lb} + 1,000 \text{ lb}}{4 \text{ supports}} = 1,500 \text{ lb/support}$$

- Beam vertical load at midspan due to vertical seismic load effect, $P_{Ev,sup}$

$$P_{Ev,sup} = \frac{E_{v,ves} + E_{v,sup}}{4 \text{ supports}} = \frac{1,200 \text{ lb} + 240 \text{ lb}}{4 \text{ supports}} = 360 \text{ lb/support}$$

- Beam lateral load of the combined vessel and supporting frames, V_{sup}

$$V_{sup} = \frac{E_{h,ves} + E_{h,sup}}{4 \text{ supports}} = \frac{3,808 \text{ lb} + 762 \text{ lb}}{4 \text{ supports}} = 1,143 \text{ lb/support}$$

- Beam vertical load at midspan due to horizontal seismic load effect (Case 1), $P_{Eh,beam}$

$$P_{Eh,beam} = P_{Eh,ves} = 3,491 \text{ lb/support}$$



Proportioning and Design: Supporting Frame

Support Frame Beams (Continued)

- The HSS6x2x1/4 frame beams have the following geometric and material properties:

$$Z_{x-x} = 5.84 \text{ in.}^3, Z_{y-y} = 2.61 \text{ in.}^3, F_b = \Phi F_y = 0.9(46,000 \text{ psi}) = 41,400 \text{ psi}$$

- Moment and bending stress about the x-x axis in the beams, where $L = 6 \text{ ft}$

$$M_{x-x} = \frac{C_u L}{4} = \frac{(5,651 \text{ lb})(6 \text{ ft})(12 \text{ in./ft})}{4} = 101,718 \text{ lb-in.} \quad f_{bx} = \frac{M_{x-x}}{Z_{x-x}} = \frac{101,718 \text{ lb-in.}}{5.84 \text{ in.}^3} = 17,417 \text{ psi}$$

- Moment and bending stress about the y-y axis in the beams, where $L = 6 \text{ ft}$

$$M_{y-y} = \frac{V_u L}{4} = \frac{(1,143 \text{ lb})(6 \text{ ft})(12 \text{ in./ft})}{4} = 20,565 \text{ lb-in.} \quad f_{by} = \frac{M_{y-y}}{Z_{y-y}} = \frac{20,565 \text{ lb-in.}}{2.61 \text{ in.}^3} = 7,879 \text{ psi}$$

- Interaction of bending demand in the strong and weak axis

$$\left| \frac{f_{bx}}{F_b} + \frac{f_{by}}{F_b} \right| = \left| \frac{17,417 \text{ psi}}{41,400 \text{ psi}} + \frac{7,879 \text{ psi}}{41,400 \text{ psi}} \right| = 0.611 \leq 1.0 \quad \text{OK}$$



Proportioning and Design: Supporting Frame

Support Frame Braces

- Maximum brace force occurs when loads are resisted by two braces.
- Horizontal force:

$$V_{brace} = \frac{E_{h,ves} + E_{h,sup}}{2 \text{ braces}} = \frac{3,808 \text{ lb} + 762 \text{ lb}}{2 \text{ braces}} = 2,285 \text{ lb/brace}$$

- Length of the brace: $L = \sqrt{(5 \text{ ft})^2 + (6 \text{ ft})^2} = 7.81 \text{ ft}$
- Tension force in the brace:

$$T_u = \left(\frac{7.81 \text{ ft}}{6 \text{ ft}} \right) (2,285 \text{ lb}) = 2,974 \text{ lb} \quad (\text{tension})$$

- Nominal tensile capacity of 5/8-inch-diameter ASTM A307 threaded rods: $\phi r_n = 10,400 \text{ lb}$
- Threaded rods are adequate, $\phi r_n > T_u$, $10,400 \text{ lb} > 2,974 \text{ lb} \rightarrow \text{OK}$



Proportioning and Design: Supporting Frame

Support Frame Columns

- HSS2x2x1/4 columns support vertical loads from vessel and frame. Column length, $L = 5$ ft.
- Overturning moment:

$$M = (10.5 \text{ ft})(E_{h,ves}) + (5.0 \text{ ft})(E_{h,sup}) = (10.5 \text{ ft})(3,808 \text{ lb}) + (5.0 \text{ ft})(762 \text{ lb}) = 43,796 \text{ lb-ft}$$

- Maximum T-C loads in the columns due to overturning, where $d = (6 \text{ ft})\sqrt{2} = 8.48 \text{ ft}$

$$P_{Eh,col} = \frac{M}{d} = \frac{43,796 \text{ lb-ft}}{8.48 \text{ ft}} = 5,161 \text{ lb}$$

- The vertical gravity load in each leg is $P_{g,sup} = 1,500 \text{ lb/support}$ and $P_{Ev,sup} = 360 \text{ lb/support}$.
- The compression load on the columns is: $C_u = 1.2(P_{g,sup}) + P_{Ev,sup} + P_{Eh,col} = 7,321 \text{ lb}$
- The tension load on the columns is: $C_u = 0.9(P_{g,sup}) - P_{Ev,sup} - P_{Eh,col} = -4,171 \text{ lb}$
- The capacity of the HSS2x2x1/4 column is 38,300 lb. Therefore, it is adequate.



Proportioning and Design: Supporting Frame

Anchor Bolts

- The combination that results in net tension on the anchors will govern. Thus, the Load Combination 7 including overstrength is applied: $0.9D - E_v + E_{mh}$ where $E_{mh} = \Omega_{op} Q_E$

- Vertical design tension force:

$$T_u = 0.9(P_{g,sup}) - P_{Ev,sup} - \Omega_{op} P_{Eh,col}$$

$$T_u = 0.9(1,500 \text{ lb}) - 360 \text{ lb} - (2.0)(5,161 \text{ lb}) = -9,333 \text{ lb}$$

- Horizontal design shear force:

$$V_u = \Omega_{op} V_{Eh,col} = (2.0)(1,143 \text{ lb}) = 2,285 \text{ lb}$$

- When comparing the support frame column forces to the connection to the floor slab forces, the tension force increases by 124%, and the shear force increases by 100%.



Questions?



FEMA



Building Seismic
Safety Council



DISCLAIMER

- NOTICE: Any opinions, findings, conclusions, or recommendations expressed in this publication do not necessarily reflect the views of the Federal Emergency Management Agency. Additionally, neither FEMA nor any of its employees make any warranty, expressed or implied, nor assume any legal liability or responsibility for the accuracy, completeness, or usefulness of any information, product or process included in this publication.
- The opinions expressed herein regarding the requirements of the *NEHRP Recommended Seismic Provisions*, the referenced standards, and the building codes are not to be used for design purposes. Rather the user should consult the jurisdiction's building official who has the authority to render interpretation of the code.
- This training material presentation is intended to remain complete in its entirety even if used by other presenters. While the training material could be tailored for use in other presentations, we caution users to account for issues of completeness and interpretation if only part of the material is used. We also strongly suggest users give proper credit/citation to this presentation and its author.



FEMA



Building Seismic
Safety Council

